

Register your product and get support at
www.philips.com/welcome



42PFL6556/V7

46PFL6556/V7

55PFL6556/V7

EN User manual

PHILIPS

Contents

1	Notice	2
2	Important	3
3	Your TV	5
	TV controls	5
	Remote Control	5
	Remote control usage	6
4	Use your TV	7
	Switch channels	7
	Watch connected devices	8
	Adjust TV volume	8
5	Use more of your TV	9
	Access TV menus	9
	Rename devices from the home menu	9
	Remove devices from the home menu	10
	Change picture and sound setting	10
	Create and use lists of favourite channels	12
	Display the TV clock	13
	Use timers	13
	Lock unsuitable content	14
	View Scenea	14
	Play photos, music and videos on USB storage devices	15
	Update the TV software	17
	Change TV preferences	17
	Start a TV demo	18
	Reset the TV to factory settings	18
	Reinstall the TV	18
6	Install channels	19
	Automatically install channels	19
	Manually install channels	19
	Rename channels	19
	Rearrange channels	20

7	Connect devices	21
	Back connections	21
	Side connections	21
	Connect a computer	23
	Use Philips EasyLink	23
	Use a Kensington lock	24
8	Product information	25
	Supported display resolutions	25
	Multimedia	25
	Tuner/Reception/Transmission	25
	Remote control	25
	Power	25
	Supported TV mounts	25
	Product specification	26
9	Troubleshooting	27
	General TV issues	27
	TV channel issues	27
	Picture issues	27
	Sound issues	28
	HDMI connection issues	28
	Computer connection issues	28
	Contact us	28

1 Notice

Pixel characteristics

This LCD product has a high number of colour pixels. Although it has effective pixels of 99.999% or more, black dots or bright points of light (red, green or blue) may appear constantly on the screen. This is a structural property of the display (within common industry standards) and is not a malfunction.

Terms of warranty

- Risk of injury, damage to TV or void of warranty! Never attempt to repair the TV yourself.
- Use the TV and accessories only as intended by the manufacturer.
- The caution sign printed on the back of the TV indicates risk of electric shock. Never remove the TV cover. Always contact Philips Customer Support for service or repairs.



- Any operation expressly prohibited in this manual, or any adjustments and assembly procedures not recommended or authorised in this manual shall void the warranty.

2 Important

Read and understand all instructions before you use your TV. If damage is caused by failure to follow instructions, the warranty does not apply.

Safety

Risk of electric shock or fire!

- Never expose the TV to rain or water. Never place liquid containers, such as vases, near the TV. If liquids are spilt on or into the TV, disconnect the TV from the power outlet immediately. Contact Philips Consumer Care to have the TV checked before use.
- Never place the TV, remote control or batteries near naked flames or other heat sources, including direct sunlight. To prevent the spread of fire, keep candles or other flames away from the TV, remote control and batteries at all times.



- Never insert objects into the ventilation slots or other openings on the TV.
- When the TV is swivelled ensure that no strain is exerted on the power cord. Strain on the power cord can loosen connections and cause arcing.

Risk of short circuit or fire!

- Never expose the remote control or batteries to rain, water or excessive heat.
- Avoid force coming onto power plugs. Loose power plugs can cause arcing or fire.

Risk of injury or damage to the TV!

- Two people are required to lift and carry a TV that weighs more than 25 kg or 55 lbs.
- When stand mounting the TV, use only the supplied stand. Secure the stand to the TV tightly. Place the TV on a flat, level surface that can support the combined weight of the TV and the stand.
- When wall mounting the TV, use only a wall mount that can support the weight of the TV. Secure the wall mount to a wall that can support the combined weight of the TV and wall mount. PE Electronics Ltd bears no responsibility for improper wall mounting that result in accident, injury or damage.

Risk of injury to children!

Follow these precautions to prevent the TV from toppling over and causing injury to children:

- Never place the TV on a surface covered by a cloth or other material that can be pulled away.
- Ensure that no part of the TV hangs over the edge of the surface.
- Never place the TV on tall furniture (such as a bookcase) without anchoring both the furniture and TV to the wall or a suitable support.
- Educate children about the dangers of climbing on furniture to reach the TV.

Risk of swallowing batteries!

- The product/remote control may contain a coin-type battery, which can be swallowed. Keep the battery out of reach of children at all times!

Risk of overheating!

- Never install the TV in a confined space. Always leave a space of at least 4 inches or 10 cm around the TV for ventilation. Ensure curtains or other objects never cover the ventilation slots on the TV.

Risk of damage to the TV!

- Before you connect the TV to the power outlet, ensure that the power voltage matches the value printed on the back of the TV. Never connect the TV to the power outlet if the voltage is different.

Risk of injury, fire or power cord damage!

- Never place the TV or any objects on the power cord.
- To easily disconnect the TV power cord from the power outlet, ensure that you have full access to the power cord at all times.
- When you disconnect the power cord, always pull the plug, never the cable.
- Disconnect the TV from the power outlet and antenna before lightning storms. During lightning storms, never touch any part of the TV, power cord or antenna cable.

Risk of hearing damage!

- Avoid using earphones or headphones at high volumes or for prolonged periods of time.

Low temperatures

- If the TV is transported in temperatures below 5°C or 41°F, unpack the TV and wait until the TV temperature matches room temperature before connecting the TV to the power outlet.

Screen care

- Avoid stationary images as much as possible. Stationary images are images that remain on-screen for extended periods of time. Examples include: on-screen menus, black bars and time displays. If you must use stationary images, reduce screen contrast and brightness to avoid screen damage.
- Unplug the TV before cleaning.
- Clean the TV and frame with a soft, damp cloth. Never use substances such as

alcohol, chemicals or household cleaners on the TV.

- Risk of damage to the TV screen! Never touch, push, rub or strike the screen with any object.
- To avoid deformations and colour fading, wipe off water drops as soon as possible.

Disposal of your old product and batteries



Your product is designed and manufactured with high quality materials and components, which can be recycled and reused.

3 Your TV

Congratulations on your purchase, and welcome to Philips! To fully benefit from the support that Philips offers, register your TV at www.philips.com/welcome.

TV controls

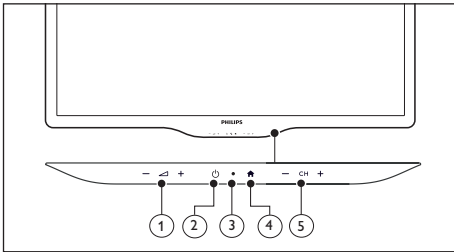

- ① +/-: Adjust volume.
- ② (Power): Switch the TV on or off.
- ③ Standby indicator and remote controller sensor.
- ④ (Home): Access the home menu.
- ⑤ CH +/-: Switch channels.

Remote Control

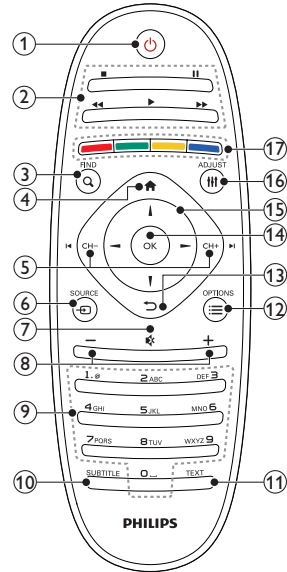

- ① (Standby-On)
 - Switch the TV on or to standby.
- ② **Play buttons**
 - Control video or music.
- ③ **FIND**
 - Access the menu to select a TV channel list.
- ④ (Home)
 - Access the home menu.
- ⑤ **CH - / CH +** (Previous/Next)
 - Switch channels or navigate through menu pages, tracks, albums or folders.
- ⑥ **SOURCE**
 - Select connected devices.
- ⑦ **MUTE**
 - Mute or restore audio.

- ⑧ +/-
 - Adjust volume.
- ⑨ 0-9 **Numeric buttons**
 - Select channels.
- ⑩ **SUBTITLE**
 - No function.
- ⑪ **TEXT**
 - No function.
- ⑫ ☰ **OPTIONS**
 - Access options for the current activity or selection.
- ⑬ ↶
 - Return to the previous menu or exit a function.
- ⑭ **OK**
 - Confirm an entry or selection.
- ⑮ ▲▼◀▶ (**Navigation buttons**)
 - Navigate through menus and select items.
- ⑯ ≡ **ADJUST**
 - Access the menu to adjust settings.
- ⑰ **Colour buttons**
 - Select tasks or options

Remote control usage

When you use the remote control, hold it close to the TV and point it at the remote control sensor. Make sure that the line-of-sight between the remote control and TV is not blocked by furniture, walls or other objects.

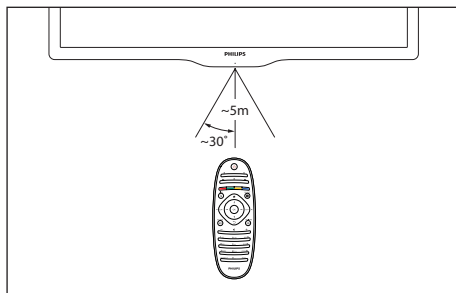

4 Use your TV

This section helps you perform basic TV operations.

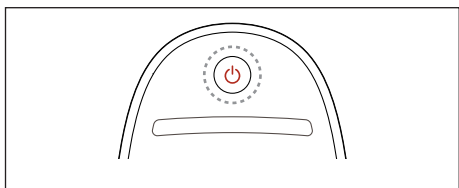
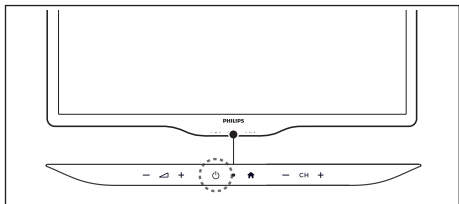

Switch your TV on

- Press the power switch on the TV.

Switch your TV to standby

- Press **⏻ (Standby-On)** on the remote control again.
- The remote control sensor on the TV switches to red.

Switch your TV off

- Press the power switch on the TV again.
- The remote control sensor on the TV switches off.

Tip

- Your product consumes very little power in standby mode, but it will still consume a little power. Unplug the power plug of your TV from the wall socket if it is not to be used for long time.

Switch channels

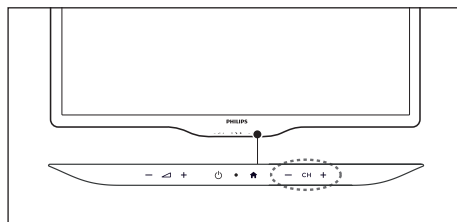

- Press **CH +/-** on the TV.

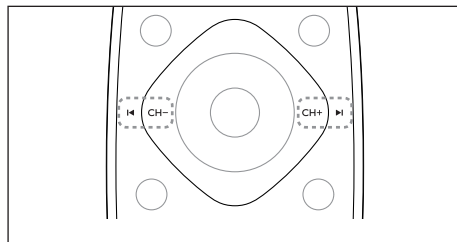

- Press **CH+** or **CH-** on the remote control.

Other ways to switch channels

- Enter a channel number using the **Numeric buttons**.
- Press **↩ (BACK)** on the remote control to return to the previous channel.

View channel preview

You can view a preview of all available channels with the channel grid.

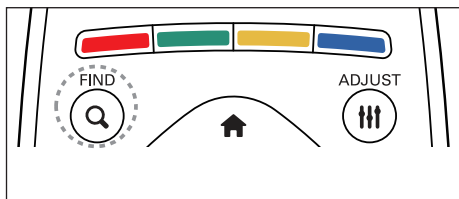

- Press **FIND**.
 - ↳ The channel grid appears.
 - ↳ To preview a channel, select it.
 - ↳ To watch a channel, select it, then press **OK**.

Note

- This feature is available depending on model.

Watch connected devices

Note

- Before you select a device as a source, switch the device on.

Select a device from the source list

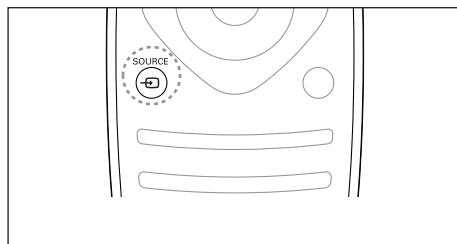

- 1 Press **SOURCE**.
 - ↳ The source list appears.
- 2 Press **▲▼** to select a device.
- 3 Press **OK** to confirm your choice.
 - ↳ The TV switches to the selected device.

Adjust TV volume

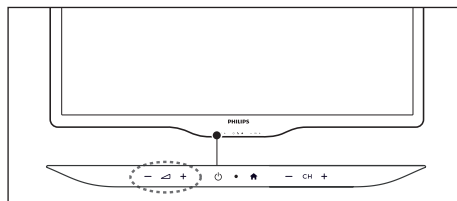

- Press **+/-** on the TV.

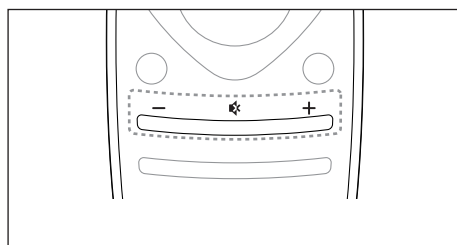

- Press **+/-** on the remote control.

To mute or unmute sound

- Press **🔇** to mute the sound.
- Press **🔇** again to restore the sound.

5 Use more of your TV

Access TV menus

Menus help you to install channels, change picture and sound settings and access other features.

- 1 Press .
↳ The menu screen appears.

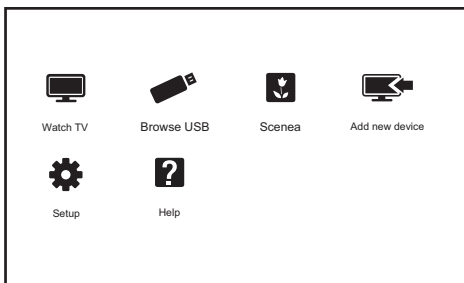

- 2 Select one of the following, then press **OK**.
 - **[Watch TV]**: If a source other than antenna is selected, switch back to the antenna source
 - **[Add new device]**: Add new devices to the home menu.
 - **[Setup]**: Access menus to change picture, sound and other settings.
 - **[Scenea]**: Switch on Scenea wallpaper.
 - **[Browse USB]**: View photos and play music and movies contained in USB storage devices.

- 3 Add device to the home menu.
After you connect a device, add it to the home menu.

- Press .
- Select **[Add new device]**.
- Follow the onscreen instructions to add the device to the home menu.
 - ↳ The device is displayed in the home menu.
- To watch the device, switch it on, then select it in the home menu.
- You can also select the device with the source button (see 'Select a device from the source list' on page 8).

Rename devices from the home menu

After you add a new device to the home menu, you can rename it to your preference.

Note

- The device name can be up to 16 characters long.

- 1 Press .
- 2 Select a device to rename.
- 3 Press **≡ OPTIONS**.
 - ↳ The options menu appears.
- 4 Select **[Rename device]**, then press **OK**.
 - ↳ A text input box appears.
- 5 Select characters each character, then press **OK** to confirm.
- 6 When the new name is complete, select **[Done]**, then press **OK**.

Remove devices from the home menu

If a device is no longer connected to the TV, remove it from the home menu.

- 1 Press **▲**.
- 2 Select a device to remove.
- 3 Press **≡** **OPTIONS**.
- 4 Select **[Remove device]**, then press **OK**.
- 5 Select **[Remove]**, then press **OK**.
↳ The selected device is removed from the home menu.

Change picture and sound setting

Change picture and sound settings to suit your preferences. You can apply pre-defined settings or change settings manually.

Note

- While you watch TV or external devices, press **≡** **ADJUST**, then select **[Smart picture]** or **[Smart sound]** for quick access to picture and sound settings.
- Hue-Active in NTSC channels Only.

Use settings assistant

Use the settings assistant to guide you through the picture and sound settings.

- 1 Press **▲**.
- 2 Select **[Setup] > [Quick picture and sound settings]**, then press **OK**.
- 3 Select **[Continue]**, then press **OK**.
↳ The **[Settings assistant]** menu appears.
- 4 Follow the onscreen instructions to choose your preferred picture settings.

Use smart picture

Use smart picture to apply pre-defined picture settings.

- 1 Press **≡** **ADJUST**.
- 2 Select **[Smart picture]**, then press **OK**.
- 3 Select one of the following settings, then press **OK**.
 - **[Personal]**: Apply your customised picture settings.
 - **[Vivid]**: Rich and dynamic settings, ideal for daytime.
 - **[Natural]**: Natural picture settings.
 - **[Cinema]**: Ideal settings for movies.
 - **[Game]**: Ideal settings for games.
 - **[Energy saving]**: Settings that conserve the most energy.
 - **[Standard]**: Default settings that suit most environments and types of video.
 - **[Photo]**: Ideal settings for photos.
 - **[Custom]**: Customise and store your personal picture settings.

Manually adjust picture setting

- 1 Press **▲**.
- 2 Select **[Setup] > [TV settings] > [Picture]**, then press **OK**.
- 3 Select one of the following settings, then press **OK**.
 - **[Smart picture]**: Access predefined smart picture settings.
 - **[Reset]**: Reset to factory default settings.
 - **[Contrast]**: Adjust the intensity of backlight areas, while the video contents are kept unchanged.
 - **[Brightness]**: Adjust the intensity and details of dark areas.
 - **[Colour]**: Adjust colour saturation.
 - **[Hue]**: Compensate for colour variations.
 - **[Sharpness]**: Adjust sharpness in the image.

- **[Noise reduction]:** Filter and reduce noise in an image.
- **[Colour Temperature]:** Adjust the colour balance in an image.
- **[Custom Colour Temperature]:** Customize Colour Temperature. (Only available if **[Colour Temperature]** > **[Custom]** is selected).
- **[Pixel Plus HD]:** Fine-tune each pixel to match surrounding pixels. This setting produces a brilliant, high-definition image.
 - **[HD Natural Motion]:** (For Pixel Plus HD) Minimise juddering effects and enhance picture smoothness.
 - **[Advance sharpness]:** Enable superior picture sharpness.
 - **[Dynamic contrast]:** Enhance contrast. **[Medium]** setting is recommended.
 - **[Dynamic backlight]:** Adjust brightness of the TV backlight to match lighting conditions.
 - **[Colour enhancement]:** Make colours more vivid and improve the details in bright colours. You can switch this feature on or off.
 - **[Gamma]:** Adjust the midtone intensity in the picture. Black and white are not affected.
- **[PC mode]:** Adjust the picture when a PC is connected to the TV via HDMI or DVI.
- **[Picture format]:** Change the picture format.
- **[Screen edges]:** Adjust the viewing area. (when set to maximum, you may see noise or the rough edge of an image).
- **[Picture shift]:** Adjust the picture position for all picture formats except for **[Unscale]**, **[4: 3]** and **[Wide screen]** in antenna source.

Summary of picture formats

The following picture settings can be configured.



Note

- Depending on the format of the picture source, some picture settings are not available.



[Super zoom]: Remove the black bars on the side of 4:3 broadcasts. There is minimal distortion.



[4:3]: Show the classic 4:3 format.



[Unscaled]: Allow maximum sharpness. Some distortion may be present due to the broadcaster's systems. Set your PC resolution to wide screen mode for best results.



[Subtitle Zoom]: Fit a 4:3 format screen in the whole display so that the subtitles are visible by cutting some top portion of the screen.



[Movie expand 14:9]: Scale 4:3 formats to Movie Expand 14:9.

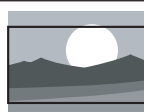

[Movie expand 16:9]: Scale 4:3 formats to Movie Expand 16:9.



[Wide screen]: Scale 4:3 format to 16:9.

Change picture format

- 1 Press **⏏** **ADJUST**.
- 2 Select **[Picture format]**, then press **OK**.
- 3 Select a picture format, then press **OK**.

Use smart sound

Use smart sound to apply pre-defined sound settings.

- 1 Press **ADJUST**.
- 2 Select **[Smart sound]**, then press **OK**.
- 3 Select one of the following settings, then press **OK**.
 - **[Personal]**: Apply the settings that were customised in the sound menu.
 - **[Standard]**: Settings that suit most environments and types of audio.
 - **[News]**: Ideal settings for spoken audio, such as news.
 - **[Cinema]**: Ideal settings for movies.
 - **[Game]**: Ideal settings for games.
 - **[Drama]**: Ideal settings for drama programmes.
 - **[Sports]**: Ideal settings for sports programmes.

Manually adjust sound settings

- 1 Press **HOME**.
- 2 Select **[Setup] > [TV settings] > [Sound]**, then press **OK**.
- 3 Select one of the following settings, then press **OK**.
 - **[Smart sound]**: Access predefined smart sound settings.
 - **[Reset]**: Reset to factory default settings.
 - **[Clear sound]**: Enhance the sound clarity.
 - **[Bass]**: Adjust the bass level.
 - **[Treble]**: Adjust the treble level.
 - **[Surround]**: Switch on spatial sound.
 - **[Auto volume levelling]**: Automatically reduce sudden volume changes, for example when switching channels.
 - **[Balance]**: Adjust the balance of the right and left speakers.

Use the Options menu

Visit options relevant to current action or selection.

- 1 While you watch TV, press **OPTION**.
 - ↳ The TV options menu appears.
- 2 Select one of the following options, then press **OK**.
 - **[Key beep]**: Switch on audio feedback when buttons are pressed on the remote control or TV.
 - **[Clock]**: Display time.
 - **[Status]**: Display information concerning currently viewing channel.
 - **[Ecology]**: Relevant setups as below available.
 - **[Energy Saving]**: This feature conserve most energy.
 - **[Mute Screen]**: The TV display will turn off and only sound is audible. Conserve maximum energy.

Note

- Press any key of remote to release the TV set from Mute Screen.

Tip

- Select the **OPTION** function by pressing the **OPTION** button on your remote controller.

Create and use lists of favourite channels

You can create a list of your preferred TV channels so that you can find those channels easily.

View only the list of favourite channels

- 1 While you watch TV, press **FIND**.
 - ↳ The channel matrix menu is displayed.

- 2 Press **≡** **OPTIONS**.
- 3 Select **[Select list]** > **[Favourites]**, then press **OK**.
 - ↳ Only channels in the favourites list appear in the channel grid.

Note

- The favourites channel grid is empty until you add channels into the favourites list.

View all channels

You can exit the favourites list, and view all installed channels.

- 1 While you watch TV, press **Q** **FIND**.
 - ↳ The channel matrix menu is displayed.
- 2 Press **≡** **OPTIONS**.
- 3 Select **[Select list]** > **[All]**, then press **OK**.
 - ↳ All channels are displayed in the channel grid.

Note

- All favourite channels are marked by an asterisk when you view the channel grid.

Manage the favourites list

- 1 While you watch TV, press **Q** **FIND**.
 - ↳ The channel matrix menu appears.
- 2 Press **≡** **OPTIONS**.
- 3 Select **[Mark favourite]** / **[Unmark favourite]**, then press **OK**.
 - ↳ The channel is marked or unmarked from the favourite list.

Display the TV clock

You can display a clock on the TV screen.

Set the TV clock manually

- 1 Press **▲**.
- 2 Select **[Setup]** > **[TV settings]** > **[Preferences]** > **[Clock]**.
- 3 Select **[Time]** or **[Date]**, then press **OK**.
- 4 Press the **Navigation buttons** to set the time or date.
- 5 Select **[Done]**, then press **OK**.
- 6 Press **▲** to exit.

Display the TV clock

- 1 While you watch TV, press **≡** **OPTIONS**.
 - ↳ The options menu is displayed.
- 2 Select **[Clock]**.
- 3 Press **OK**.

Note

- To disable the clock, repeat the procedure.

Use timers

You can set sleep timers to switch the TV to standby at a specified time.

Tip

- Set the TV clock before you use timers.

Automatically switch the TV to standby(sleep timer)

Sleep timer switches the TV to standby after a pre-defined duration.



Tip

- You can switch off your TV earlier or reset the sleep timer during the countdown.

- 1 Press **▲**.
- 2 Select **[Setup] > [TV settings] > [Preferences] > [Sleep timer]**.
↳ The **[Sleep timer]** menu appears.
- 3 Select a value between zero and 180 minutes.
↳ If you select zero, the sleep timer switches off.
- 4 Press **OK** to switch on the sleep timer.
↳ The TV switches to standby after the specified time.

Lock unsuitable content

You can prevent your children from watching certain programmes or channels by locking the TV controls.

Set or change code

- 1 Press **▲**.
- 2 Select **[Setup] > [Channel settings] > [Child lock]**.
- 3 Select **[Set code]** or **[Change code]**.
↳ The **[Set code] / [Change code]** menu appears.
- 4 Enter your code using the **Numeric buttons**.
↳ Follow the on-screen instructions to create or change your PIN code.



Tip

- If you forget your code, enter '8888' to override any existing codes.

Lock or unlock one or more channels

- 1 Press **▲** > **[Setup] > [Channel settings] > [Child lock] > [Channel lock]**.
↳ A list of channels is displayed.
- 2 Select the channel that you want to lock or unlock, then press **OK**.
↳ The first time you lock or unlock a channel, you are prompted to enter your PIN code.
- 3 Enter your code and press **OK**.
↳ If the channel is locked, a lock icon is displayed.
- 4 Repeat the process to lock or unlock more channels.



Note

- When you switch channels with **CH -** or **CH +**, the locked channels are skipped.
- When you access the locked channels from the channel grid, you are prompted to enter your PIN code.

View Scenea

You can display a default picture as the wallpaper on your TV. You can also load another picture as the wallpaper.

If the sleeptimer is off, the wallpaper is displayed for 240 minutes. Otherwise, it is displayed for the duration of the sleeptimer.

Switch on Scenea

- 1 Press **▲**.
- 2 Select **[Scenea]**, then press **OK**.
↳ If no picture has been set, the default picture is displayed.
↳ If a customised Scenea picture is loaded, that picture is displayed.



Note



- Scenea feature is not available when the set is in Shop mode.

Customise the Scenea picture

You can load another picture as the wallpaper.

Note

- When you load a new Scenea picture, it overrides the current Scenea picture.
- To use another picture as the wallpaper, you need a USB storage device that contains a picture that is less than 1 MB in size.

- 1 Load a picture smaller than 1MB in size into a USB storage device.
- 2 Connect the USB storage device to the TV.
- 3 Press .
- 4 Select [**Browse USB**], then press **OK**.
- 5 Select a picture, then press  **OPTIONS**.
- 6 Select [**Set as Scenea**], then press **OK**.
↳ A confirmation message is displayed.

Play photos, music and videos on USB storage devices

Video file format supported by USB devices:

- Supported storage devices: USB (for FAT or FAT 32 format only)
- Supported multimedia file format
- Image: JPEG
- Audio: MP3
- Video: MPEG 2/MPEG 4 , H.264 , WMV

Caution

- Philips is not responsible if the USB storage device is not supported, nor is it responsible for damage or loss of data from the device.



Note

- When USB is connected, TV set will go to USB source after every stand-by.





Connect a USB storage device to play photos, music or videos stored on it.

- 1 Switch on the TV.
- 2 Connect the USB device to the USB port on the side of your TV.
- 3 Press .
- 4 Select [**Browse USB**], then press **OK**.
↳ The USB browser appears.

View photos

- 1 In the USB browser, select [**Picture**], then press **OK**.
- 2 Select a photo or a photo album, then press **OK** to view the photo enlarged to fill the TV screen.
 - To view the next or previous photo, press  .

View a slide show of your photos

- 1 When a full screen image of a photo is displayed, press **OK**.
↳ A slide show begins from the selected photo.
- 2 Press the following buttons to control play:
 -  to play.
 -  to pause.
 -  or  to play the previous or next photo.
 -  to stop.

Change slide show settings

- 1 While you view a slide show, press  **OPTIONS**.
↳ The slide show options menu is displayed.

- 2 Select one of the following, then press **OK**.
- **[Start/Stop slideshow]**: Start or stop slideshow.
 - **[Slideshow transitions]**: Set the transition from one picture to the next.
 - **[Slideshow frequency]**: Select the display time for each photo.
 - **[Repeat]/[Play once]**: Play once or repeatedly.
 - **[Shuffle on]/[Shuffle off]**: Play in sequence or at random.
 - **[Rotate image]**: Rotate photo.
 - **[Set as Scenea]**: Set this picture as wallpaper.
 - **[Show info]**: Display the picture name, date, size and next picture in the slide show.

 **Note**

- **[Rotate image]** and **[Show info]** appear only when the slideshow is paused.

Listen to music

- 1 In the USB browser, select **[Music]**, then press **OK**.
- 2 Select a music track or album, then press **OK** to play.

Change music settings

While you play music, press **≡ OPTIONS** to access one of the following settings, then press **OK**.

- **[Stop playback]**: Stop music play.
- **[Repeat]/[Play once]**: Play a song once or repeatedly.
- **[Shuffle on] / [Shuffle off]**: Play songs in sequence or at random.
- **[Show info]**: Display the file name.
- **[Sound]**: Change sound settings.

Playing music while viewing slideshow.

You can view slideshow and play background music at the same time.

- 1 Select one music album.
- 2 Press **OK**.
- 3 Press **↶** to go back to the USB browsing page.
- 4 Select one photo album.
- 5 Press **OK** to start playing the slideshow.

Watch video

- 1 In the USB browser, select **[Video]**, then press **OK**.
- 2 Press **OK** to play.
- 3 To control play, press the play buttons:
 - **▶** to play.
 - **⏸** to pause.
 - **⏮** or **⏭** to play the previous or next video.

Change video settings

While you play video, press **≡ OPTIONS** to access one of the following settings, then press **OK**.

- **[Stop playback]**: Stop video play.
- **[Repeat]/[Play once]**: Play once or repeatedly.
- **[Shuffle on] / [Shuffle off]**: Play in sequence or at random.
- **[Full Screen]/[Small Screen]**: Select screen size for playing.
- **[Show info]**: Display the file name.

Disconnect a USB storage device

Caution

- Follow this procedure to avoid damage to your USB storage device.

- 1 Press **↵** to exit the USB browser.
- 2 Wait for five seconds, then disconnect the USB storage device.

Update the TV software

Philips continuously tries to improve its products and we recommend that you update the TV software when updates are available. Check www.philips.com/support for availability.

Check the current software version

- 1 Press **▲**.
- 2 Select **[Setup] > [Software update] > [Current software info]**.
 - ↳ The current software information is displayed.

Update with a USB device

- 1 Press **▲**.
- 2 Select **[Setup] > [Software update]**.
- 3 Follow the on-screen instructions to complete the update.

Note

- The TV restarts after the software update is complete.
- This feature is available depending on model.

Manually updating with USB storage device

- 1 On your PC, open a web browser and go to www.philips.com/welcome.
- 2 Search for information and software relevant to your TV set.

- 3 Find the latest updated files.
- 4 Compare versions of the software.
 - If the current software version matches the latest software update file, you do not need to update your TV software.
 - If version number of the software currently in your TV set is smaller than the latest one, please download the latest software update file to your PC.
- 5 Decompress the ZIP-file.
- 6 Copy the file to the root directory of your USB storage device.
- 7 Connect your USB storage device to the TV.
- 8 Select **[Setup] > [Software update] > [Local updates]**.
- 9 Follow the on-screen instructions to complete the update.

Note

- The TV restarts after the software update is complete.
- This feature is available depending on model.

Change TV preferences

- 1 Press **▲**.
- 2 Select **[Setup] > [TV settings] > [Preferences]**.
- 3 Select one of the following, then press **OK**.

- **[Menu language]:** Select a menu language.
- **[Sleep timer]:** Switch the TV to standby after a pre-defined duration.
- **[Location]:** Optimise TV settings for your location - home or shop.
- **[E-sticker]:** (For shop mode only) Switch the e-sticker on or off.
- **[Volume bar]:** Display the volume bar when you adjust the volume.
- **[Auto switch off]:** To conserve energy, set the TV to switch off automatically after a period of inactivity.
- **[Channel information size]:** Change the type of information that is displayed when you switch channels.
- **[Key beep]:** Enable audio feedback when you press buttons on the remote control or TV.
- **[TV position]:** Apply the best settings for your TV based on how it is mounted.
- **[Clock]:** Display or remove the time from the TV, and set clock options.

Start a TV demo

You can use demonstrations to better understand the features of your TV. Some demos are not available on certain models. Available demos are displayed in the menu list.

- 1 While you watch TV, press **▲**.
- 2 Select **[Setup] > [Watch demo]**, **OK**.
- 3 Select a demo and press **OK** to view it.

Reset the TV to factory settings

You can restore the default picture and sound settings of your TV. The channel installation settings remain the same.

- 1 Press **▲**.
- 2 Select **[Setup] > [TV settings] > [Factory settings]**, then press **OK**.
- 3 Enter the PIN code (with a default value of 8888) select **RESET**, press **OK** to start resetting previous settings.

Reinstall the TV

You can reinstall the default settings of your TV. All the changed settings will reset.

- 1 Press **▲**.
- 2 Select **[Setup] > [TV settings] > [Reinstall TV]**, then press **OK**.
- 3 Enter the PIN code (with a default value of 8888) select **Start Now**, press **OK** to start reinstalling the TV settings.

6 Install channels

The first time you set up your TV, you are prompted to select a menu language and to install TV. Afterwards, you can re-install and fine tune channels.

Automatically install channels

- 1 Press **⬆**.
- 2 Select **[Setup] > [Search for channel]**, then press **OK**.

Manually install channels

Step 1 Select your system

Note

- Skip this step if your system settings are correct.

- 1 Press **⬆**.
- 2 Select **[Setup] > [Channel settings] > [Channel installation] > [Analogue: Manual antenna installation]**.
- 3 Select the correct **[Colour system]** and **[Sound system]**.

Step 2 Search and store new TV channels

- 1 Press **⬆**.
- 2 Select **[Setup] > [Channel settings] > [Channel installation] > [Analogue: Manual antenna installation] > *[Find channel]**, then press **OK**.
 - If you know the three-digit frequency of the channel, enter it.
 - To search, select **[Search]**, then press **OK**.

- 3 When the channel is found, select **[Done]**, then press **OK**.
 - To store the channel as a new number, select **[Store as new channel]**, then press **OK**.
 - To store the channel as the previously selected channel, select **[Store current channel]**, then press **OK**.

Step 3 Fine-tune analogue channels

- 1 Press **⬆**.
- 2 Select **[Setup] > [Channel settings] > [Channel installation] > [Analogue: manual install] > [Fine-tune]**, then press **OK**.
- 3 Press **▲▼** to fine-tune the channel.
- 4 When fine tune is complete, select **[Done]**, then press **OK**.

Rename channels

You can rename channels. The name appears when you select the channel.

- 1 While you watch TV, press **Q FIND**.
 - ↳ The channel matrix menu is displayed.
- 2 Select the channel to rename.
- 3 Press **≡ OPTIONS**.
 - ↳ The channel options menu appears.

- 4 Select [**Rename channel**], then press **OK**.
↳ A text input box appears.
- 5 Press **▲▼◀▶** to select each character, then press **OK**.
- 6 When the name is complete, select [**Done**], then press **OK**.

Rearrange channels

After you install channels, you can rearrange the order in which they appear:

- 1 While you watch TV, press **Q FIND**.
↳ The channel matrix menu is displayed.
- 2 Press **:≡ OPTIONS**.
↳ The channel options menu appears.
- 3 Select [**Reorder**], then press **OK**.
- 4 Select the channel to rearrange, then press **OK**.
↳ The selected channel is highlighted.
- 5 Move the highlighted channel to its new location, then press **OK**.
- 6 Press **:≡ OPTIONS**.
- 7 Select [**Done reordering**], then press **OK**.

7 Connect devices

This section describes how to connect devices with different connectors.

Note

- You can use different types of connectors to connect a device to your TV.

Back connections

- VIDEO OUTPUT**
Video output from analogue devices such as VCRs.

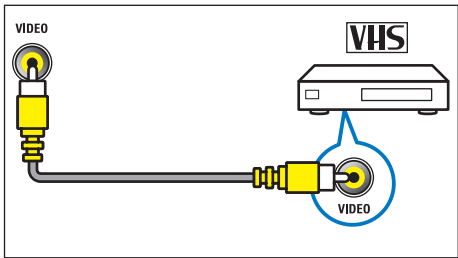

- DIGITAL AUDIO OUT**
Digital audio output to home theatres and other digital audio systems.

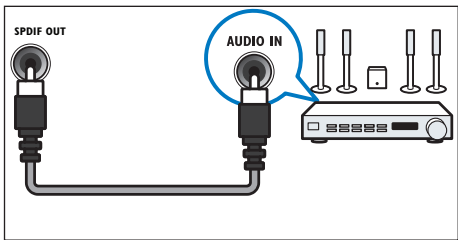

- CVI/AV2 (Y Pb Pr and AUDIO L/R)**
Analogue audio and video input from analogue or digital devices such as DVD players or game consoles.

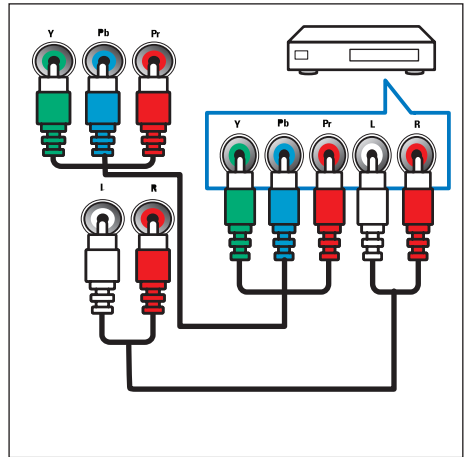

- SERV. U**
For use by service personnel only.
- PC IN (VGA and AUDIO IN)**
Audio and video input from a computer. (Note: This machine is a 6 degree tilt VGA Interface design, aimed at the interface when you plug insert)

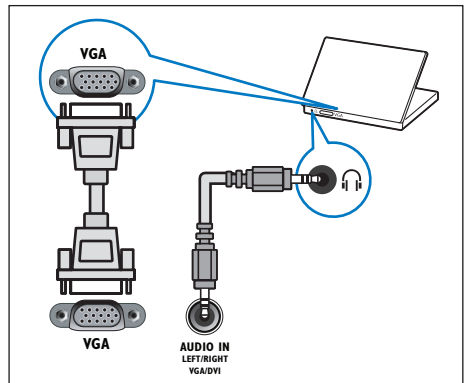

Side connections

- HDMI**
Digital audio and video input from high-definition digital devices such as Blu-ray players.

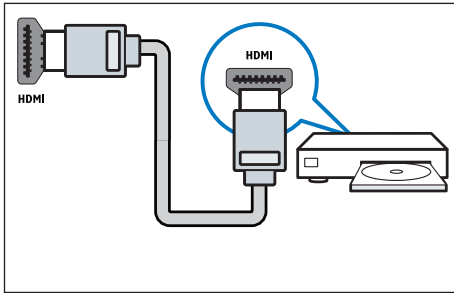

② AUDIO L/R

Audio input from analogue devices connected to VIDEO.

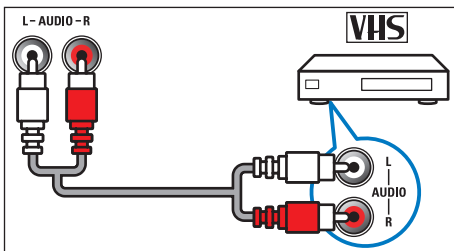

③ VIDEO(AV1)

Composite video input from analogue devices such as VCRs.

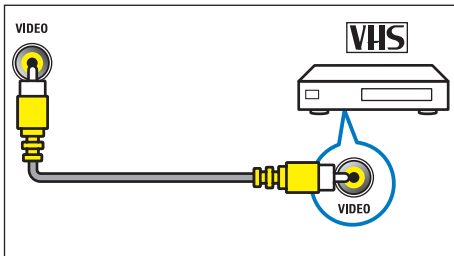

④ TV ANTENNA

Signal input from an antenna, cable or satellite.

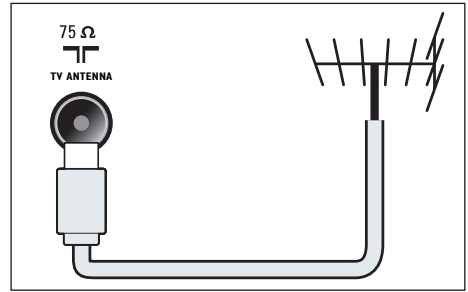

⑤ (Headphone)

Stereo audio output to headphones or earphones.

Note

- Headphones plugged in, TV speakers will automatically mute

⑥ USB

Data input from USB storage devices.

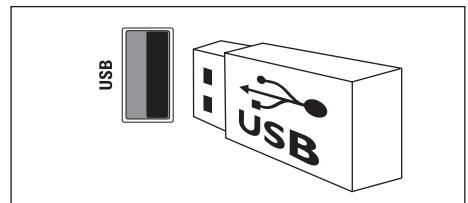

Connect a computer

Before you connect a computer to the TV

- Set the screen refresh rate on your computer to 60Hz.
- Select a supported screen resolution on your computer.

Connect a computer with one of the following connectors:

Note

- Connections via DVI or VGA require an additional audio cable.

• HDMI cable

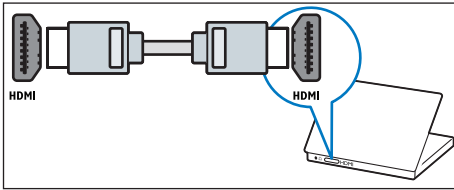

• DVI-HDMI cable

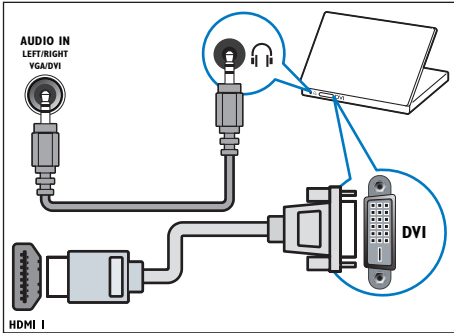

• HDMI cable and HDMI-DVI adaptor

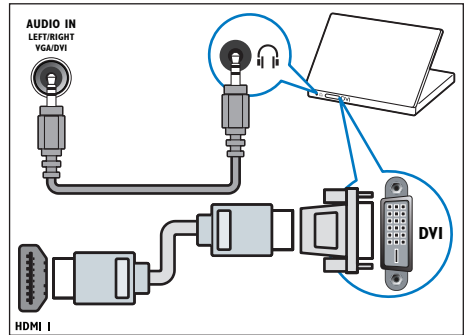

• VGA cable

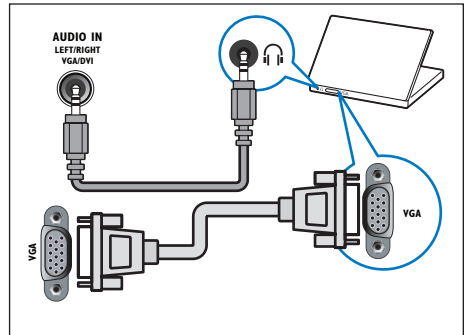

Use Philips EasyLink

Get the most out of your HDMI-Consumer Electronic Control (CEC) compliant devices with Philips EasyLink enhanced control features. If your HDMI-CEC compliant devices are connected through HDMI, you can control them at the same time with your TV remote control.

To enable Philips EasyLink, you need to:

- Connect at least two HDMI-CEC compliant devices through HDMI
- Configure each HDMI-CEC compliant device properly
- Switch on EasyLink

☰ Note

- The EasyLink-compliant device must be switched on and selected as the source.
- Philips does not guarantee 100% interoperability with all HDMI CEC devices.

Switch on or off EasyLink

When you play an HDMI-CEC compliant device, the TV switches on from standby, and switches to the correct source.

☰ Note

- If you do not intend to use Philips EasyLink, switch it off.

- 1 Press **⬆**.
- 2 Select **[Setup] > [TV settings] > [EasyLink] > [EasyLink]**.
- 3 Select **[On]** or **[Off]**, then press **OK**.

Use one-touch play

- 1 After you switch on EasyLink, press play on your device.
 - ↳ The TV automatically switches to the correct source.

Use one-touch standby

- 1 When you press **⏻** on the TV remote control, the TV and all HDMI-CEC compliant devices switch to standby mode.
 - ↳ The TV and all connected HDMI devices switch to standby.

Use a Kensington lock

There is a Kensington security slot at the back of the TV. Prevent theft by looping a Kensington lock between the slot and a permanent object, such as a heavy table.

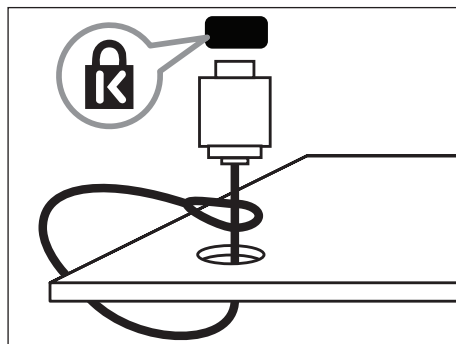

8 Product information

Product information is subject to change without notice. For detailed product information, go to www.philips.com/support.

Supported display resolutions

Computer formats

- Resolution - refresh rate:
 - 640 × 480 - 60Hz
 - 800 × 600 - 60Hz
 - 1024 × 768 - 60Hz
 - 1280 × 1024 - 60Hz
 - 1360 × 768 - 60Hz
 - 1920 × 1080 - R 60Hz — (Limit FULL HD, R: reduced blanking time)

Video formats

- Resolution - refresh rate:
 - 480i - 60Hz
 - 480p - 60Hz
 - 576i - 50Hz
 - 576p - 50Hz
 - 720p - 50Hz, 60Hz
 - 1080i - 50Hz, 60Hz
 - 1080p - 24Hz, 25Hz, 30Hz, 50Hz, 60Hz.

Multimedia

- Supported storage device: USB (Only FAT or FAT 32 USB storage devices are supported)
- Supported multimedia file formats:
 - Images: JPEG
 - Audio: MP3, WMA
 - Video: MPEG 2/MPEG 4, H.264, WMV

Tuner/Reception/Transmission

- Antenna input: 75ohm coaxial (IEC75)
- TV system: PAL,B/G
- Video playback: NTSC, SECAM, PAL
- Tuner Bands: UHF, VHF

Remote control

- Type: YKF293-001
- Batteries: 2 × AAA (LR03 type)

Power

- Mains power: 110-240V, 50Hz-60Hz
- Standby power: ≤0.5W
- Ambient temperature: 5 to 40 degrees Celsius
- Power consumption
 - 42PFL6556/V7: 145W
 - 46PFL6556/V7: 130W
 - 55PFL6556/V7: 190W

Supported TV mounts

To mount the TV, purchase a Philips TV mount or a compatible TV mount. To prevent damage to cables and connectors, leave a clearance of at least 2.2 inches or 5.5cm from the back of the TV.



Warning

- Follow all instructions provided with the TV mount. PE Electronics Ltd bears no responsibility for improper TV mounting that results in accident, injury or damage.

TV screen size (inches)	Required pitch (mm)	Required mounting bolts
42	400 × 400	4 × M6 (Suggested length 18mm)
46	400 × 400	4 × M6 (Suggested length 18mm)
55	400 × 400	4 × M6 (Suggested length 18mm)

55PFL6556/V7

- Without TV stand
- Dimension(WxHxD): 1287 × 774 × 40.4 (mm)/49.9 (Speaker) (mm)
- Weight: 21.34 kg
- With TV stand
- Dimension(WxHxD): 1287 × 827.3 × 290 (mm)
- Weight: 26.16 kg

Product specification

Design and specifications are subject to change without notice.

42PFL6556/V7

- Without TV stand
- Dimension(WxHxD): 994.11 × 611.1 × 39.9(mm)/49.9(Speaker) (mm)
- Weight: 12.47 kg
- With TV stand
- Dimension(WxHxD):994.11 × 661.8 × 239.57 (mm)
- Weight 15.16 kg

46PFL6556/V7

- Without TV stand
- Dimension(WxHxD): 1081.41 × 659.57 × 39.9 (mm)/49.9 (Speaker) (mm)
- Weight: 14.66 kg
- With TV stand
- Dimension(WxHxD): 1081.41 × 710.4 × 239.57 (mm)
- Weight: 17.36 kg

9 Troubleshooting

This section describes commonly encountered issues and accompanying solutions.

General TV issues

The TV does not switch on:

- Disconnect the power cable from the power outlet. Wait for one minute then reconnect it.
- Check that the power cable is securely connected.

The remote control is not working properly:

- Check that the remote control batteries are correctly inserted according to the +/- orientation.
- Replace the remote control batteries if they are flat or weak.
- Clean the remote control and TV sensor lens.

The standby light on the TV blinks red:

- Disconnect the power cable from the power outlet. Wait until the TV cools down before reconnecting the power cable. If the blinking reoccurs, contact Philips Consumer Care.

You forgot the code to unlock the TV lock feature

- Enter '8888'.

When turning the TV on/off/to standby, you hear a creaking sound from the TV chassis:

- No action is required. The creaking sound is normal expansion and contraction of the TV as it cools down and warms up. This does not impact performance.

Cannot remove 'e-sticker' banner displayed on the TV.

- To remove the logos and images, set the location of your TV to home.

1. Press **Home**.
2. Select **[Setup] > [TV settings] > [Preferences] > [Location]**.
3. Select **[Home]** and press **OK**.

TV channel issues

Previously installed channels do not appear in the channel list:

- Check that the correct channel list is selected.

Picture issues

The TV is on, but there is no picture:

- Check that the antenna is properly connected to the TV.
- Check that the correct device is selected as the TV source.

There is sound but no picture:

- Check that the picture settings are correctly set.

There is poor TV reception from an antenna connection:

- Check that the antenna is properly connected to the TV.
- Loudspeakers, unearthed audio devices, neon lights, high buildings and other large objects can influence reception quality. If possible, try to improve the reception quality by changing the antenna direction or moving devices away from the TV.
- If reception on only one channel is poor, fine tune this channel.

There is poor picture quality from connected devices:

- Check that the devices are connected properly.
- Check that the picture settings are correctly set.

The TV did not save your picture settings:

- Check that the TV location is set to the home setting. This mode offers you the flexibility to change and save settings.

The picture does not fit the screen; it is too big or too small:

- Try using a different picture format.

The picture position is incorrect:

- Picture signals from some devices may not fit the screen correctly. Check the signal output of the device.

Sound issues

There is a picture but sound quality is poor:

 **Note**

- If no audio signal is detected, the TV automatically switches the audio output off — this does not indicate malfunction.

- Check that all cables are properly connected.
- Check that the volume is not set to 0.
- Check that the sound is not muted.

There is a picture but the sound quality is poor:

- Check that the sound settings are correctly set.

There is a picture but sound comes from one speaker only:

- Verify that sound balance is set to the centre.

HDMI connection issues

There are problems with HDMI devices:

- Note that HDCP (High-bandwidth Digital Content Protection) support can delay the time taken for a TV to display content from a HDMI device.
- If the TV does not recognise the HDMI device and no picture is displayed, try switching the source from one device to another and back again.
- If there are intermittent sound disruptions, check that output settings from the HDMI device are correct.
- If you use an HDMI-to-DVI adapter or HDMI-to-DVI cable, check that an additional audio cable is connected to **AUDIO IN** (mini-jack only).

Computer connection issues

The computer display on the TV is not stable:

- Check that your PC uses the supported resolution and refresh rate.
- Set the TV picture format to unscaled.

Contact us

If you cannot resolve your problem, refer to the FAQs for this product at www.philips.com/support. If the problem remains unresolved, contact Philips Consumer Care in your country as listed in the Addendum.

 **Warning**

- Do not attempt to repair the product yourself. This may cause severe injury, irreparable damage to your product or void your warranty.

 **Note**

- Make a note of your TV model and serial number before you contact Philips. These numbers are printed on the back of the TV and on the packaging.

Consumer Guidelines

1. Kindly ensure that the dealer fills up Warranty card correctly.
 2. To avail the Warranty please register your product with the Philips-
 - Log on to www.philips.com
- OR
- Contact Philips Consumer Care Centre
3. In the unlikely event of a defect developing in the TV set contact the Philips Customer Care Centre for obtaining warranty service and inform of the defect observed in the set, the type no. and serial no. of the set.
 4. On your lodging a complaint, a trained technician will call on you promptly. In the event of the technician deciding that set requires attention at the service station; the technician would arrange to get the set picked up to be delivered to the service station for further attention. "Homecalls" by the technician would however be restricted within the municipal limits of the city/town in which the set has been registered.

Type no. _____ Serial No. _____ Date of Purchase _____

Purchased By: Name _____

Address: _____

_____ Tel.No. _____

Sold by: Name _____

Address: _____

_____ Tel.No. _____

<p>PHILIPS</p> <p>Model no.: 42PFL6556/V7 46PFL6556/V7 55PFL6556/V7</p> <p>Serial no.:</p> <p></p> <p>MADE IN PRC</p>

Sold by (User rubber stamp)

Contact Customer Service Executive at:
1860 180 1111 (Standard Call Rates Apply)
1800 102 2929 (Toll Free No.)

Regd Office: PE Electronics Ltd, Auto Cars Compound, Adalat Road, Aurangabad, 431005.

WARRANTY

This TV receiver is covered under warranty against any defect arising out of faulty or defective material or workmanship for a period of 12 months from the date of purchase.

Should a defect develop in this set during the period of warranty, PE Electronics Limited undertakes to get the set repaired free of charge either

from whom the set has been purchased or through an Authorised Service Center for warranty service. However, if the Purchaser has to shift his residence to another town on account of transfer or other reasons, the warranty benefit will be available at the Authorized Service Center of that town.

The warranty is not valid in case of any of the following events:

- The TV set is not used according to instructions given in the 'Direction for use' / 'User Manual'
- Defects are caused by improper or reckless use.
- Any repair work carried out by persons other than a Philips dealer or Authorised Service Center.
- Any modification or alteration of any nature made in the electrical circuitry of the set.
- This Warranty Card is not completed and signed immediately on delivery of the set by the Philips Dealer.
- Fading effects and/or Ghosts (Multiple Image) in picture, if any, arising due to location / signal reception.
- Defects due to causes beyond control like lightning, abnormal voltage, Acts of God or while in transit to purchaser's residence.

(Refer Consumer Guidelines for further details)

PHILIPS

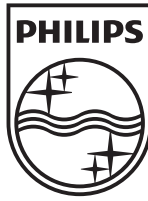

Be responsible
Respect copyrights

Specifications are subject to change without notice.

“PHILIPS and the PHILIPS Shield Emblem are registered trademarks of Koninklijke Philips Electronics N.V. and are used under license from Koninklijke Philips Electronics N.V.”

www.philips.com



X41G42MV813 6A