

# PHILIPS

---

# ROKU TV

## User manual

Register your product and get support at  
[www.philips.com/support](http://www.philips.com/support)

Call us:

**1-833-978-3323**

To obtain assistance, contact Philips customer care center;  
In the U.S.A., Canada, Puerto Rico, or the U.S. Virgin Islands

## Know these **safety** symbols



The caution marking is located on the rear or bottom of the cabinet.



The lightning flash with arrowhead symbol, within an equilateral triangle, is intended to alert the user to the presence of uninsulated "dangerous voltage" within the apparatus's enclosure that may be of sufficient magnitude to constitute a risk of electric shock to persons.



The exclamation point within an equilateral triangle is intended to alert the user to the presence of important operating and maintenance (servicing) instructions in the literature accompanying the apparatus.

**WARNING:** To reduce the risk of fire or electric shock, do not expose this apparatus to rain or moisture. Apparatus shall not be exposed to dripping or splashing and no objects filled with liquids, such as vases, shall be placed on the apparatus.

**CAUTION:** To prevent electric shock, match wide blade of plug to wide slot, fully insert.

**PHILIPS**

For fastest support visit us online for chat and self service solutions at [www.philips.com/support](http://www.philips.com/support)

## CHILD SAFETY:

### PROPER TELEVISION PLACEMENT MATTERS THE CONSUMER ELECTRONICS INDUSTRY CARES

- Manufacturers, retailers and the rest of the consumer technology industry are committed to making home entertainment safe and enjoyable.
- As you enjoy your television, please note that all televisions - new and old- must be supported on proper stands or installed according to the manufacturer's recommendations. Televisions that are inappropriately situated on dressers, bookcases, shelves, desks, speakers, chests, carts, etc., may fall over, resulting in injury.

### TUNE IN TO SAFETY

- **ALWAYS** follow the manufacturer's recommendations for the safe installation of your television.
- **ALWAYS** read and follow all instructions for proper use of your television.
- **NEVER** allow children to climb on or play on the television or the furniture on which the television is placed.
- **NEVER** place the television on furniture that can easily be used as steps, such as a chest of drawers.
- **ALWAYS** install the television where it cannot be pushed, pulled over or knocked down.
- **ALWAYS** route cords and cables connected to the television so that they cannot be tripped over, pulled or grabbed.

### WALL OR CEILING MOUNT YOUR TELEVISION

- **ALWAYS** contact your retailer about professional installation if you have any doubts about your ability to safely mount your television.
- **ALWAYS** use a mount that has been recommended by the television manufacturer and has a safety certification by a Nationally Recognized Testing Laboratory (NRTL).
- **ALWAYS** follow all instructions supplied by the television and mount manufacturers.
- **ALWAYS** make sure that the wall or ceiling where you are mounting the television is appropriate. Some mounts are not designed to be mounted to walls and ceilings with steel studs or cinder block construction. If you are unsure, contact a professional installer.
- Televisions can be heavy. A minimum of two people is required for a wall or ceiling mount installation.

### MOVING AN OLDER TELEVISION TO A NEW PLACE IN YOUR HOME

- Many new television buyers move their older CRT televisions into a secondary room after the purchase of a flat-panel television. Special care should be made in the placement of older CRT televisions.
- **ALWAYS** place your older CRT television on furniture that is sturdy and appropriate for its size and weight.
- **NEVER** place your older CRT television on a dresser where children may be tempted to use the drawers to climb.
- **ALWAYS** make sure your older CRT television does not hang over the edge of your furniture.

# Important safety instructions

1. Read these instructions.
2. Keep these instructions.
3. Heed all warnings.
4. Follow all instructions.
5. Do not use this apparatus near water.
6. Clean only with dry cloth.
7. Do not block any ventilation openings. Install in accordance with the manufacturer's instructions.
8. Do not install near any heat sources such as radiators, heat registers, stoves, or other apparatus (including amplifiers) that produce heat.
9. Do not defeat the safety purpose of the polarized or grounding-type plug. A polarized plug has two blades with one wider than the other. A grounding type plug has two blades and a third grounding prong. The wide blade or the third prong are provided for your safety. If the provided plug does not fit into your outlet, consult an electrician for replacement of the obsolete outlet.
10. Protect the power cord from being walked on or pinched particularly at plugs, convenience receptacles, and the point where they exit from the apparatus.
11. Only use attachments/accessories specified by the manufacturer.
12. Use only with the cart, stand, tripod, bracket, or table specified by the manufacturer, or sold with the apparatus. When a cart is used, use caution when moving the cart/apparatus combination to avoid injury from tip-over.



13. Unplug this apparatus during lightning storms or when unused for long periods of time.
14. Refer all servicing to qualified service personnel. Servicing is required when the apparatus has been damaged in any way, such as power-supply cord or plug is damaged, liquid has been spilled or objects have fallen into the apparatus, the apparatus has been exposed to rain or moisture, does not operate normally, or has been dropped.

## Note to the CATV system installer:

This reminder is provided to call the CATV system installer's attention to Article 820-40 of the NEC that provides guidelines for proper grounding and, in particular, specifies that the cable ground shall be connected to the grounding system of the building, as close to the point of cable entry as practical.

## Example of antenna grounding as per NEC - National Electric Code

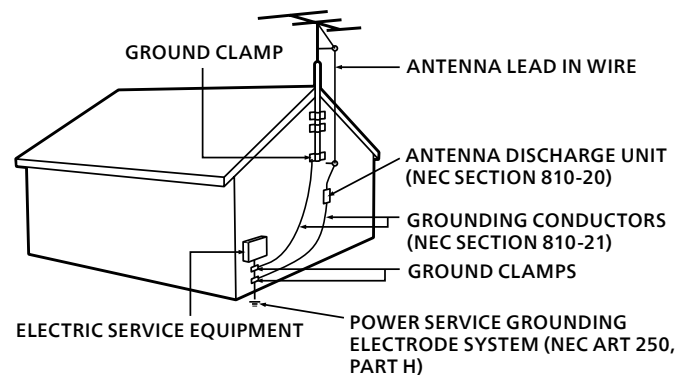

### Wall mount bracket kit

	Brand	Model #	Screw dimension
70"	SANUS	VLT6-B1	M6 x 1.378" (35 mm)
55"			M4 x 1.378" (35 mm)
43"			
40"			

- Your TV meets the VESA standard for wall mounting. Consult with your local dealer for a wall mount bracket which is compatible with your TV model.
- The recommended wall mount bracket kit (sold separately) allows the mounting of the TV on the wall.
- For detailed information on installing the wall mount, refer to the wall mount Instruction book.
- Funai Corporation is not responsible for any damage to the product or injury to yourself or others if you elect to install the TV wall mount bracket or mount the TV onto the bracket on your own.
- The wall mount bracket must be installed by experts.

### Funai Corporation is not liable for these types of accidents or injuries noted below.

- Install the wall mount bracket on a sturdy vertical wall.
- If installed onto a ceiling or slanted wall, the TV and wall mount bracket may fall which could result in a severe injury.
- Do not use screws that are longer or shorter than their specified length. If screws too long are used this may cause mechanical or electrical damage inside the TV set. If screws too short are used this may cause the TV set to fall.
- Do not fasten the screws by excessive force. This may damage the product or cause the product to fall, leading to an injury.
- For safety reasons use 2 people to mount the TV onto a wall mounting bracket.
- Do not mount the TV onto the wall mounting bracket while your TV is plugged in or turned on. It may result in an electrical shock injury.

### When installing the unit on the wall, allow this much space.

Top : 11.8" (30 cm)  
 Left and right side : 5.9" (15 cm)  
 Bottom : 3.9" (10 cm)

# Notice

Trademarks are the property of Koninklijke Philips N.V. or their respective owners.

Funai Corporation reserves the right to change products at any time without being obliged to adjust earlier supplies accordingly.

The material in this Owner's manual is believed adequate for the intended use of the system. If the product or its individual modules or procedures are used for purposes other than those specified herein, confirmation of their validity and suitability must be obtained. Funai Corporation warrants that the material itself does not infringe any United States patents. No further warranty is expressed or implied.

Funai Corporation cannot be held responsible neither for any errors in the content of this document nor for any problems as a result of the content in this document. Errors reported to Funai Corporation will be adapted and published on the Funai Corporation support website as soon as possible.

## Pixel characteristics

This LCD product has a high number of color pixels. Although it has effective pixels of 99.999% or more, black dots or bright points of light (red, green or blue) may appear constantly on the screen. This is a structural property of the display (within common industry standards) and is not a malfunction.

## Warranty

No components are user serviceable. Do not open or remove covers to the inside of the product. Repairs may only be done by service centers and official repair shops. Failure to do so shall void any warranty, stated or implied.

Any operation expressly prohibited in this manual, any adjustments or assembly procedures not recommended or authorized in this manual shall void the warranty.

## Federal communications commission notice

**This equipment has been tested and found to comply with the limits for a Class B digital device, pursuant to part 15 of the FCC Rules. These limits are designed to provide reasonable protection against harmful interference in a residential installation. This equipment generates, uses and can radiate radio frequency energy and, if not installed and used in accordance with the instructions, may cause harmful interference to radio communications. However, there is no guarantee that interference will not occur in a particular installation. If this equipment does cause harmful interference to radio or television reception, which can be determined by turning the equipment off and on, the user is encouraged to try to correct the interference by one or more of the following measures:**

- Reorient or relocate the receiving antenna.
- Increase the separation between the equipment and the receiver.
- Connect the equipment into an outlet on a circuit different from that to which the receiver is connected.
- Consult the dealer or an experienced radio or television technician for help.

## Modifications

This apparatus may generate or use radio frequency energy. Changes or modifications to this apparatus may cause harmful interference.

Any modifications to the apparatus must be approved by Funai Corporation.

The user could lose the authority to operate this apparatus if an unauthorized change or modification is made.

## Cables

Connections to this device must be made with shielded cables with metallic RFI/EMI connector hoods to maintain compliance with FCC Rules and regulations.

## Canadian notice

**CAN ICES-3 (B)/NMB-3 (B)  
Analog and digital television receiving apparatus, Canada BETS-7/  
NTMR-7.**

**The following FCC/IC RSS applies to the wireless LAN adapter included in this product.**

**FCC caution: Any changes or modifications not expressly approved by the party responsible for compliance could void the user's authority to operate this equipment.**

This transmitter must not be co-located or operated in conjunction with any other antenna or transmitter.

### FCC/IC RF Exposure Compliance

This equipment complies with FCC/IC radiation exposure limits set forth for an uncontrolled environment and meets the FCC radio frequency (RF) Exposure Guidelines and RSS-102 of the IC radio frequency (RF) Exposure rules.

This equipment should be installed and operated keeping the radiator at least 20cm or more away from your body.

This device complies with Part 15 of FCC Rules and Industry Canada licence-exempt RSS standard(s). Operation is subject to the following two conditions: (1) this device may not cause interference, and (2) this device must accept any interference, including interference that may cause undesired operation of this device.

5150-5250 MHz band is restricted to indoor operations only.

High-power radars are allocated as primary users (i.e. priority users) of the bands 5250-5350 MHz and 5650-5850 MHz and that these radars could cause interference and/or damage to LE-LAN devices.

### Compliance with FCC requirement 15.407(c) and IC requirement RSS-210 A9.4.4

Data transmission is always initiated by software, which is the passed down through the MAC, through the digital and analog baseband, and finally to the RF chip. Several special packets are initiated by the MAC. These are the only ways the digital baseband portion will turn on the RF transmitter, which it then turns off at the end of the packet. Therefore, the transmitter will be on only while one of the aforementioned packets is being transmitted. In other words, this device automatically discontinues transmission in case of either absence of information to transmit or operational failure.

## Positioning the TV

- Large screen TVs are heavy. 2 people are required to carry and handle a large screen TV.
- Make sure to hold the upper and bottom frames of the unit firmly as illustrated.
- Install the unit in a horizontal and stable position.
- Do not install the unit in direct sunlight or in a place subject to dust or strong vibration.
- Depending on the environment, the temperature of this unit may increase slightly. This is not a malfunction.
- When installing this unit in a temperate environment, avoid a place with rapid temperature changes.
  - Operating temperature: 41°F (5°C) to 104°F (40°C)
- This unit should not be used in a tropical environment as it has not been evaluated under such conditions.
- No objects should be placed directly on or under this unit, especially lighted candles or other flaming objects.
- Depending on your external devices, noise or disturbance of the picture and/or sound may be generated if the unit is placed too close to them. In this case, please ensure enough space between the external devices and the unit.
- Do not insert the AC power cord into the power socket outlet before all the connections are made.
- Ensure that you always have easy access to the AC power cord and outlet to disconnect the TV from the AC outlet.
- Before you move the TV, disconnect attached cables to prevent damage to connectors, especially the TV tuner.
- Be sure to unplug the AC power plug from the AC outlet before moving or carrying the unit.
- When moving the TV and then setting it down, please be careful not to pinch the AC power cord under the unit.
- Do not place this unit in an area where it may be exposed to water, oil or grease such as: near a bathtub, basin, kitchen sink, washing tub, swimming pool, kitchen exhaust fan, etc., or in a damp basement.

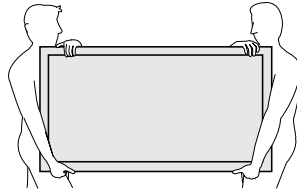

Press  to turn the unit on and go into standby mode. To completely turn off the unit, you must unplug the AC power plug from the AC power outlet.

Disconnect the AC power plug to shut the unit off when trouble is found or not in use. The AC plug shall remain readily available.

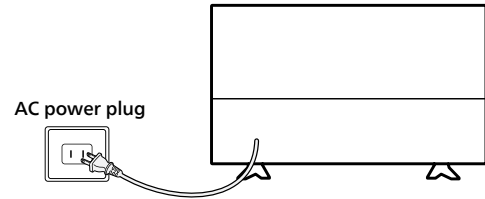

Never use a gas duster on this TV.

The gas trapped inside of this unit may cause ignition and explosion.

## Environmental care

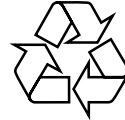

The packaging of this product is intended to be recycled.

Contact your local authorities for information about how to recycle the packaging.

For product recycling information, please visit - [www.recycle.philips.com](http://www.recycle.philips.com)

## End of life directives

Philips pays a lot of attention to produce environmental-friendly products in green focal areas. Your new TV contains materials which can be recycled and reused. At the end of its life, specialized companies can dismantle the discarded TV to concentrate the reusable materials and to minimize the amount of materials to be disposed of. Please ensure you dispose of your old TV according to local regulations.

## Batteries usage

**CAUTION** : Danger of explosion if battery is incorrectly replaced. Replace only with the same or equivalent type.

**WARNING** : Batteries (battery pack or battery installed) should not be exposed to excessive heat such as sunshine, fire or the like.

- Do not mix old and new batteries.
- Do not mix alkaline, standard (carbon-zinc) or rechargeable (ni-cad, nimh, Li-ion, etc.) batteries.

## Disposal of used batteries

**The batteries included do not contain the heavy metals mercury and cadmium, however in certain localities, disposing batteries with household waste is not permitted. Please ensure you dispose of batteries according to local regulations.**

## Preparing to move/ship the unit

Please pack the unit properly by following the diagram on the carton (as noted below).

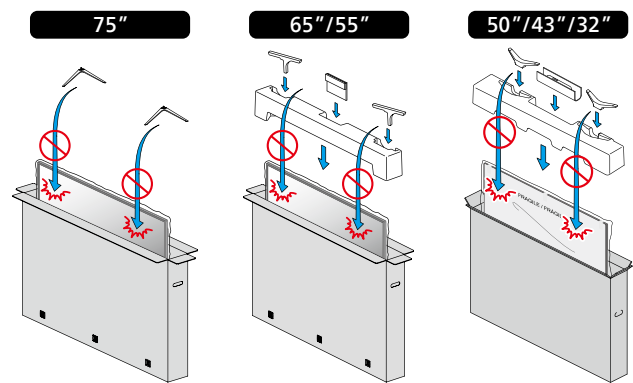

- To avoid damage to the screen, do not pack the stand on the same side as the TV screen, refer to the illustration above.

## Regulatory notices

**WARNING** : To prevent injury, this apparatus must be securely attached to the furniture/wall in accordance with the instructions. Tipping, shaking or rocking the unit may cause injury/death.

**WARNING** : Never place a TV in an unstable location. A TV may fall, causing serious personal injury or death. Many injuries, particularly to children, can be avoided by taking simple precautions such as:

- Using cabinets or stands recommended by the manufacturer of the TV.
- Only using furniture that can safely support the TV.
- Ensuring the TV is not overhanging the edge of the supporting furniture.
- Not placing the TV on tall furniture (for example, cupboards or bookcases) without anchoring both the furniture and the TV to a suitable support.
- Not placing the TV on cloth or other materials that may be located between the TV and supporting furniture.
- Educating the children about the dangers of climbing on furniture to reach the TV or its controls.

If your existing TV is being retained and relocated, the same considerations as above should be applied.

Do not place the unit on the furniture that is capable of being tilted by a child and an adult leaning, pulling, standing or climbing on it. A falling unit can cause serious injury or even death.

In order to avoid interruption of ventilation, this unit should not be placed in built-in equipment such as a book cabinet, rack, etc., and the vents of this unit should not be covered with anything such as a tablecloth, curtain, newspaper, etc. Make sure that there is enough ventilation space (4"/10 cm or more) around this unit.

## Copyright

All other registered and unregistered trademarks are the property of their respective owners.



The terms HDMI and HDMI High-Definition Multimedia Interface, and the HDMI Logo are trademarks or registered trademarks of HDMI Licensing Administrator, Inc. in the United States and other countries.



Manufactured under license from Dolby Laboratories. Dolby, Dolby Audio, and the double-D symbol are trademarks of Dolby Laboratories Licensing Corporation.

Portions of this software are copyright © The FreeType Project ([www.freetype.org](http://www.freetype.org)).

The American Academy of Pediatrics discourages television viewing for children younger than two years of age.

Some apps are not pre-installed, internet connection is required for download.

Some features may require an always-on broadband internet connection, firmware update and/or a minimum bandwidth. Internet services vary by location.

Funai Corporation Inc. does not warrant access to the portal or to any of the services, content, software and advertising. Funai Corporation Inc. may, in its sole discretion, add or remove access to any specific services, content, software and advertising at any time. Although Funai Corporation Inc.

will strive to provide a good selection of services, content or software, Funai Corporation Inc. does not warrant continued access to any specific services, and content or software.

Funai Corporation Inc. does not warrant Wireless Screencasting compatibility with all source devices such as smartphones, tablets, laptops, etc. due to large variability in hardware, firmware, drivers, software and implementation of wireless casting applications on these source devices. Although Funai Corporation Inc. will strive to enhance compatibility and performance across a range of source devices, Funai Corporation Inc. does not warrant compatibility with specific source devices.

## Channel Specification

Channel coverage	Antenna DTV (ATSC)	VHF: 2-13 UHF: 14-69
	Antenna Analog (NTSC)	VHF: 2-13 UHF: 14-69
	Cable DTV (QAM)	2-135
	Cable Analog (NTSC)	2-135
Tuning system	Channel frequency synthesized tuning system	

## Copyright

© 2022 Roku, Inc. All rights reserved. ROKU, the ROKU Logo, and “NOW THIS IS TV” are trademarks and/or registered trademarks of Roku, Inc. Material in this User Manual is the property of Roku, Inc., and is protected under US and International copyright and/or other intellectual property laws. Reproduction or transmission of the materials, in whole or in part, in any manner, electronic, print, or otherwise, without the prior written consent of Roku, Inc., is a violation of Roku, Inc.’s, rights under the aforementioned laws.

No part of this publication may be stored, reproduced, transmitted, or distributed, in whole or in part, in any manner, electronic or otherwise, whether or not for a charge or other or no consideration, without the prior written permission of Roku, Inc.

Requests for permission to store, reproduce, transmit or distribute materials shall be made to the following address:

Roku, Inc.  
1155 Coleman Avenue,  
San Jose, CA 95110

Product name: Roku TV™

Document name: Roku TV™ User Guide

Document revision: 11.0 – United States and Canada, English

Publication date: 1 April, 2022

# Contents

Welcome .....	1
The new standard in Smart TVs .....	1
Get the most out of your new TV .....	2
Connections and setup .....	8
Connecting an antenna, cable, or satellite box .....	8
Connecting external equipment with a composite AV video cable .....	9
Connecting external equipment with an HDMI® cable .....	9
Connecting headphones or analog soundbar .....	10
Connecting headphones to a Roku Voice Remote Pro .....	10
Connecting an AV receiver or digital soundbar .....	11
Preparing for Internet connectivity .....	11
AC power .....	12
Roku remote batteries .....	12
Roku TV remote .....	13
Panel buttons .....	17
Single button .....	17
Three buttons .....	18
Game-pad style joystick .....	18
Four buttons .....	18
Five buttons (with mute) .....	19
Five buttons (without mute) .....	19
Seven buttons .....	19
Guided Setup .....	21
Starting Guided Setup .....	21
Guided Setup .....	22
Network connection .....	24
Activation .....	29
Connect your devices .....	30
The Home screen .....	33
Personalize your Home screen .....	34
Benefits of connecting .....	36
Connecting brings out your TV's full potential! .....	36
Take advantage of awesome features .....	37



What is streaming?.....	38
What if I didn't connect my TV?.....	40
<b>Setting up live TV .....</b>	<b>41</b>
How do I set up the TV tuner?.....	42
<b>Using your TV .....</b>	<b>46</b>
Status indicator .....	46
Standby mode energy savings.....	47
Getting help .....	47
Opting in to Smart TV experience (U.S. only).....	48
Disable Smart TV experience.....	48
Disable Auto Notifications .....	49
Watching live TV channels.....	49
Changing channels.....	49
Using the Live TV Channel Guide (U.S. only).....	50
Navigating the Live TV Channel Guide in connected mode (U.S. only) .....	52
Changing channel options in connected mode (U.S. only) .....	52
Viewing program information .....	53
Adjusting settings while watching a program .....	55
Pausing live TV .....	55
Requirements .....	55
Enabling Live TV Pause.....	56
Using Live TV Pause .....	56
Notes about Live TV Pause.....	58
More Ways to Watch (U.S. only).....	58
Using More Ways to Watch .....	59
Getting the most from More Ways to Watch.....	61
Automatic network recommendation .....	61
Switching TV inputs.....	62
Auto-detecting devices.....	62
Adjusting audio/video settings.....	62
Setting preferred audio language for streaming channels .....	63
Automatic game console configuration .....	63
Using Roku Voice commands.....	64
Using Roku Voice remotes (select models only).....	65
Playing content from USB storage devices.....	67
Auto player launch.....	68
Playing content from local network media servers.....	68
Setting up a payment method .....	69
Using your TV in a hotel or dorm room.....	69
About using your TV on a restricted public network.....	70
Getting your Roku TV on line on a restricted public network .....	70

Using Apple AirPlay and the Apple Home app .....	73
Apple AirPlay.....	73
Other AirPlay things to try .....	73
Apple Home app .....	73
Some Apple HomeKit things to try .....	74
Adjusting TV settings .....	75
Main Settings menu.....	75
TV settings menu .....	76
Sleep timer.....	77
Picture settings.....	77
Fine tune picture menu options.....	80
Variable refresh rate (VRR).....	81
Expert Picture Settings (4K models only).....	81
Sound settings.....	82
Roku premium audio devices.....	82
Volume mode (select models only).....	84
Sound settings - Dolby® Audio Processing (select models only).....	85
Sound settings - DTS® TruSurround / DTS® Studio Sound (select models only).....	86
Sound settings - Sonic Emotion™ Premium (select models only).....	87
Sonic Emotion™ settings.....	89
Manage channels (U.S., connected mode).....	90
Favorite channels (U.S., connected mode).....	90
Edit live TV channel lineup (U.S., connected mode).....	91
Hide all streaming TV channels (U.S., connected mode).....	92
Manage channels (Canada/non-connected mode).....	93
Favorite channels (Canada/non-connected mode).....	93
Surf only favorite channels (Canada/non-connected mode).....	93
Edit live TV channel lineup (Canada/non-connected mode).....	94
Accessibility & captions .....	95
Accessibility & captions menu settings.....	96
Video description through Secondary Audio Program (SAP).....	97
Picture off.....	98
Featured Free (U.S. only) .....	99
My Feed.....	100
Movies Coming Soon (U.S. only).....	100
Movies, TV programs, and people.....	100
Searching for something to watch.....	102
How do I search?.....	102
Keyboard search using the remote.....	103
Voice Search from a Roku Voice remote.....	103

Searching from the Roku mobile app.....	104
Searching with Google Assistant.....	104
Searching with Amazon Alexa.....	105
Direct-to-playback search results.....	105
Searching for free content.....	106
I found a program. Now what?.....	106
Follow on Roku.....	107
Recent Searches.....	107
Roku Zones (U.S. only).....	108
Using the Roku Channel Store.....	109
Automatic Account Link.....	110
Customizing your TV.....	111
Add TV inputs.....	111
Add streaming channels.....	111
Rename inputs.....	112
Remove unwanted tiles.....	113
Rearrange tiles.....	114
Change the look and feel with themes.....	115
Hide streaming TV channels (U.S. only).....	115
Change menu volume.....	116
Configure power settings.....	116
Power on settings.....	116
Auto power savings.....	117
Standby LED On/Off.....	117
Fast TV start.....	117
Configure accessibility.....	118
Captions mode.....	118
Captions preferred language.....	118
Captions style.....	119
Screen reader settings (U.S. only).....	120
Customize the Home screen.....	121
Parental controls.....	122
Creating a parental control PIN.....	122
Blocking broadcast TV programs.....	123
Enabling parental control of TV programs.....	123
Blocking based on US TV ratings.....	124
Blocking based on US movie ratings.....	125
Blocking based on Other ratings.....	125
Blocking based on Canadian English ratings.....	126
Blocking based on Canadian French ratings.....	127
Blocking unrated programs.....	128
What happens when a TV program is blocked?.....	129

Changing the parental control PIN .....	131
Resetting parental controls.....	131
<b>More settings .....</b>	<b>132</b>
Guest Mode .....	132
Network settings .....	134
ZIP Code or postal code.....	135
Time settings .....	135
Scan again for live TV channels.....	136
HDMI® mode (4K models only).....	137
Control by mobile apps.....	137
Changing privacy settings.....	138
Advertising.....	138
Microphone.....	139
Roku TV premium audio.....	141
Home theater configuration .....	142
Controlling audio output .....	142
Setting up a digital audio connection.....	143
Choosing an audio format .....	144
Turning off the TV screen while listening to music .....	145
Controlling other devices through CEC.....	145
Restart the TV.....	146
Reset the TV .....	147
Reset audio/picture settings.....	147
Factory reset everything .....	147
What if I can't access the Factory Reset option?.....	148
Network connection reset .....	148
Roku account PIN .....	149
Update the TV .....	150
Checking for updates on a connected TV.....	150
Getting updates on a non-connected TV .....	151
<b>Other devices.....</b>	<b>153</b>
Mirror your phone or tablet .....	153
Roku mobile app.....	154
Private Listening on the Roku mobile app.....	154
Universal remotes .....	155
<b>FAQ .....</b>	<b>156</b>



# Welcome

Congratulations on the purchase of your new Roku TV! Discover the joy of endless entertainment. After it's set up, you'll be able to access a world of streaming content channels that may include paid subscription channels and thousands of free channels.

**Important:** *Your TV receives automatic updates from time to time, enabling new content and features. This edition of the User Guide describes Roku TV version 11.0. To determine the current version of your Roku TV, go to **Settings > System > About** after you complete Guided Setup. Note also that certain features of the TV might change from time to time independently of Roku TV updates.*

## The new standard in Smart TVs

Welcome to TV like you've most likely never seen before—a home screen that you can personalize with your favorite devices and streaming channels. Choose from hundreds of thousands of streaming movies and TV episodes, plus music, sports, kids, family, international and much more. You should never run out of things to watch.

**Note:** *A paid subscription or other payments may be required for some channel content. Channel availability is subject to change and varies by country.*

# Get the most out of your new TV

Follow these steps to get the most out of your new TV.

- **Connect to the Internet**
  - It's easy, and it will unlock a world of entertainment. All you need is a network connection. There are hundreds of free streaming channels, paid subscription services, and convenient ways to rent or buy a favorite movie or program.
- **Pick your favorite streaming channels**
  - Find the entertainment you love. From the latest blockbuster movies to your favorite TV programs, with tons of live sports, a broad selection of music streaming channels, popular programming in a dozen international languages, 24x7 live news and so much more, your new Roku TV has your sweet spot. A paid subscription or other payments may be required for some channels.
- **Find live broadcast and streaming TV programs in the Live TV Channel Guide**
  - *Only in the United States*, use the Live TV Channel Guide to see not only what's on TV right now, but what will be on in the coming two weeks. And for many over-the-air programs, if you start watching the program after it is already in progress, or you see something you missed in the Live TV Channel Guide, you can use More Ways to Watch to find streaming channels where you can see the program from the beginning, find other episodes, or entire seasons of the program, if applicable.
- **Use Roku's Smart TV experience to discover More Ways to Watch**
  - *Only in the United States*, use this feature to find out how you can stream the program you are watching from the beginning, find more episodes of the program, discover similar programs and movies, and see the full description of the program.
- **Personalize your Home screen**
  - Put your favorite streaming channels and TV inputs front-and-center on the Home screen. No more flipping through inputs or wading through complicated menus. You can even customize the names of each input and move tiles around so your most-often used devices and streaming channels are only a click away.

- **Search for your favorite movie, TV program, actor, or director**
  - Once you're connected to the Internet, you can easily search across top streaming channels and live TV channels. Search by movie or TV program title, actor, or director—all from one place. Search by typing words or phrases using the on-screen keyboard or on your mobile device, or speak words or phrases in a conversational tone using Voice Search. Some channels and content require payment.
  - *Only in the United States*, receive a Roku Zone when you search by popular genres or subjects. A Roku Zone is a collection of relevant entertainment organized into browsable rows such as New Releases, Free, and Rent or Buy. On 4K TVs, include "4K" in your search to see 4K movies and programs in the 4K Movies & TV Zone.
- **Pause live TV**
  - Pause, resume, fast forward, and rewind TV programs by connecting your own USB drive to the TV and pause live TV for up to 90 minutes.  
**Note:** *Live TV Pause is available on digital TV programs received on the **ANT** input, and only when the TV is linked to a valid Roku account.*
- **Watch the Roku Tips & Tricks channel**
  - *Only in the United States*, tune in to the Roku Tips & Tricks channel to watch videos and learn more about your TV's features, new products, and popular support topics.
- **Control your TV with voice commands**
  - Use your Roku Voice remote (select models) or the free Roku mobile app to control your Roku TV. Use conversational voice commands to search for programs by title, actor, director, or genre. On selected streaming channels, you can search without leaving the current channel. Your search results appear in the lower portion of the screen. The current channel's results appear first followed by results from other channels.



Just tap **Voice**  on your remote to see helpful hints about how to use Roku Voice, and then explore these additional voice features:

- *Only in the United States*, see what's on TV in the Live TV Channel Guide. For example, say "Show Guide." Jump to a specific live or streaming channel. For example, say "Go to 7 point 3" to open Live TV on channel 7.3. Or say, "Go to Netflix" to open Netflix.
- Use voice commands to launch streaming channels, switch inputs, or change live TV channels.<sup>1</sup>
- Set sleep timers. For example, say "Turn the TV off in 30 minutes", or "Go to sleep at 11 p.m."
- Go directly to playing a program whenever your search command can be uniquely identified and the requested content is available at no additional cost to you.<sup>2</sup>
- *Only on 4K TVs*, say "Show me 4K movies" to see a list of 4K movies available across participating streaming channels.
- Use Roku Voice to make on-screen keyboard entries in a variety of on-screen keyboards. Keyboards that support voice entry have a microphone icon next to the input field. You can say letters, characters, and numbers for an easy way to enter the required information. The TV displays helpful hints at appropriate times to provide guidance.
- Use voice commands to turn the display off (for enjoying streaming music), turn closed captions on or off, and to replay the last few seconds of a movie or TV program.
- Control the Roku Media Player to play your personal music and show movies and photos. Say commands like, "Play classic rock on Roku Media Player," "Skip ahead 20 seconds," or "Play the next song."
- Open Voice Help from Settings menu or by pressing **VOICE**  and saying, "Help."

---

<sup>1</sup> Voice features support English and Spanish languages when the corresponding TV language is selected.

<sup>2</sup> Direct-to-playback commands work with selected streaming channels. Direct playback occurs only when there is a high confidence of match, the content is free or you are already subscribed, and the channel is already added to your Home screen.

- Ask Siri on your Apple device to control your Roku TV with just your voice<sup>1</sup>. Say things like “Hey Siri, play jazz on the living room TV” to play music from your iPhone, iPad, Apple Watch, HomePod Mini, or Mac on your Roku TV. Roku TVs also support Apple HomeKit<sup>1</sup>, which allows you to easily and securely control your Roku device while using the Home app or Siri. After installing your Roku TV, set it up with just a few simple steps within the Apple Home app. You can even create your own custom automations and scenes that include HomeKit-enabled accessories such as your Roku TV, to control your home setting.
- Use Google Home, Google Pixel phone, or the Google Home mobile app to control your Roku TV. You can search for movies and TV programs, launch most channels, control playback, adjust the volume, switch inputs, turn the TV on and off, and more. Control multiple Roku devices by including the location of the device in your commands. For example, say “Hey Google, turn off Roku in the bedroom.” For information on linking and controlling your Roku TV, see <https://support.roku.com/article/360009649613-how-do-i-control-my-roku-streaming-device-with-the-google-assistant->.
- Use Amazon Echo Dot, Echo Plus, Echo Show, or the Amazon Alexa mobile app to control your Roku TV. You can search for movies and TV programs, launch most channels, control playback, adjust the volume, switch inputs, turn the TV on and off, and more. Control multiple Roku devices by including the location of the device in your commands. For example, say “Hey Alexa, pause Roku in the living room.” For information on adding the Alexa Roku skills and controlling your Roku TV, see: <https://support.roku.com/article/360017961074-how-do-i-use-amazon-alexa-with-my-roku-streaming-device->.

---

<sup>1</sup> Apple AirPlay 2 and HomeKit are supported by Roku TVs except for models beginning with “6” (6XXXX) and “5” (5XXXX).

- **Use Apple AirPlay 2 with your iOS and MacOS devices**
  - Effortlessly share videos, photos, music, and more from Apple devices on Roku TVs<sup>1</sup>. Control AirPlay sessions with pause, rewind, and more using your iPhone, iPad, or Mac. Play music from your Apple devices on Roku TVs and other AirPlay 2 enabled speakers in your home at the same time in perfect sync. Plus, mirror the screen from your iPhone, iPad, or Mac to the big screen.
- **Send your personal media to the big screen**
  - Send personal photos, videos, and music from your compatible smartphone or tablet to the TV screen in just a few taps. Plus, with certain channels, you can send movies, programs, sport highlights, and more directly to your TV.
- **Watch for content with My Feed**
  - Use My Feed to get updates on movies, TV programs, and actors that you are following, and then watch for alerts each time one of your followed items becomes available or changes price.
- **Take charge with the Roku mobile app**
  - Control your TV from your compatible smartphone or tablet with the free mobile app for iOS<sup>®</sup> and Android<sup>™</sup> mobile devices<sup>2</sup>. Browse channels, view My Feed, listen to audio from live TV and streaming channels. Search more easily using your mobile device's keyboard and Voice Search.<sup>3</sup>
  - Mirror your compatible smartphone or tablet on your TV. Share videos, photos, web pages, and more from compatible devices.

---

<sup>1</sup> Apple AirPlay 2 and HomeKit are supported by Roku TVs except for models beginning with "6" (6XXXX) and "5" (5XXXX).

<sup>2</sup> IOS<sup>®</sup> is a trademark or registered trademark of Cisco in the U.S. and other countries and is used under license. Android<sup>™</sup> is a trademark of Google Inc.

<sup>3</sup> Voice features support English and Spanish languages when the corresponding TV language is selected.

- **Get the best streaming experience with automatic network recommendation**

- While you are watching a streaming channel, and during manual wireless network scans, your TV will recommend the optimal wireless network connection. You can choose to switch to the recommended network or continue with the current connection.

- **Connect your Roku TV to networks found in hotels and college dorms**

- Temporarily link your smartphone or tablet to your TV to agree to any terms, enter codes, or provide required information before you can get Internet access in locations that require these additional steps (also known as *restricted public networks*).

- **Note:** *Using your Roku TV on a restricted public network requires wireless availability and use of your network-connected smartphone, tablet, or computer to authenticate access to your account. You must use your Roku TV remote, and not the Roku mobile app, to initiate the connection process. Streaming content might be limited due to your geographic location or because of restrictions imposed by the network host.*

Go to [support.roku.com](https://support.roku.com) for device compatibility information.

Let's get started.

# Connections and setup

Refer to your TV's Quick Start Guide or other provided documentation for model-specific information about attaching the base or a wall mount and making connections to AC power and to your other audio/video devices.

## Connecting an antenna, cable, or satellite box

If you are using an antenna, CATV cable without a set-top box, or a cable or satellite box that has only an antenna output, connect a 75-ohm coaxial cable (not provided) from the source to the **ANT/CABLE** input on the TV.

**Tip:** *If you are using an antenna with a 300-ohm twin-lead cable, you need to use a 300-to-75-ohm adapter (not provided) to adapt the twin-lead cable to a connection that is compatible with the TV's antenna input.*

**Tip:** *If you receive your TV stations through a set top box from a cable or satellite TV provider, connect it to the TV using the best connection method available. From most to least desirable:*

- **HDMI® input** – Digital HD and SD video
- **AV input** – analog SD video
- **Antenna input** – analog SD video using NTSC

## Connecting external equipment with a composite AV video cable

If the best connection available on your device is AV or composite video output, connect it to the TV using a composite AV cable (not provided). Composite AV cables typically have three RCA-type plugs on each end, color coded as follows:

- **Yellow** – Video
- **Red** – Audio, right channel
- **White or black** – Audio, left channel

Connect each plug to the corresponding connector on the device and on the TV.

**Note:** *Select models have an AV Input that looks like a headphone jack. Use the breakout cable (included) to adapt this input to the three RCA-type plugs on your composite cable.*

## Connecting external equipment with an HDMI<sup>®</sup> cable

If possible, connect your devices using HDMI<sup>®</sup> cables (not provided). They help to provide the best video quality and also carry audio signals, so that only one cable is needed. For better picture quality, we recommend that you use cables designated as High Speed HDMI<sup>®</sup> Cables.

**Tip:** *You might need to configure the device to send its signal through its HDMI<sup>®</sup> connector.*

The connector labeled **HDMI (ARC)** has the additional ability to use the audio return channel to send digital audio to a receiver or soundbar, as explained in [Connecting an AV receiver or digital soundbar](#). *Only on select models:* The connector labeled **HDMI (eARC)** provides the same functionality as the **HDMI ARC** connector, plus the ability to pass through full-resolution sound formats such as Dolby Atmos and DTS:X from and to devices that support these formats, without additional processing by the TV. Additional details are provided in [Choosing an audio format](#).

## Connecting headphones or analog soundbar

You can connect headphones or an analog soundbar (not provided) to the TV's headphone jack.

**Tip:** *Inserting a plug in the headphone jack disables the sound from the TV's built-in speakers.*

**Warning:** *Loud noise can damage your hearing. When using headphones, use the lowest volume setting on your headphones that still lets you hear the sound.*

Select models also have an audio line out connection that is not affected by TV volume or mute settings and does not disable the TV speakers. Use this connection when you want to use your amplifier or soundbar to control the TV volume. To turn off the TV's built-in speakers, from the Home screen menu, navigate to **Settings > Audio > TV speakers** and change the setting.

## Connecting headphones to a Roku Voice Remote Pro

Select Roku TVs come with the Roku Enhanced Voice Remote or Roku Voice Remote Pro. On these models, you can connect headphones to the jack on the left side of the remote.

**Tip:** *Inserting a plug in the remote's headphone jack disables the sound from the TV's built-in speakers or attached receiver or soundbar. The volume and mute controls on the right side of the remote adjust the volume level of the connected headphones.*

**Warning:** *Loud noise can damage your hearing. When using headphones, use the lowest volume setting on your headphones that still lets you hear the sound. You might notice that connecting headphones to your remote shortens the remote's battery life somewhat.*

## Connecting an AV receiver or digital soundbar

You can enjoy Dolby Audio™ multichannel sound from your TV if you connect a digital amplifier or soundbar (not provided) in any of the following ways:

- **Digital optical audio out (S/PDIF)** – Connect a TOSLINK optical cable (not provided) from the TV to the Optical input on your receiver or soundbar.
- **HDMI® ARC** – Connect an HDMI® cable (not provided) from the **HDMI (ARC)** connector to the HDMI® input on your receiver or soundbar. This connection uses the Audio Return Channel (ARC) feature of HDMI® to output sound from the TV to a compatible device. To use this feature, you must configure the TV to enable HDMI® ARC, as explained in [Setting up a digital audio connection](#).
- **HDMI® eARC** – *Select models only:* Connect an HDMI® cable (not provided) from the **HDMI (eARC)** connector to the HDMI (ARC) or HDMI (eARC) input on your receiver or soundbar. If your receiver or soundbar supports HDMI enhanced ARC (eARC), the TV can pass through full-resolution sound from programs containing enhanced audio. If your receiver or soundbar does not support eARC, use the TV's eARC port to make the connection to the device's ARC port. The eARC port is backward compatible with the ARC standard.

## Preparing for Internet connectivity

If you want to watch streaming content and take advantage of most of the cool features of your Roku TV, connect it to the Internet through a wireless modem/router or a wireless access point (not provided). The TV has a built-in wireless LAN adapter.

**Note:** *The TV supports only its internal wireless network adapter—it does not support the use of a USB network adapter.*

Select models have both wired and wireless network connectivity. To use the wired network connection, connect an RJ-45 Ethernet cable (not provided) from the jack on the back of your TV to your network router or switch. The wired connection automatically supports both 10 Base-T and 100 Base-T Ethernet.



## AC power

Plug your TV into a power outlet. You can tell that the TV has power because the status indicator lights up when the TV is off.

The topic [Status indicator](#) explains how the status indicator shows what is happening with the TV.

## Roku remote batteries

Open the back of your Roku remote and insert the included batteries, observing the proper orientation as indicated in the battery compartment. Reattach the back cover.

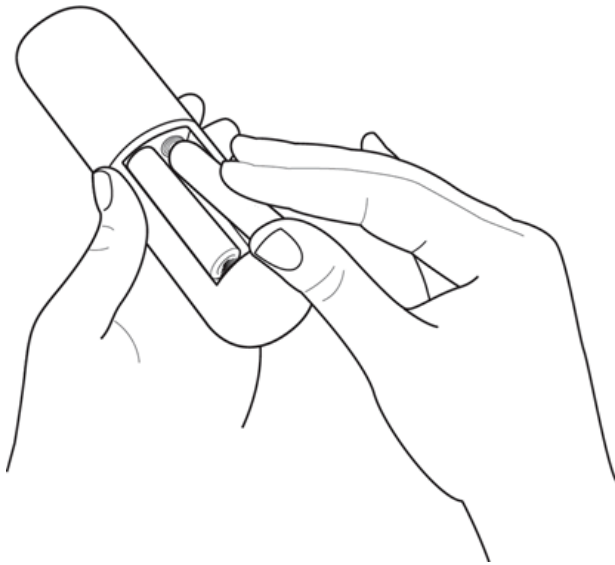



# Roku TV remote



Use the following information to identify the buttons on your Roku remote.

**Note:** Remote buttons and features vary somewhat by model. Your remote might not have all buttons or features listed.











- If your remote has a **VOICE**  just below the purple pad, you have a Roku Voice Remote.
- If your remote has a headphone jack on its left edge, you have a Roku Enhanced Voice Remote or Roku Voice Remote Pro.







Roku Voice remotes have additional capabilities as noted in the following table.

BUTTON	FUNCTION	DESCRIPTION
	POWER	Turns TV on and off.
	BACK	<ul style="list-style-type: none"><li>• <b>Menu:</b> Goes back to previous menu/screen.</li><li>• <b>Home screen tile:</b> Moves highlight back to the Home screen option.</li><li>• <b>Watching live TV or a TV input:</b> Returns to Home screen.</li><li>• <b>Playing streaming content:</b> Stops playing stream and returns to the previous menu or screen.</li><li>• <b>Browsing streaming content:</b> Goes to the previous level in the content tree.</li></ul>
	HOME	Immediately returns to the Home screen.

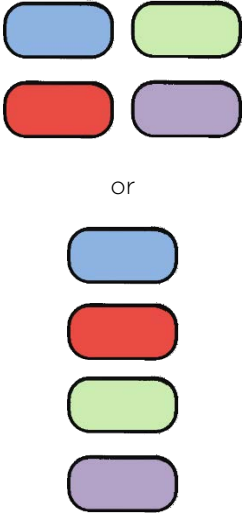
BUTTON	FUNCTION	DESCRIPTION
	<b>DIRECTIONAL PAD</b>	<ul style="list-style-type: none"> <li>Moves the highlight in the corresponding direction.</li> <li><b>OK</b> chooses the highlighted option.</li> </ul> <p>While watching TV:</p> <ul style="list-style-type: none"> <li><b>UP/DOWN</b> changes channel.</li> <li><b>LEFT</b> displays the Live TV Channel Guide (connected mode) or channel list (non-connected mode).</li> <li><b>LEFT/RIGHT TVs operating in non-connected mode:</b> while in the channel list switches between ALL CHANNELS and FAVORITE CHANNELS. <i>TVs with Live TV Pause enabled:</i> when the program is paused, moves backward/forward approximately 10 seconds in the program buffer.</li> <li>While in the channel list, <b>OK</b> selects the highlighted channel. While watching live TV: displays the program information banner.</li> </ul>
	<b>VOICE or SEARCH</b>	<p><i>Only on select models with Roku Voice remotes, hold and say the name of a movie, TV program, actor, director, or genre, including the special genres “free” and “4K.” Or, say a command to start streaming, change a channel, and more<sup>1</sup>.</i></p> <p>For more information, go to: <a href="https://go.roku.com/voicesearch">go.roku.com/voicesearch</a></p>
	<b>REPLAY</b>	<p><i>Select models.</i> Streaming programs that support this feature and TVs with Live TV Pause enabled, jumps back a few seconds with each press and resumes playing.</p> <p>If Live TV Pause is disabled, jumps to previous channel.</p> <p>When using an on-screen keyboard: Backspaces in the text you are entering.</p> <p>In the Live TV Channel Guide<sup>2</sup>: Returns to the current day and time.</p>

<sup>1</sup> Voice features support English and Spanish languages when the corresponding TV language is selected.  
<sup>2</sup> Live TV Channel Guide is available only in the United States.

BUTTON	FUNCTION	DESCRIPTION
	<p> <b>REWIND</b></p> <p> <b>PLAY/PAUSE</b></p> <p> <b>FAST FWD</b></p>	<p>Scan backward, pause, play, and scan forward in streaming content and live TV channels (if Live TV Pause is enabled).</p> <p>Press <b>REWIND</b>  or <b>FAST FWD</b>  one, two, or three times to control the speed of the operation.</p> <p><b>REWIND</b>  and <b>FAST FWD</b>  also jump backward and forward one screen at a time when viewing long lists, such as when you are browsing programs in the channel list or Live TV Channel Guide<sup>1</sup>.</p>
	<p><b>STAR</b></p>	<p>Displays additional options when available. On-screen hints let you know when this button is active.</p>
	<p><b>GAME MODE</b></p>	<p><i>Only on <b>HDMI</b> and <b>AV</b> inputs on select models.</i> Displays a banner showing whether Game mode is on or off, or “Not available at this time.” Subsequent presses toggle Game mode. When <b>On</b>, the TV performs less image processing and has less input lag, producing a better experience with action games.</p> <p><i>Select models.</i> Auto Low Latency Mode (ALLM) detects certain game consoles connected to an <b>HDMI</b> input and automatically switches to the best settings for action games. When ALLM is active, the manual Game mode setting is unavailable.</p> <p><i>Select models.</i> Variable refresh rate (VRR) allows a compatible game console or computer to control the refresh rate of the TV. The result is smoother image animation with a lower instance of stutter or tearing.</p>
	<p><b>SLEEP</b></p>	<p><i>Select models.</i> Displays a banner showing the remaining sleep time, if any, or “Sleep timer is off.” Subsequent presses cycle among the preset sleep time intervals. Once set, the sleep timer remains in effect unless you cancel it.</p>

BUTTON	FUNCTION	DESCRIPTION
	<p><b>FACTORY ASSIGNED CHANNEL SHORTCUT</b></p>	<p>Dedicated buttons show the logo of a preset streaming content provider. Dedicated content providers vary by model and region. Pressing a button:</p> <ul style="list-style-type: none"> <li>• Displays the streaming channel's main page if you have already added the channel to your Home screen.</li> <li>• Displays the streaming channel's sign-up page if you have not already added the channel.</li> </ul>
	<p> UP</p> <p> DOWN</p> <p> MUTE</p>	<p>Located on the right edge of the remote. Increases/decreases volume and mutes the TV sound.</p> <p><b>Note:</b> <i>If the TV is muted, pressing <b>VOLUME UP</b> unmutes. Pressing <b>VOLUME DOWN</b> does not unmute the sound.</i></p>
	<p> HEADPHONE</p>	<p>Select models with Roku Enhanced Voice Remote or Roku Voice Remote Pro. Connect headphones to the jack on the left edge of the remote to listen privately. Plugging in headphones mutes the TV speakers.</p>

# Panel buttons

Your TV has buttons on its side, bottom, or back panel that perform simple control functions. The TV panel buttons are not a substitute for the remote, as they do not give you access to all TV functions.

Depending on model, your TV model has one of several different panel button designs. Choose the one that applies to your TV from the following list:

- [Single button](#)
- [Three buttons](#)
- [Game-pad style joystick](#)
- [Four buttons](#)
- [Five buttons \(with mute\)](#)
- [Five buttons \(without mute\)](#)
- [Seven buttons](#)

## Single button

If your TV has this style of panel button, you can perform the following functions:

- **Turn TV on:** short press.
- **Display the Input List:** short press when TV is on.
- **Select the next input in the Input List:** short press while the TV is showing the Input List.
- **Dismiss the Input List without changing inputs:** no press.
- **Turn TV off:** long press.

Short press = less than two seconds

Long press = more than two seconds

No press = no press within two seconds

## Three buttons

If your TV has this style of panel buttons, you can perform the following functions:

- **Turn TV on:** middle button, short or long press.
- **Volume up:** right button when Input List is not active.
- **Volume down:** left button when Input List is not active.
- **Display Input List:** middle button, short press when TV is on.
- **Highlight next input in the Input List:** right button when Input List is active.
- **Highlight previous input in the Input List:** left button when Input List is active.
- **Select highlighted item in the Input List:** middle button, short press, or no press.
- **Turn TV off:** middle button, long press.

Short press = less than two seconds

Long press = more than two seconds

No press = no press within four seconds

## Game-pad style joystick

If your TV has this style of panel button, you can perform the following functions:



- **Press in:** Toggle between power ON and Standby.
- **Press up or down:** Increase/decrease the volume.
- **Press left or right:** Switch inputs. Each press moves the highlight up or down one item. Pausing for a few moments selects the highlighted item.

## Four buttons

If your TV has this style of panel buttons, you can perform the following functions:

- **Power:** Turns the power on and off.
- **Input:** Selects among TV inputs. Each press moves down one item. Pausing for a few moments selects the highlighted item.
- **Volume +:** Increases the volume.
- **Volume -:** Decreases the volume.

## Five buttons (with mute)

If your TV has this style of panel buttons, you can perform the following functions. Note that the order of the buttons might vary from model to model. Examine the panel button labels to determine your TV model's layout.

- **Power:** Turns the power on and off.
- **Input:** Selects among TV inputs. Each press moves down one item. Pausing for a few moments selects the highlighted item.
- **Volume +:** Increases the volume.
- **Volume -:** Decreases the volume.
- **Mute:** Mutes and unmutes the sound.

## Five buttons (without mute)

If your TV has this style of panel buttons, you can perform the following functions. Note that the order of the buttons might vary from model to model. Examine the panel button labels to determine your TV model's layout.

- **Power:** Turns the power on and off.
- **Input +:** Selects the next TV input. Each press moves down one item. Pausing for a few moments selects the highlighted item.
- **Input -:** Selects the previous TV input. Each press moves up one item. Pausing for a few moments selects the highlighted item.
- **Volume +:** Increases the volume.
- **Volume -:** Decreases the volume.

## Seven buttons

If your TV has this style of panel buttons, you can perform the following functions. Note that the order of the buttons might vary from model to model. Examine the panel button labels to determine your TV model's layout.



- **Input:** Selects among TV inputs. Each press moves down one item. Pressing **Channel +** or **Channel -** moves the highlight up or down. Pausing for a few moments selects the highlighted item.
- **Channel +:** Moves the highlighted item up in the current menu.
- **Channel -:** Moves the highlighted item down in the current menu.
- **Volume +:** Increases the volume.
- **Volume -:** Decreases the volume.
- **Mute:** Mutes and unmutes the sound.
- **Power:** Turns the power on and off.

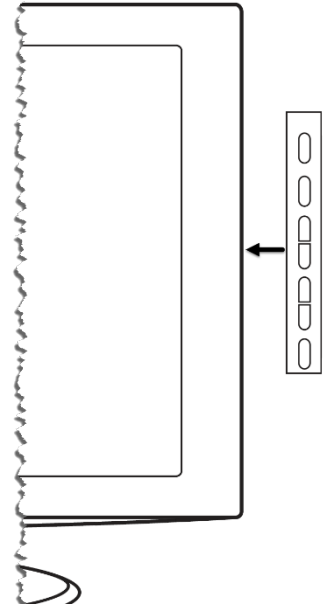

# Guided Setup

With the preliminaries out of the way, it's time to turn on your TV. As the TV starts for the first time, it leads you through Guided Setup, which configures the TV before you start to use it.

During Guided Setup, you'll:

- Answer a few questions
- Provide network connection information
- Get a software update
- Link your TV to your Roku account.
- Connect devices such as a DVD player, game console, or cable box.

## Starting Guided Setup

To start Guided Setup, press **POWER**  on the remote to turn on your TV.

**Note:** *Guided Setup normally runs only once, the first time you turn on your TV. If you need to run Guided Setup again, you must perform a factory reset as explained in [Factory reset everything](#).*

When you first turn on your TV, it will take a few seconds to get itself ready. You'll notice the following things happening:

1. The status indicator blinks every time the TV is busy doing something; in this case it's powering up and getting ready for you.
2. The splash screen appears and the status indicator blinks slowly for a few more seconds. The power-on screen shows a brand logo while the TV starts up.





3. After a few seconds, Guided Setup starts.

## Guided Setup

At this point, you should be seeing the **Language** screen.



1. *Only on models that have a Roku Voice remote:* A few moments after the **Let's get started screen** appears, Guided Setup starts the pairing process for the Roku Voice remote. (You'll know if you have this type of remote because it has a **VOICE**  or **SEARCH**  button just below the purple directional pad.) If the

Roku Voice remote does not pair automatically, follow the instructions on the screen to complete the pairing process.

**Accessibility:** *If you have selected **United States** and **English** language, you can activate the screen reader, a text-to-speech screen reader to help you navigate the TV's menus and commands. To enable the screen reader, press **STAR \*** four times in rapid succession. Repeat to disable the screen reader. (**STAR \*** is located directly below the purple directional pad on the right side of the Roku remote.)*

*If you enabled the screen reader, choosing any language other than English disables it.*

2. Press **DOWN** on the purple directional pad to highlight your preferred language, and then press **OK**.
3. *Some models have a country selection screen:* If you don't see this screen, skip ahead to the next step.

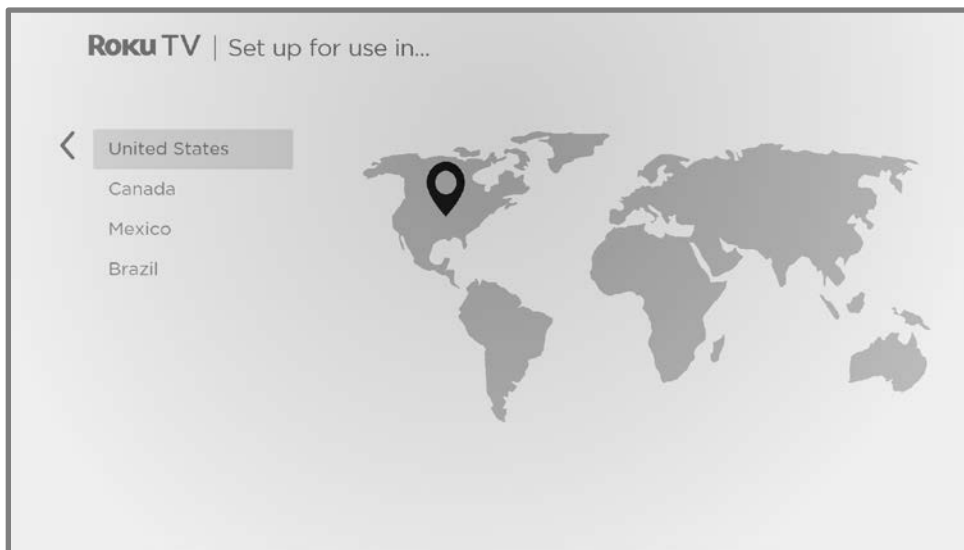

If you see this screen, select your country, and then press **OK**.

**Accessibility:** *If you enabled the screen reader, choosing any country other than **United States** disables it.*



4. Press **OK** to select **Set up for home use**. This is the right choice for enjoying your TV at home. It provides energy saving options as well as access to all features of the TV.

**Note:** *Set up for store use* configures the TV for retail display and is not recommended for any other use. In store mode, some features of the TV are missing or limited. To switch from one mode to the other, you have to perform a factory reset as explained in [Factory reset everything](#), and then repeat Guided Setup.

## Network connection

After you select **Set up for home use**, the TV prompts you to make a network connection. If your TV has both wired and wireless connections, you'll see the following screen. If your TV has only wireless connectivity, skip the following step.

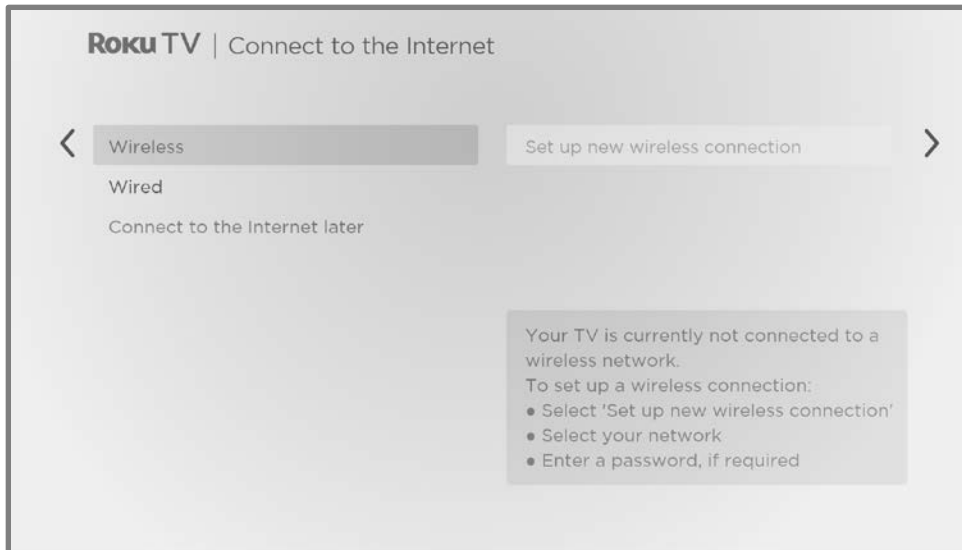

5. *Only on models that display the **Connect to the Internet** screen:* Make a selection:

- **Wireless connection** – Highlight **Set up new wireless connection** and press **OK**. The TV prompts you through wireless setup. Skip ahead to the next step for help with the process.
- **Wired connection** – Highlight **Connect to wired network** and press **OK**. The TV immediately attempts to connect to your wired network, your local network, and then the Internet. Go to Step 9 to continue with Guided Setup.
- **Connect to the Internet later** – If you don't want to connect to the Internet right now, you can select this option, and then press **OK**. You can still use the TV to watch live TV channels, and connect your devices to play games, watch DVDs, or watch channels from a cable box or another streaming device. When you're ready to connect, it's easy. We'll show you how in [Benefits of connecting](#).

**Note:** *If you decide not to connect, Guided Setup skips ahead to setting up the devices that you've connected to your TV. Jump ahead to [Connect your devices](#) to complete Guided Setup.*

6. *On models that have wireless only, and models with both wired and wireless when you've selected **Wireless**:* The TV scans for the wireless networks within

range and displays them in order, with the strongest signals first. In addition to your own wireless signal, the TV might pick up signals from your neighbors.

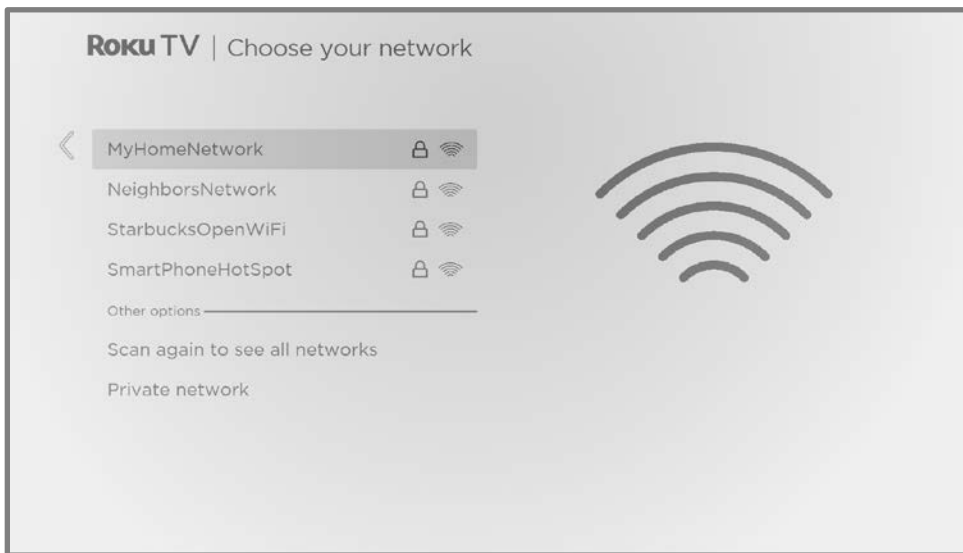

Press **UP** or **DOWN** to highlight the name of your wireless network, and then press **OK** to select it.

**Note:** *Some networks, such as those often found in dorm rooms, hotels, and other public places, require you to read and agree to terms, enter a code, or provide identifying information before letting you connect to the Internet. If your Roku TV detects that you are connecting to such a network, it prompts you through the connection process using your smartphone or tablet to provide the needed information. For more information, see [Using your TV in a hotel or dorm room](#).*

### Other options

- **Scan again / Scan again to see all networks** – The name of this option depends on the number of wireless networks within range.
  - **Scan again** appears if the list already shows all available wireless networks within range. If you don't see your wireless network name in the list, you might need to adjust the location of your wireless router or the TV, turn on your router, or make other changes. When everything is ready, select **Scan again** to see if your network name now appears in the list.

- **Scan again to see all networks** appears if there are more wireless networks than the strongest ones it initially listed. If you don't see your wireless network name in the list, this option displays the complete list. If you still don't see your network name, you might have your router configured to provide wireless service as a "private network."

**Note:** *Highlighting either of these options displays an informational panel with the unique media access control (MAC) address of your Roku TV. You will need the MAC address if your wireless router is configured to use MAC address filtering.*

- **Private network** – If your wireless network name is hidden, it won't appear in the list. Select **Private network** and then press **OK** to display an on-screen keyboard. Use the keyboard to enter your network name. Unless you changed the factory-set network name, you can find the name (also called SSID) on a label on the router.

**Tip:** *Wireless networks that are password-protected display a "padlock" icon adjacent to the name. This icon enables you to know that you are going to be prompted to enter a password after you select that network.*

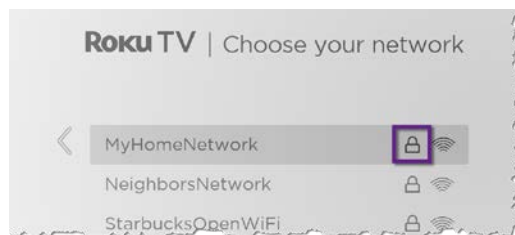

7. *Only if you select a password protected wireless network:* An on-screen keyboard appears. Enter your wireless network password by using the purple directional pad to navigate the keyboard, and pressing **OK** to select a highlighted letter, number, or symbol. When you finish, press **DOWN** to select **Connect**, and then press **OK**.



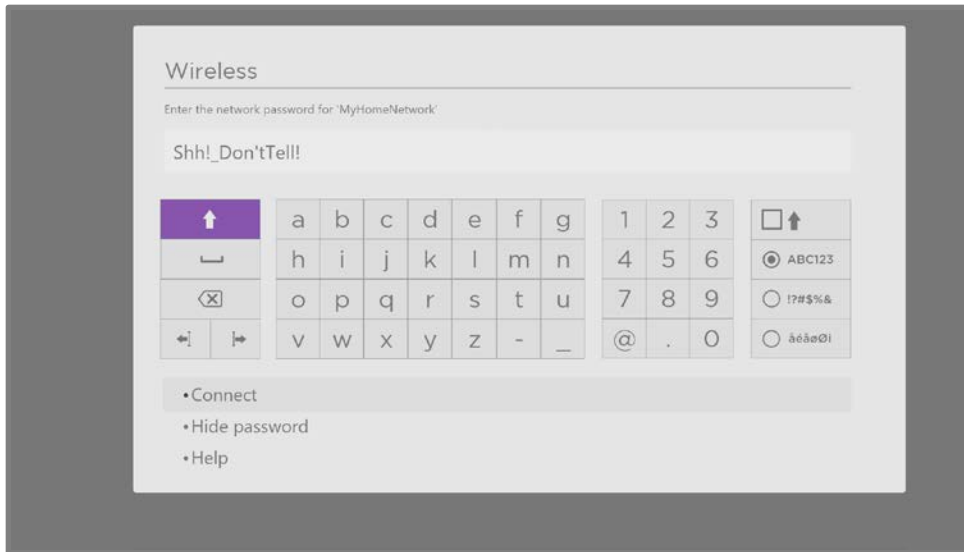

After you select **Connect**, the TV displays progress messages as it connects to your wireless network, your local network, and the Internet.

8. *Only if your TV cannot get the correct time zone and current time from your network service provider:* The **Choose your time zone** screen appears. Press **UP** or **DOWN** to highlight your time zone, and then press **OK**.



**Tips:** *Your TV needs to know the local time zone so that it can correctly display information about the program you are currently watching.*

*Your TV automatically checks for updates periodically. These updates provide new features and improve your overall experience with the TV. After an update,*

*you might notice that some options have moved, and that there are new options or features. This User Guide describes version 11.0. But note also that certain features of the TV might change from time to time independently of Roku TV updates.*

*To determine your current Roku TV software version, go to **Settings > System > About** after you complete Guided Setup. You can download an updated User Guide that matches your Roku TV software version from the Roku TV web site.*

## Activation

After the TV restarts, it prompts you through activation.

9. Use a computer, tablet, or smartphone with an Internet connection to link to a new or existing Roku account.

**Note:** Roku does not charge for activation support – **beware of scams**. For detailed information, see [this Roku Support web page](#)

---

### Why do I need a Roku account?

You need a Roku account for several reasons:

- It links you, your Roku TV, and your other Roku streaming devices to the Roku Channel Store and billing service.
- Streaming content providers know that it's OK to send content you request to your Roku TV.
- Roku can automatically send updates to your device.

You need a Roku account to activate your device and access entertainment across thousands of streaming channels. Linking to a Roku account also activates several advanced features on your TV, such as Guest Mode, the Roku mobile app, and Live TV Pause, to name just a few. Roku accounts are free, and while a valid credit card number is not required to create your account, providing your credit card information makes renting, purchasing, and subscribing to entertainment from the Roku Channel Store fast and convenient.

---

After you activate your TV, the TV gets an acknowledgement, and then adds your newly-selected and pre-existing streaming channels from other Roku

devices on the same account. This process is automatic and takes a few moments—a little longer if you have added a lot of streaming channels.

**Tip:** *Streaming channels from all of the Roku streaming devices associated with your account are synchronized periodically. All of your Roku streaming devices therefore display the same set of channels (subject to compatibility with the device).*

## Connect your devices

Next, Guided Setup helps you set up the external devices that you want to use with it, such as a cable box, Blu-ray™ player, or game console.

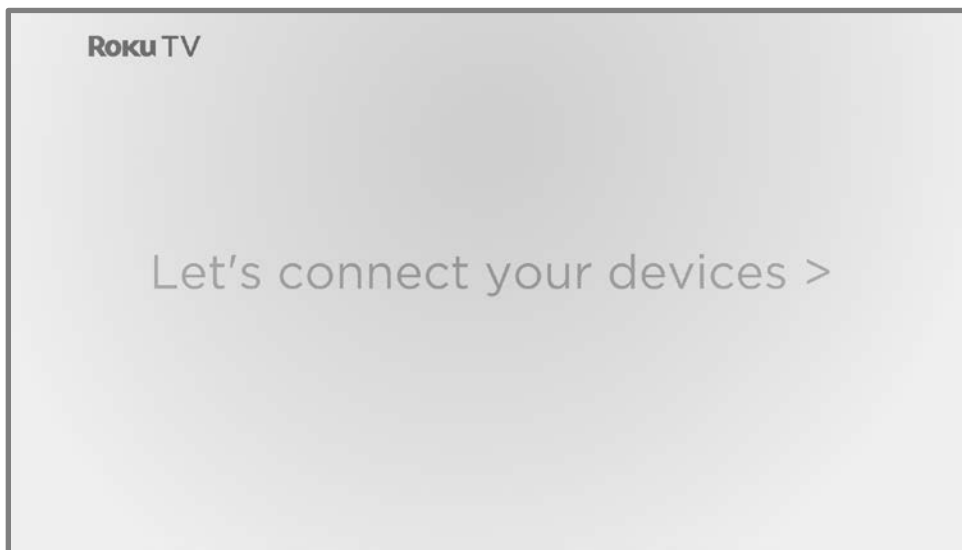

10. Press **OK** to proceed:

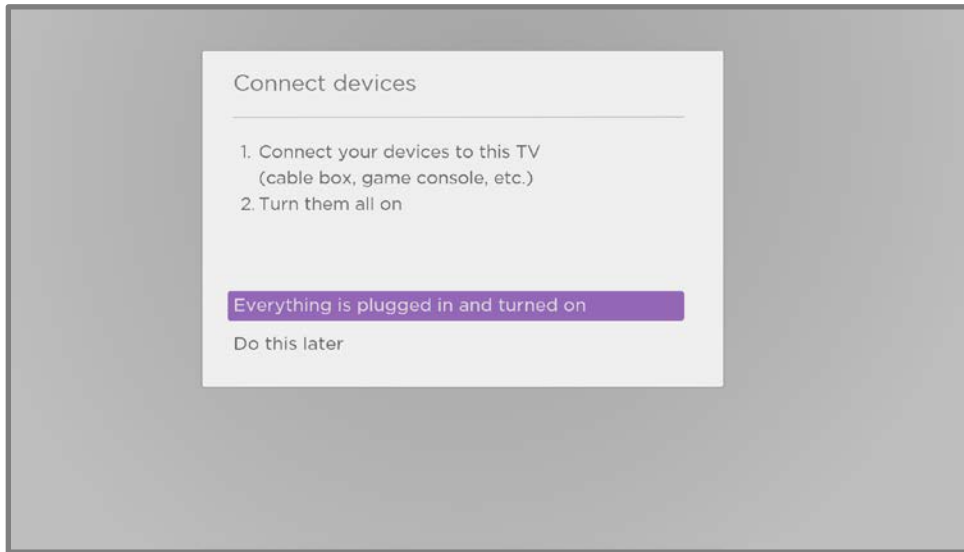

11. Connect all the devices you plan to use with your TV, turn them all on, and then select **Everything is plugged in and turned on**. The TV now takes you step by step through each of its inputs and asks what kind of device you have connected. For each input that has a connected and active device, you can see its picture and hear its sound.

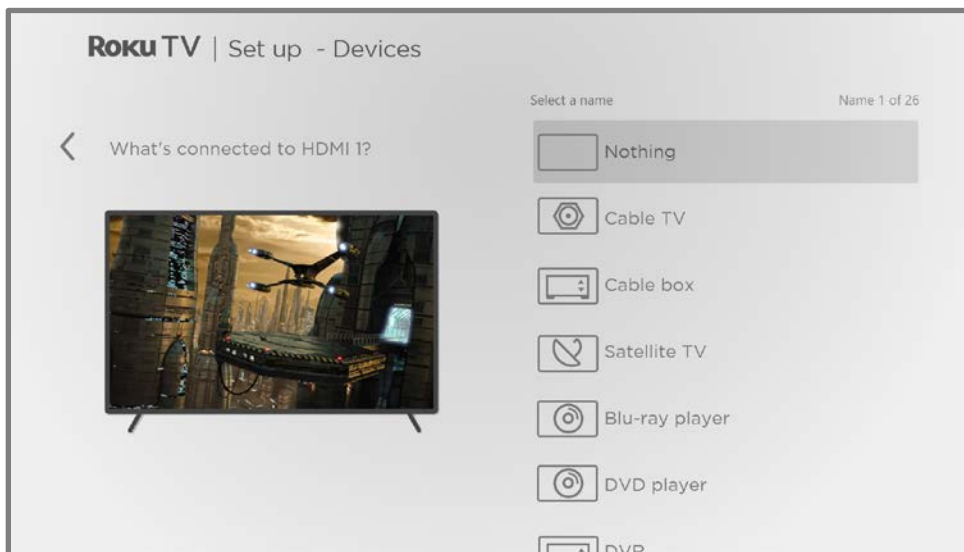

12. Press **UP** or **DOWN** to highlight the label you want to associate with the input, and then press **OK**. If you are not using the input, select **Nothing**, and the input won't appear on the Home screen.

13. While setting up your devices, rather than using the predefined names and icons, you can set a custom name and icon. To do so, scroll up or down to highlight **Set custom name & icon**, and then press **OK**. Follow the instructions on the screen to enter a name and select an icon for the input. See [Rename inputs](#) for more information.

**Note:** *If you specify a custom name for an input, voice commands will not reliably switch to that input. Voice commands typically can only switch among inputs that use built-in names, such as “AV,” and “Cable Box,” and “DVR.”*

14. Repeat the previous step for each input.

You're done with Guided Setup.

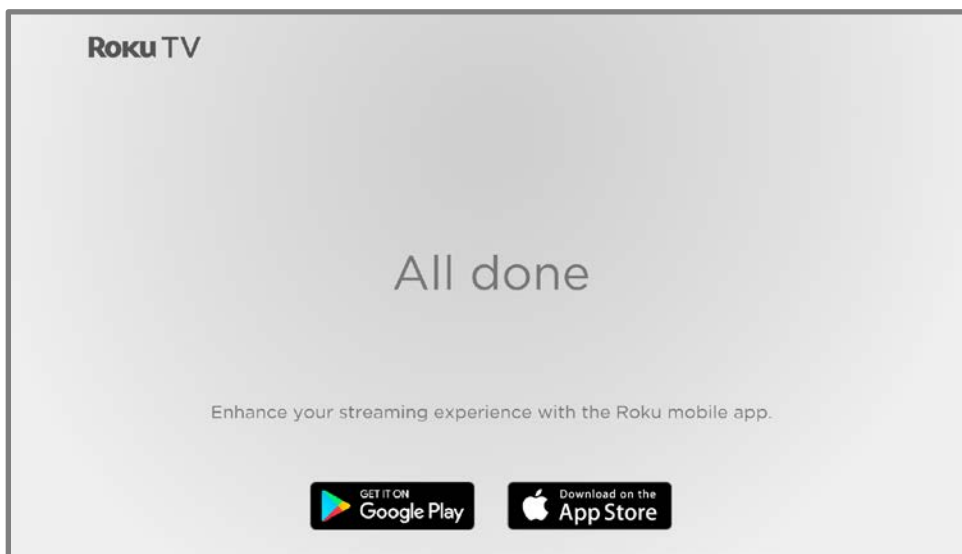

**Note:** *Some Roku TVs, depending on where you live and other factors, show you an introductory video filled with some great hints and tips. If you're not interested in viewing this video, press **HOME**  on the remote to go to the Roku TV Home screen.*

Whenever you press **HOME** , the Home screen greets you.

From here, you can explore everything your TV has to offer. Use the purple directional pad to move around, and then press **OK** to select a highlighted item. We've designed the TV to encourage you to explore, and you can probably figure out most of the capabilities and settings on your own. If you have any questions or difficulties, you can find answers and solutions in this guide.

# The Home screen

The following illustrations show typical Home screens, which vary depending on location, connected mode, selected theme, number of TV inputs enabled, and streaming channels and apps added.

**Note:** *A paid subscription or other payments may be required for some channel content. Channel availability is subject to change and varies by country. Not all content is available in countries or regions where Roku® products are sold.*

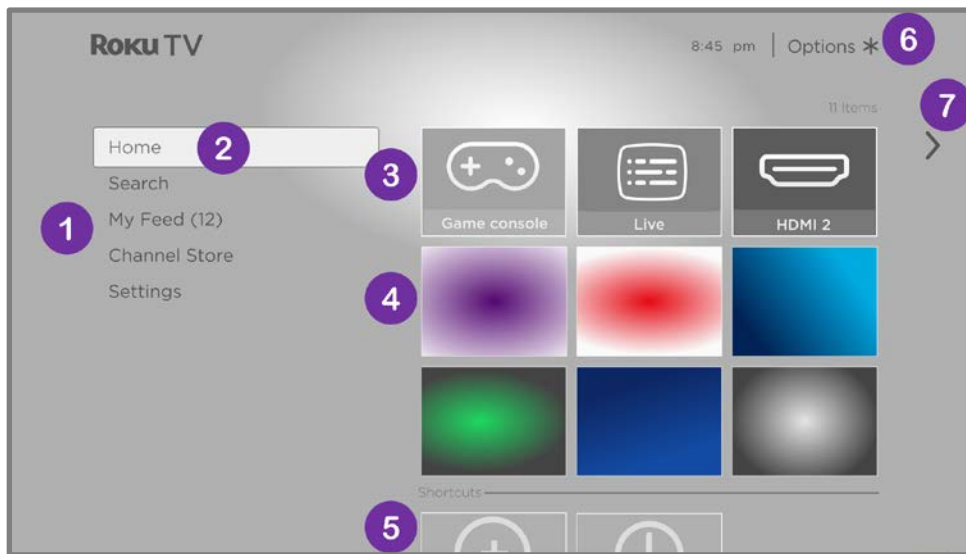

Typical connected Home screen

**Note:** *The options appearing in the left navigation area vary by geographic location and might change from time to time.*

1. Home screen menu—shows options available to you when you are on the Home screen.
2. Highlighted option—press **OK** to select.
3. TV input tiles—select an input to watch the connected device.
4. Streaming channel and app tiles—select a tile and press **OK** to go to the indicated streaming channel or application. You can add any number of channels from the [Roku Channel Store](#).
5. Direct access tiles - shortcuts to often used features.
6. Options hint—press **STAR \*** to see options when this symbol is present.
7. Next screen hint—press **RIGHT** to see the next screen.

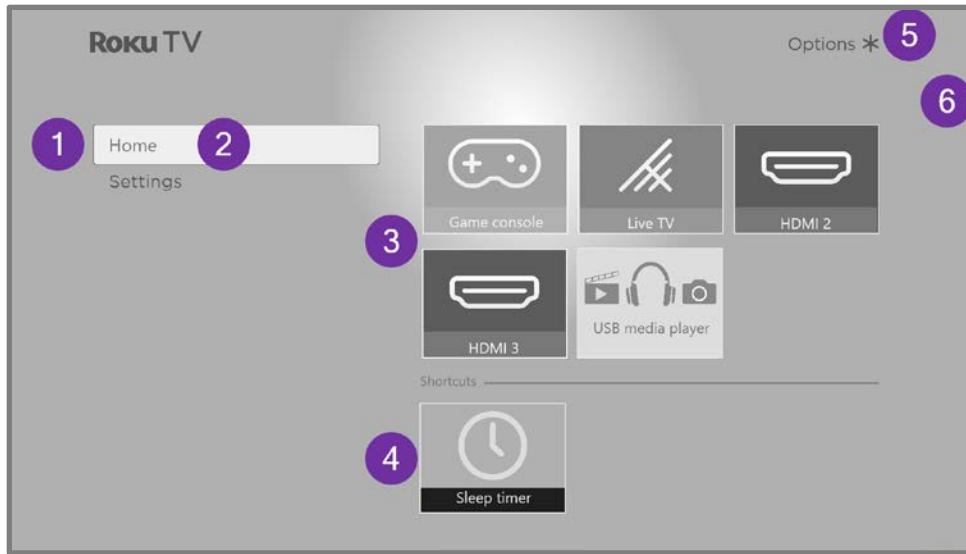

Typical non-connected Home screen

1. Home screen menu—shows options available to you when you are on the Home screen.
2. Highlighted option—press **OK** to select.
3. TV input tiles—select an input and press **OK** to watch the connected device.
4. Direct access tiles – shortcuts to often used features.
5. Options hint—press **STAR \*** for options when this symbol is present.
6. Next screen hint—press **RIGHT** to see the next screen.

## Personalize your Home screen

There are many things you can do to personalize your Home screen and make it just right for you and your family:

- *Only in connected mode:* Add streaming channels by using the **Channel Store** menu option or the **Add Channels** shortcut to browse the [Roku Channel Store](#).
- *Only in connected mode:* [Change the screen theme](#) by going to **Settings > Themes** to find and pick one to suit your mood.
- [Customize the Home screen](#). Hide or show the shortcut tiles that appear at the bottom of your Home screen grid. *Only in connected mode in the United States*, hide Featured Free, My Offers, or Movie Store and TV Store.
- Remove a tile by highlighting it and pressing **STAR \***. Then highlight **Remove input** or **Remove channel** and press **OK**.

- Move a tile by highlighting it and pressing **STAR \***. Then highlight **Move input** or **Move channel** and press **OK**. Use the purple directional pad to move the tile, and then press **OK** to lock it in its new location. Move the shortcut tiles within the shortcut area only. Shortcuts are designed to always appear at the very bottom of the grid, so you can access them quickly by pressing **UP** once when you're at the top of the grid.
- *Only on channels that you have subscribed through your linked Roku account,* manage your subscriptions by highlighting a streaming channel tile and pressing **STAR \***. Then highlight **Manage subscription** and press **OK**. Select **Cancel subscription** and then follow the instructions to confirm your cancellation.
- Rename a TV input tile by highlighting it and pressing **STAR \***. Then highlight **Rename input** and press **OK**. Highlight a new name in the list, and then press **OK** to assign that name to the tile.

Rather than using the predefined names and icons, you can set a custom name and icon. To do so, scroll up or down to highlight **Set custom name & icon**, and then press **OK**. Follow the instructions on the screen to enter a name and select an icon for the input.

**Note:** *If you specify a custom name for an input, voice commands will not reliably switch to that input. Voice commands typically can only switch among inputs that use built-in names, such as "AV," and "Cable Box," and "DVR."*



# Benefits of connecting

## Connecting brings out your TV's full potential!

### Make any night a movie night

Thousands of movies to choose from, across all major streaming movie channels<sup>1</sup>. You'll never run out of something new to watch.

### Check out The Roku Channel

Use The Roku Channel as your new home page for an ever growing assortment of free on-demand and streaming movies, programs, live news, and kid's TV. Use the Live TV Channel Guide within The Roku Channel. Add premium subscriptions to watch many of your favorite channels in one place, and manage them all through your Roku account.

### Get in the groove

Stream endless hours of music from free and subscription-based channels. With almost instant access to thousands of music artists, your favorite beats are just as close as your remote.

### Explore your passions

In addition to the most popular streaming channels, your Roku TV also offers hundreds of other streaming channels to fuel your passions—including fitness, cooking, religion, outdoors, international programming and much more.

### Enjoy FREE trials of popular channels

Your Roku TV comes loaded with special offers, including free trials (if eligible) from popular streaming channels. REMEMBER THAT YOU MUST CANCEL BEFORE THE FREE TRIAL ENDS TO AVOID SUBSCRIPTION FEES.

---

<sup>1</sup> A paid subscription or other payments may be required for some channels. Channel availability is subject to change and varies by country. Not all content is available in countries or regions where Roku® products are sold.

# Take advantage of awesome features

**Powerful, voice-enabled search** lets you use voice commands to find movies and TV programs by title, actor, director, or genre across multiple streaming channels<sup>1</sup>. Additionally, your search commands can include popular movie quotes, and words like “free” and “4K.” In addition to streaming channels, your search results include live TV programs airing in your region.

**Voice commands with multiple device support** let you use Apple Siri<sup>2</sup>, Google Assistant, or Amazon Alexa to change stations, TV inputs, launch streaming channels, and more. Include a location in your command such as “in the bedroom” to specify which Roku device you want to control.

**Automatic account linking** keeps track of supported streaming subscriptions on other Roku devices, so that you won’t have to re-enter your user name and password when adding the same channel on your newly-activated Roku TV.<sup>3</sup>

**Live TV Channel Guide**, *only in the United States*, is an electronic program guide that is available any time you are watching broadcast programs or streaming programs from the Live TV tile. If you prefer, you can hide streaming channels from the Live TV Channel Guide.

**More Ways to Watch**, *only in the United States*, gives you recommendations about the program you are watching on the **Live TV**, **HDMI**, or **AV** input, gives you options to stream the current program from the beginning, the entire season, or the entire series, and recommends other programs with similar themes. It also uses the shows you watch to display ads that are more relevant to you.

**Roku Zones**, *only in the United States*, organize your search results into browsable rows, such as New Release, Free, and Rent or Buy, so you can see at a glance how a program is offered. If you have a 4K Roku TV, results also include a 4K Spotlight Zone.

---

<sup>1</sup> Voice features support English and Spanish languages.

<sup>2</sup> Roku 4K TVs only.

<sup>3</sup> Not all streaming channels currently support automatic account linking.

**4K Spotlight Channel**, *only in the United States*, now has a new look and simpler navigation to help you find 4K entertainment quickly. Launching the channel takes you to the 4K Movies and TV Zone, where you'll find a regularly updated, hand-curated selection of 4K entertainment from channels across the Roku platform. You can browse a wide variety of 4K titles across a number of categories such as Most Popular, Action, and more, to find the perfect movie or program to enjoy in beautiful 4K resolution.

**Live TV Pause** lets you connect a USB drive (not provided) and pause live TV for up to 90 minutes. After pausing, you can play, fast-forward, rewind, and pause again to any point within the rolling 90-minute window.

**Tips & Tricks channel**, *only in the United States*, is packed with videos created by Roku to help you learn more about features, new products, and popular support topics.

**My Offers**, *only in the United States*, show up in the Home screen menu if you are eligible for special offers or discounts on Roku products.

**Mobile Private Listening** on the Roku mobile app lets you listen to streaming programs and “over-the-air” TV programs from the Live TV input on wired or Bluetooth headphones (not provided) connected to your IOS® or Android™ mobile device.

## What is streaming?

Streaming is viewing or listening to video or audio content that is sent over the Internet, or located on a network-connected media server or on a USB device plugged into the TV's USB port.

With streaming, you can buy or rent most programs on demand, when it's convenient for you, and you can also watch live streaming channels and events. Also, you can play, pause, rewind, and fast forward most on-demand streaming programs.

**Tip:** *Some content cannot be paused or skipped. For example, if you are viewing live programming or a program that is supported by ads, you might not be allowed to skip the ads.*

Your Roku TV lets you choose from thousands of streaming channels that offer a huge selection of entertainment:

- Thousands of movies and TV episodes, both live and on-demand
- Unlimited music, live and on-demand
- Tons of live and on-demand sports
- Commercial-free programming for kids and family
- International programming in 22 languages
- 24x7 news and in-depth news commentary

Many streaming channels are free. Some streaming channels let you purchase or rent the latest movie releases or popular TV series. Some channels charge a monthly subscription fee and others are available at no additional cost if you subscribe to a companion service through your cable or satellite provider.

If you have an existing subscription to a streaming provider, you can just sign in with your existing user name and password.

To play streaming content, add one or more streaming channels to your Home screen. Use the **Add Channels** shortcut on the Home screen or the **Channel Store** option on the Home screen menu to go to the Channel Store, and then select the streaming channel you want to add. The channel remains on your Home screen unless you remove it, and you can watch it at any time.

For more information, see [Using the Roku Channel Store](#).

**Note:** *A paid subscription or other payments may be required for some channels. Channel availability is subject to change and varies by country. Not all content is available in countries or regions where Roku® products are sold.*

## What if I didn't connect my TV?

What if you went through Guided Setup and chose **Connect to the Internet later**? No worries. Your Roku TV makes it easy to connect whenever you want. As you move around the Home screen, you'll see several places where you can start the connection process. For example:

- Now and then you'll see a message appear on the panel to the right of the Home screen offering a **Connect Now** option. You can highlight and select the **Connect Now** option to get started.
- Use the **Connect and activate now** option. From the Home screen menu, select **Settings**, then **Network**, and then **Connect and activate now**.
- If you want to start over from the beginning, do a **Factory reset**, and then go through Guided Setup again. This time, select your home network when prompted.

# Setting up live TV

In addition to the other entertainment possibilities of your Roku TV, you might want to watch broadcast channels from an antenna or cable TV provider connected to the **ANT/CABLE** input. On your Roku TV, you can watch broadcast TV in much the same way you watch other entertainment choices: select the **Live TV** tile from the Home screen.

The first time you select the **Live TV** tile, you have to set up the TV tuner. Setting up the TV tuner scans for active channels and adds them to your Live TV channel list.

---

## Why do I have to set up the TV tuner?

Not everyone needs to use the TV tuner. For example, you might have a set top box provided by a cable or satellite company that receives all of your channels. Most of these set top boxes use an HDMI® connection.

More and more people are watching only streaming TV and do not have a TV antenna or cable/satellite service. If you don't need the TV tuner, you can bypass setting it up and instead remove it from the Home screen as explained in [Remove unwanted tiles](#).

When you set up live TV, the TV scans the signals on its antenna input for channels with a good signal, and adds those to the channel list, skipping dead channels and channels with a very weak signal.

The TV lets you add two analog channels, even if they have no signal, for the purpose of using an older set top box, VCR, or game console that can only output a signal on analog channel 3 or 4. Typically, you'll only need one of these channels, but both are provided to make setup simpler. You can hide the one you don't want as explained in [Edit live TV channel lineup](#).

---

## How do I set up the TV tuner?

1. Make sure your antenna or TV cable (not provided) is connected to the TV's **ANT/CABLE** input.
2. On the Home screen, select the **Live TV** tile. If it is not on your Home screen, go to **Settings > TV Inputs** to add it.
3. Read the simple on-screen instructions, and then select **Start finding channels**.

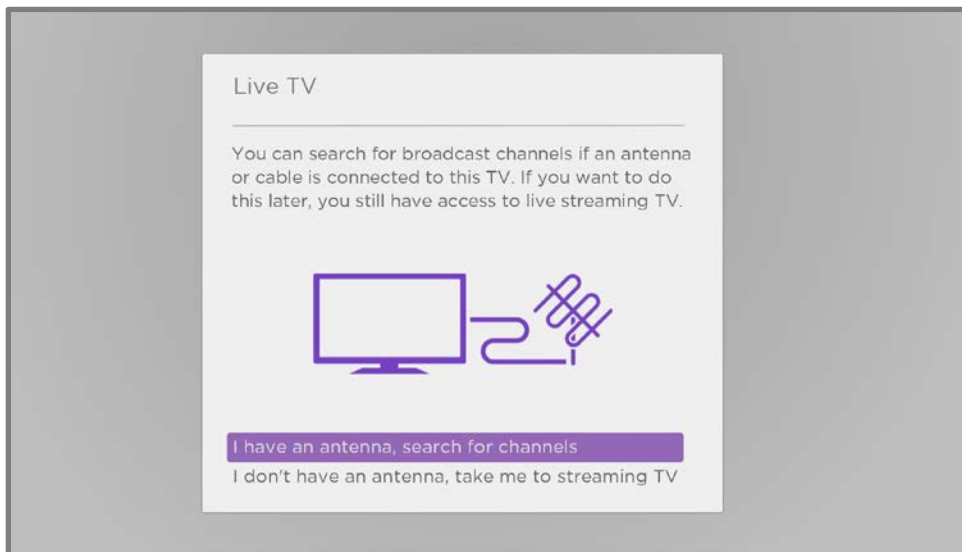

4. If prompted, select your time zone. You'll only need to do this if the TV can't figure out your time zone from your Internet connection.

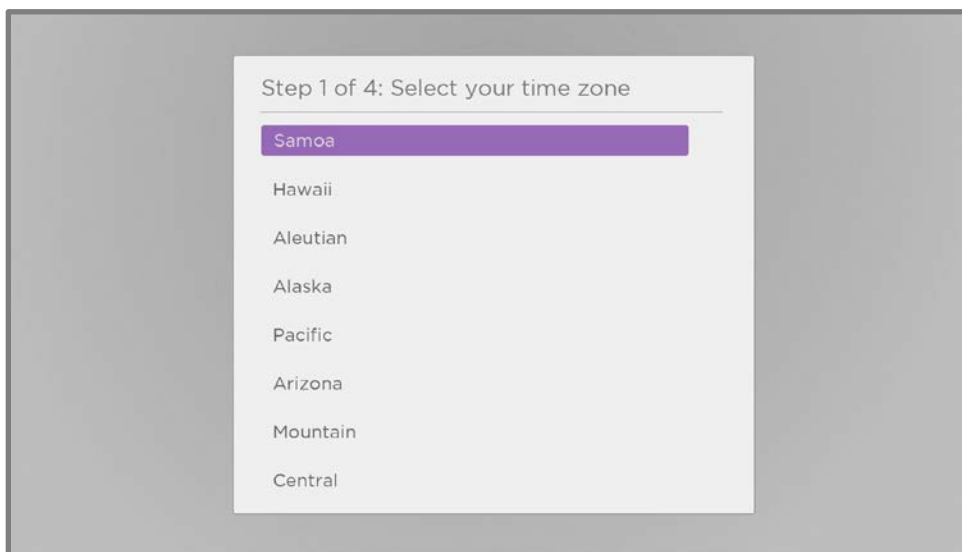

---

## Why does the TV need my time zone?

The TV needs to know your time zone so that it can correctly display time information about the program you are currently watching. In most cases, it can get the time zone automatically and skips this step.

---

- When prompted, select whether to add analog channels 3 and 4. These channels enable you to connect older set top boxes, VCRs, or game consoles.

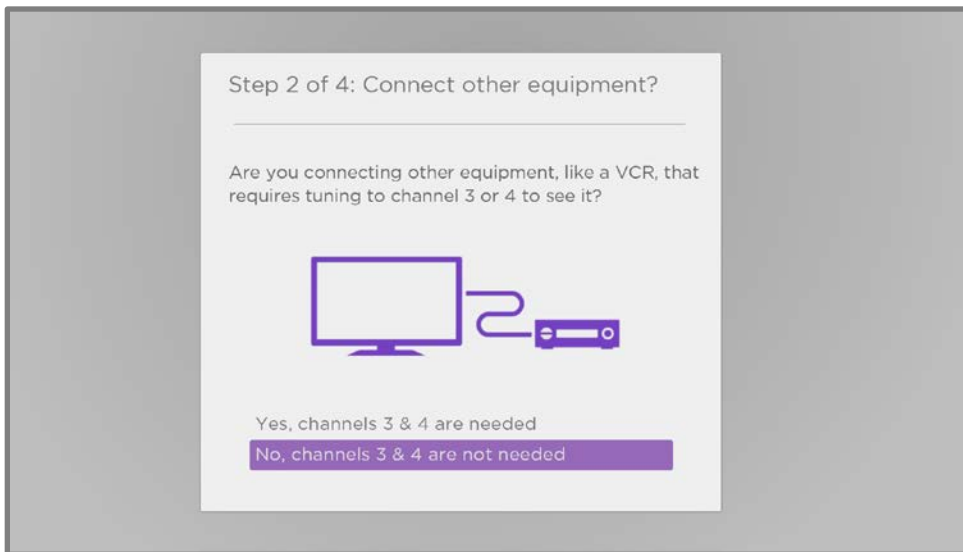

- Wait while your TV scans for antenna channels ...

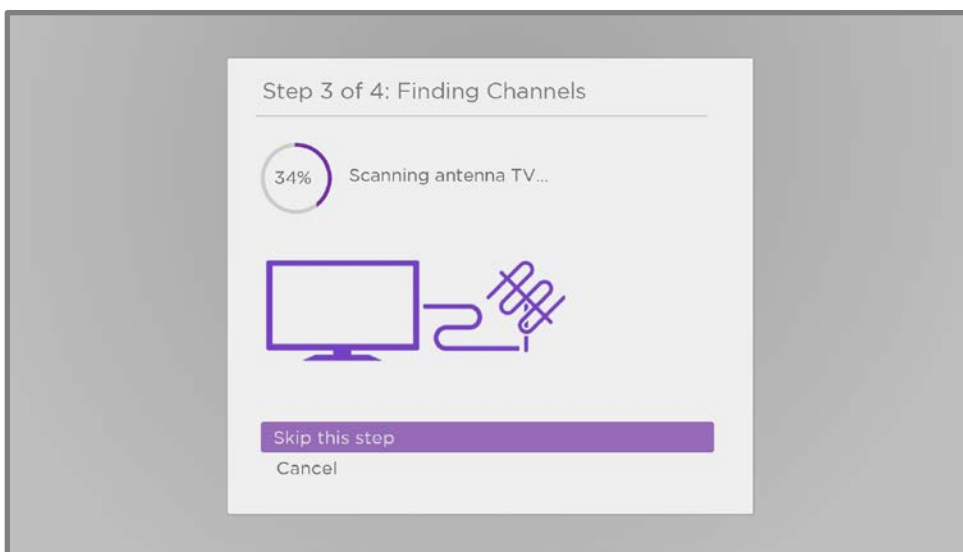



... and then cable TV channels.

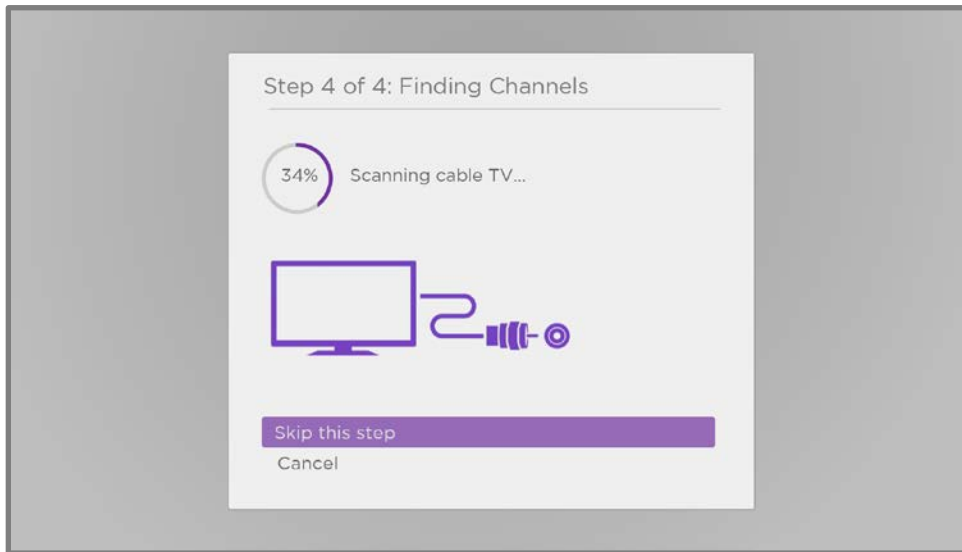

Scanning for channels can take several minutes.

**Tip:** *If you don't have a cable TV provider, or if you use a set-top box to receive cable TV channels, you can save time by skipping the cable TV portion of the channel scan.*

7. When the channel scans finish, the TV shows the number of channels it added.

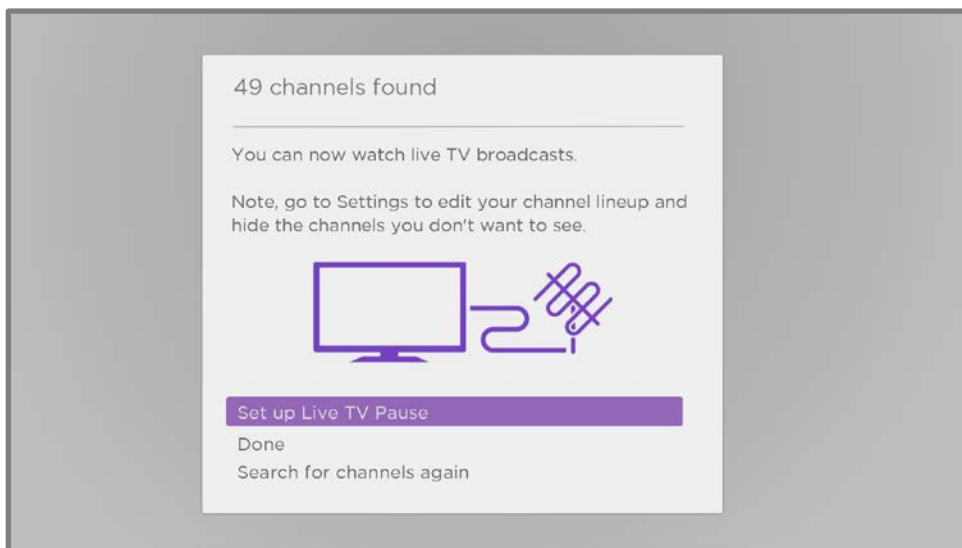

8. *Only in connected mode*, you have the option of setting up Live TV Pause. [Pausing live TV](#) explains how to set up and use this feature. If you don't want to set up Live TV Pause, or if this option is not available to you, select **Done** to start watching live TV.

**Tip:** *Repeat the channel scan from time to time to make sure you are receiving all of the latest channels. Broadcasters and cable providers add and remove channels, move channels to different parts of the spectrum, and change the power levels of their channels periodically. Your reception and picture quality depend on the position of your antenna and on your location relative to the antennas of broadcasters in your area. To repeat the channel scan, use the purple directional pad to highlight the **Live TV** tile, press **STAR \***, select **Scan for channels**, and then press **OK**.*

*You'll also have to repeat the channel scan if you remove and re-add the **Live TV** tile from the Home screen or perform a factory reset.*

Now, you're ready to watch live TV! While you're watching, try the following tips:

- Press **UP** or **DOWN** to change channels.
- Press **LEFT** to display the channel list (non-connected mode) or Live TV Channel Guide (connected mode), and then press **UP** or **DOWN** to select a channel to watch. Or press **REWIND ◀◀** or **FAST FWD ▶▶** to jump through the channel list or Live TV Channel Guide<sup>1</sup> a page at a time.
- Press **OK** to display information about the current program.
- Press **STAR \*** to see options for picture and sound settings.
- *Only in connected mode*, use a Roku Voice remote, the Roku mobile app, Google Assistant, or Amazon Alexa to search for programs by title, actor, director, or genre<sup>2</sup>. The TV or the Roku mobile app displays the results along with the streaming channels that offer the requested content. *Only in the United States*, the results also include Live TV programs.

**Note:** *If you do not have a Roku Voice remote, you can use the Roku mobile app to search. For more information, see [Roku mobile app](#).*

---

<sup>1</sup> Live TV Channel Guide is available only in the United States.

<sup>2</sup> Voice features support English and Spanish languages when the corresponding TV language is selected.

# Using your TV

This section provides information on using the day-to-day features of your TV.

## Status indicator

Your TV has a single status indicator. It goes on and off and blinks in different ways depending on the status of the TV, as shown in the following table:

TV CONDITION	STATUS INDICATOR	MEANING
On (screen is active)	Off	Screen is communicating that TV is on.
Screensaver (screen is active)	Off	Screen is communicating that TV is on.
Off (no power)	Off	TV is not connected to power.
Off (standby)	On	TV is connected to power and is ready to use.
Starting up from off state	Slow pulsing blink until startup completes	TV is doing something.
On (receiving update from USB)	Slow pulsing blink until update completes	TV is doing something.
Remote command received	Dims on/off once	TV has received your command.
Network connection lost	Two short blinks, pause, repeat	TV was connected and paired with a Roku account and now has no network connection.
Powering down to standby mode	Slow pulsing blink until the TV reaches standby.	TV is doing something.

## Standby mode energy savings

When you turn off your TV, it remains in a higher power mode for a few minutes, after which it goes into a very low power standby mode. If you turn on the TV again before it has entered the very low power mode, it turns on immediately. After the TV goes into the lower power standby mode, it takes a few seconds longer to start up.

*Only in connected mode*, you can optionally enable **Fast TV start**. When this option is enabled, your TV starts up almost immediately regardless of how long it has been turned off, but uses somewhat more power in standby mode. Fast TV start also gives you access to some additional features, such as turning on the TV with voice commands and turning off the screen when listening to music. For more information, see [Fast TV start](#).

## Getting help

*Only in connected mode*, you can get two different types of help:

- **Tips and tricks videos:** *Only in the United States*, from the Home screen menu, navigate to **Settings > Help** and select **Roku Tips & Tricks**.
- **Help with Roku voice:** Navigate from the Home screen menu to **Settings > Help** and select **Voice help**. Or from your Roku voice remote or the Roku mobile app, press **VOICE**  and say "Help."

## Opting in to Smart TV experience (U.S. only)

Only in connected mode in the United States, the first time you select live TV, an HDMI input, or AV input, your TV offers to enable the Smart TV experience. If you decide to enable it at this time, you're all set to enjoy its recommendations and features.

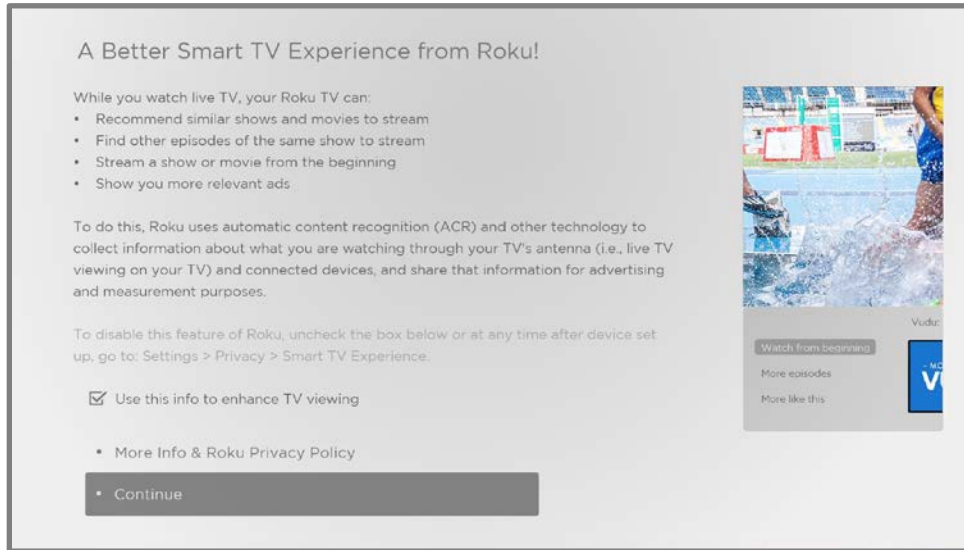

The Smart TV experience uses automatic content recognition (ACR) and other technology to collect information about what you watch on live TV, and on devices like media players and cable boxes connected to the **HDMI** or **AV** inputs. Opting in means that you give permission to analyze the programs you watch for the purpose of making recommendations, as well as showing ads that are more relevant to you.

If you decide not to enable the Smart TV experience at this first opportunity, you can enable it later. Or, if you decide you'd rather not use the feature, you can disable it, but be aware that previously collected information is retained and not deleted.

### Disable Smart TV experience

If you decide you want to disable Smart TV experience, follow these steps:

1. From the Home screen menu, go to **Settings > Privacy > Smart TV experience**.
2. Navigate to the right to highlight **Use info from TV inputs**.
3. Press **OK** on the remote to clear the check box.

## Disable Auto Notifications

If you want to keep the Smart TV experience enabled, but you do not want to see notifications while you are watching programs, you can disable notifications. To do so, follow these steps:

1. From the Home screen menu, go to **Settings > Privacy > Smart TV experience**.
2. Navigate to the right to highlight **Use info from TV inputs**.
3. Press **DOWN** to highlight **Enable auto notifications**.
4. Press **OK** to clear the check box.

**Note:** *These settings do not affect recommendations for More Ways to Watch that you see in the Live TV Channel Guide when watching live TV channels. Those recommendations show up only in the Live TV Channel Guide and do not rely on ACR technology.*

## Watching live TV channels

Select the **Live TV** tile in the Home screen. Your TV remembers the last channel you watched and starts with that channel playing.

### Changing channels

To change channels, you can do any of the following:

- Press **UP** to change to the next higher channel.
- Press **DOWN** to change to the next lower channel.
- Press **LEFT** to display the channel list or [Live TV Channel Guide](#)<sup>1</sup>, and then press the arrow keys to select the channel or program you want to watch. Press **REWIND** ◀◀ or **FAST FWD** ▶▶ to move through the list one page at a time. When you've highlighted the channel or program you want to watch, press **OK**. (If you decide you don't want to change channels, press **BACK** ←.)

---

<sup>1</sup> Live TV Channel Guide is available only in connected mode and only in the United States.

- *Only if Live TV Pause is not enabled, press **REPLAY** ↺ to jump to the previous channel. Press again to return to the channel you were watching before you pressed **REPLAY** ↺.*

**Note:** *If **REPLAY** ↺ is not available on your remote, you can use this feature in the Roku mobile app. For more information, see [Roku mobile app](#).*

## Using the Live TV Channel Guide (U.S. only)

*Only in connected mode in the United States, use the Live TV Channel Guide to find both over-the-air and live streaming TV programs. The Live TV Channel Guide lets you scroll through all the TV channels you receive (except those you have hidden, if any), plus a large number of live streaming programs. You can see what's on right now and the upcoming 14 days.*

For live, over-the-air TV programs, you can use More Ways to Watch to find the program you're watching and start watching it from the beginning from one of your streaming channels. Your clue that there are More Ways to Watch a program is a purple star (\*) next to the program name in the guide.

For example, you might turn on your TV at 10 minutes past the hour and discover you are missing the current episode of *Empire*. But there is a purple star next to the program title, so you can press **STAR \*** and find that there are several streaming channels where you can watch the current episode from the beginning. You also can find more episodes of *Empire*, and other programs that have a similar theme.

**Note:** *A paid subscription or other payments may be required for some streaming channels.*

To open the Live TV Channel Guide, press **LEFT** while watching live TV. It opens with the name of the current program highlighted, and a lot more information.

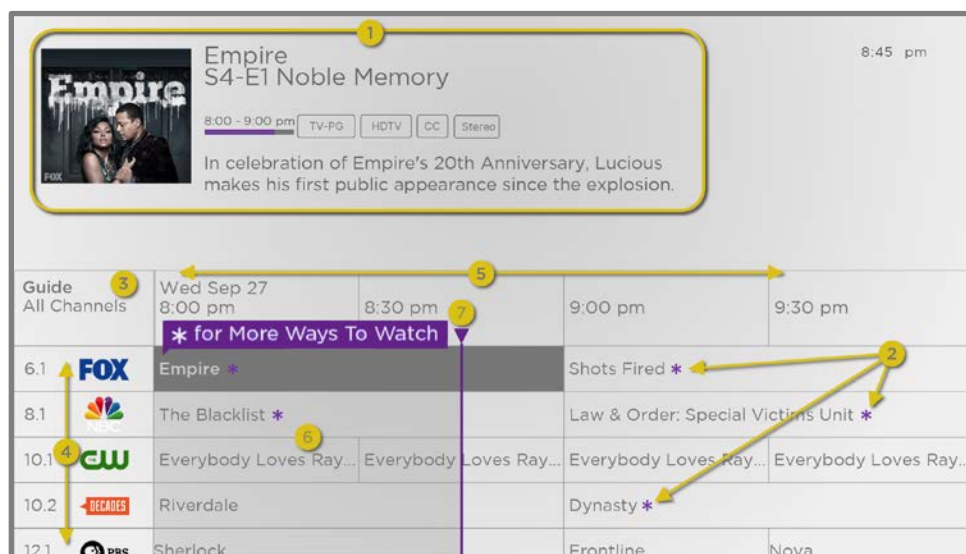

1. Program information for the highlighted program. See [Viewing program information](#) for details.
2. More Ways to Watch indicator. See [More Ways to Watch](#) for more information.
3. Channel filter. Currently set to **All Channels**.
4. Channel list. Navigate **UP** or **DOWN**.
5. Time slots. Navigate **LEFT** or **RIGHT**. Press **FAST FWD** **▶▶** or **REWIND** **◀◀** to skip ahead or back a screen at a time.
6. Program list. Shaded area is prior to the current time.
7. Progress bar. Shows the current time within the listed programs.

When you are viewing the current time slot, notice that the Live TV Channel Guide shows a light gray background for portions of programs before the current time, and a dark background for programs and portions of programs that have not yet aired. The line dividing these two zones is the progress bar.



## Navigating the Live TV Channel Guide in connected mode (U.S. only)

*Only in connected mode in the United States:*

- Use the purple directional pad to move up, down, left, and right.
- To switch to a program that is currently in progress, highlight it, and then press **OK**. (Note that pressing **OK** on a past or future program does nothing.)
- To return to the current time after navigating to a different time slot, press **REPLAY** ↺.
- To return to the currently airing program without causing a channel change, press **BACK** ←.
- To see [More Ways to Watch](#), highlight any program that has a purple asterisk (\*), and then press **STAR \***. While using the Live TV Channel Guide, navigate all the way to the left so that a channel number is highlighted, and then press **STAR \*** to open the **Channel options** dialog.

## Changing channel options in connected mode (U.S. only)

*Only in connected mode in the United States, while using the Live TV Channel Guide, navigate all the way to the left to the channel number column, and then press **STAR \*** to open **Channel options**.*

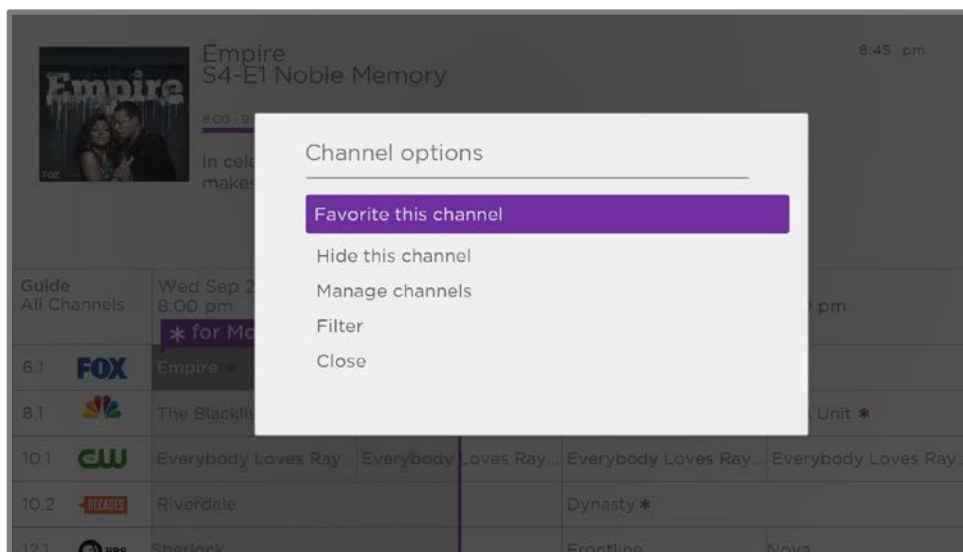

**Favorite/Unfavorite this channel** – Select this option to make the selected channel a favorite. Select again to remove the channel from your favorites. Use the **Filter** option to show only favorite channels.

**Hide/Unhide this channel** – Select this option to hide the current channel. Select again before moving on to unhide the channel if you hid it by mistake. But note that once you close the dialog, you cannot access the channel to unhide it. Instead, use the **Manage channels** option to unhide hidden channels.

**Manage channels** – Opens the **Manage Channels** menu where you can edit the channel lineup and mark certain channels as favorites. See [Manage channels](#).

**Filter** – Opens the **Filter** dialog where you can choose to see:

- **All Channels** – Show all channels that you can receive.
- **Recents** – Show only recently tuned channels in the order in which you watched them.
- **Favorites** – Show only channels you have marked as favorites.

## Viewing program information

You can view program information in different ways:

- When you are viewing a program and no other guides or menus are open, press **OK** to view program information in a banner at the bottom of the screen. This program information appears both in connected and non-connected modes. The following illustration shows the information that is available.

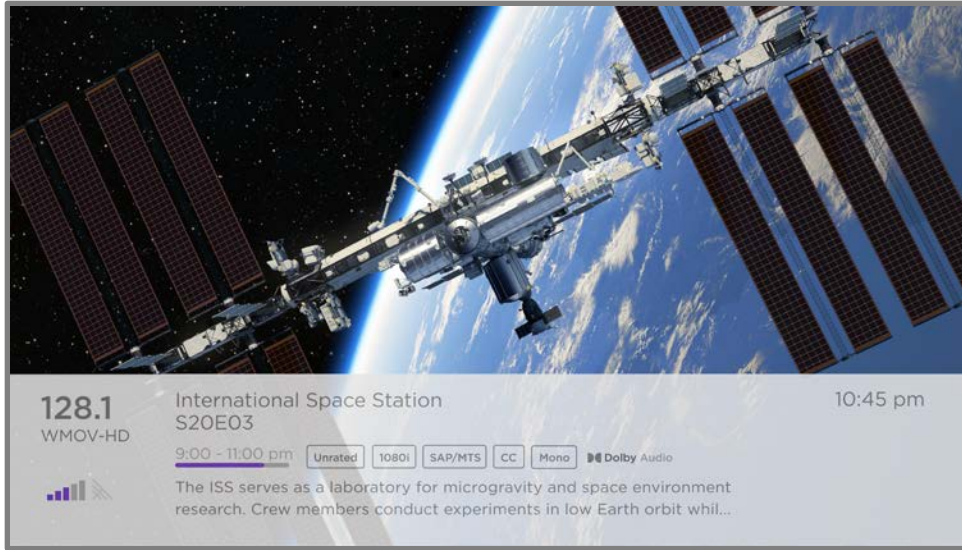

### Program information banner

Program information might include any or all of the following, depending on availability within the broadcast information:

- Channel number
- Channel call sign
- Signal strength
- Program title and episode name/number
- Start time, end time, and graph of program length showing current position
- Content rating
- Video resolution (480i, 480p, 720p, 1080i, 1080p, 4K)
- Frame rate (24Hz, 30Hz, 60Hz for television sources, 60Hz, 70Hz, 72Hz, 75Hz for computer sources)
- Audio format (Mono, Stereo, Dolby Audio™ logo)
- Audio features (SAP/MTS)
- *Only on select 4K models:* HDR or Dolby Vision™<sup>1</sup> logo (HDMI® and streaming sources)
- Closed captioning (CC)
- Current time
- Program description.

**Tip:** *If you've set up Live TV Pause and you're watching live TV, you'll also see a progress bar showing the current playback position within the rolling 90-minute pause time. For more information, see [Pausing live TV](#).*

---

<sup>1</sup> The Dolby Vision™ logo appears only on Dolby Vision™-certified models when displaying Dolby Vision™ content.

- *Only in connected mode in the United States*, view program information for any program listed in the Live TV Channel Guide. Press **LEFT** while watching live TV to see the Live TV Channel Guide. For more information, see [Using the Live TV Channel Guide](#).

## Adjusting settings while watching a program

Press **STAR \*** to display the **TV settings** menu. Press **UP** or **DOWN** to highlight an option, and then press **LEFT** or **RIGHT** to change the setting. The topic [Adjusting TV settings](#) explains each of the settings in detail.

## Pausing live TV

Live TV Pause gives your Roku TV the ability to pause, play, fast forward, and rewind live TV received on the **ANT** input. You can pause live TV for up to 90 minutes.

### Requirements

To use this feature, you need to:

1. Connect your TV to the Internet. If you didn't connect during Guided Setup, see [What if I didn't connect my TV?](#).
2. Provide your own dedicated USB flash drive (thumb drive) with the following minimum specifications.
  - 16 GB
  - 15 Mbps read/write speed
  - USB 2.0 compliant

A USB flash drive (thumb drive) meeting the minimum requirements is highly recommended over an externally-powered hard disk drive. Note that you can use any larger size drive—there is no limit to the maximum size—but using a larger drive does not extend the 90-minute pause time.

**Important:** *After warning you and giving you a chance to cancel Live TV Pause setup, all existing content on your USB drive is erased when you enable this feature.*

3. Connect your USB drive to the TV's USB port.

**Important:** *Some TV models have more than one USB port. You can connect your Live TV Pause USB drive to any port, but make sure that nothing is connected to other USB ports while enabling Live TV Pause. Reconnect other USB devices after you have finished enabling Live TV Pause.*

4. Enable Live TV Pause, as explained in the following topic.

## Enabling Live TV Pause

You can start setting up Live TV Pause in any of the following ways:

- After completing a channel scan, select **Set up Live TV Pause** from the available options.
- Press **PLAY/PAUSE ▶||** on the Roku remote while watching a live TV channel.
- Highlight the **Live TV** tile on the Home screen, press **STAR \*** on the remote, and then select **Enable Live TV Pause**.

After starting setup of Live TV Pause in any of these ways, the TV prompts you through the steps needed to enable this feature. Setup takes only a few moments.

**Note:** *Use of a USB hub is not supported.*

## Using Live TV Pause

If you have used the Roku remote to watch streaming channels, using Live TV Pause should be very familiar to you.

- While watching a digital live TV channel, press **PLAY/PAUSE ▶||** to pause or play the content. After the TV program has been paused for 90 minutes, the TV resumes playing from the point in the program where you paused it.
- After watching a channel for a while, press **REWIND ◀◀** to jump back up to the point where you first started watching the channel, up to 90 minutes.
- After pausing or rewinding, press **FAST FWD ▶▶** to jump ahead up to the point where you are once again watching the live TV program.

- Press **FAST FWD** ►► or **REWIND** ◀◀ repeatedly to cycle through 1x, 2x, and 3x skip speeds. Press **REPLAY** ↺ to play back the last several seconds of the program.
- When the program is paused, press **LEFT** or **RIGHT** to move backward or forward through the program approximately 10 seconds per press. Small frames appear across the screen to identify your location in the program.

**Note:** If **REPLAY** ↺ is not available on your remote, you can use the Roku mobile app. For more information, see [Roku mobile app](#).

Whenever you use any of the Live TV Pause features, the TV momentarily displays a progress bar:

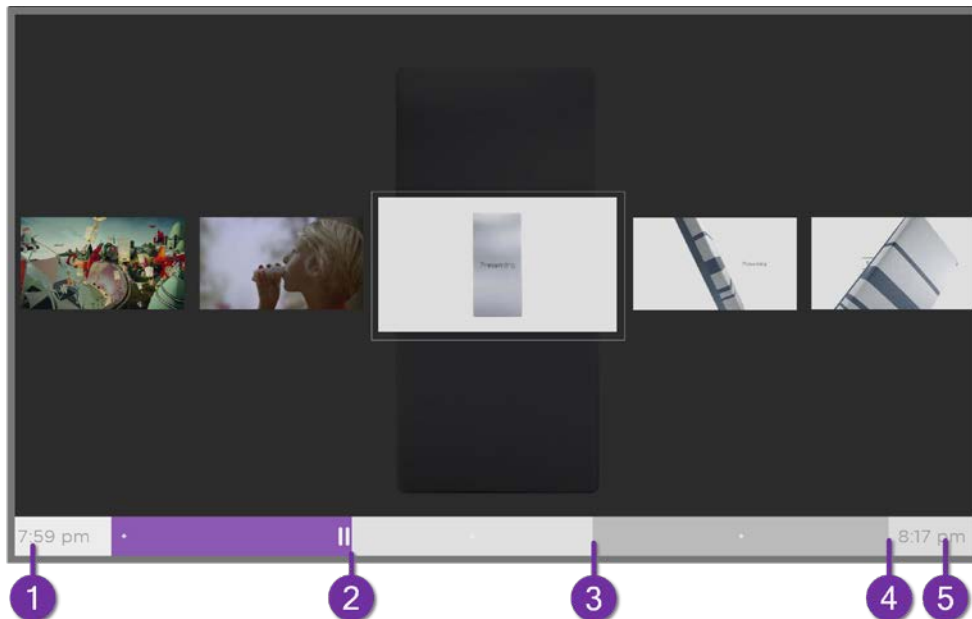

1. Time at the current playback position.
2. Current playback position
3. Extent of pause time, representing the amount of time this channel has been buffered, up to 90 minutes.
4. 90-minute mark, representing the maximum extent of pause time.
5. Current time.

The progress bar also shows tick marks at each half hour point, to help you locate the boundaries where one program ends and a new one begins.

## Notes about Live TV Pause

- You can use Live TV Pause only with digital broadcast and cable channels received through the TV's **ANT** input (ATSC and Clear QAM channels).
- Changing channels erases and restarts the Live TV Pause buffer.
- Returning to the Home screen, selecting another input, or turning off the TV erases and resets the Live TV Pause buffer.
- Disconnecting the USB drive erases the Live TV Pause buffer.

## More Ways to Watch (U.S. only)

*Only in connected mode in the United States,* More Ways to Watch gives you recommendations about the programs you're watching on the **ANT**, **HDMI**, and **AV** inputs. You will automatically get these recommendations in the Live TV Channel Guide for live TV programs. However, before you can get recommendations for programs you're watching through the **HDMI** or **AV** inputs, you must opt into the Smart TV experience to acknowledge that you want to allow the TV to use automatic content recognition (ACR). See [Opting in to Smart TV experience \(U.S. only\)](#) for details.

## Using More Ways to Watch

Not every program provides recommendations. As you use More Ways to Watch, be aware that you'll only see suggestions on your TV when all of the following conditions are met:

- Your TV is operating in connected mode in the United States.
- You have enabled **Smart TV experience** if you are watching programs through an **HDMI** or **AV** input. (If you are watching live TV from the **ANT** input, this setting does not matter.)
- The program you're watching contains the information needed to identify it. Note that some programs, such as the daily news, typically do not activate More Ways to Watch.
- At least one participating streaming channel offers the movie or TV program you are watching, or other episodes, or more programs like the one you are watching.

If all of these conditions are met, you can view the suggestions. More Ways to Watch recommendations appear in two different places:

- When watching the **HDMI** and **AV** inputs, you'll see a **More Ways to Watch** notification in the lower right corner of the screen for a few seconds unless you have disabled **Enable auto notifications**. Press **STAR \*** to see the list of matching programs.

**Note:** *After this banner disappears, you can restore the **More Ways to Watch** prompt by pressing **OK**.*



- In the Live TV Channel Guide, all programs that meet the criteria for More Ways to Watch display a purple asterisk \* next to their titles:

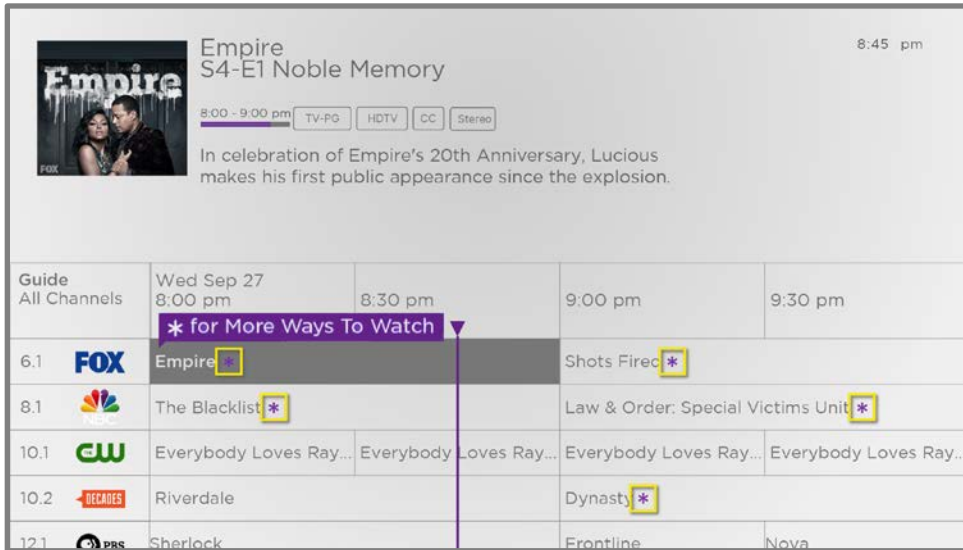

Highlight the program of interest and press **STAR \*** to see recommendations.

Regardless of how you got to this point, the options you'll see depend on the type of program you're watching and the available ways there are to watch, so you might see any or all of the following:

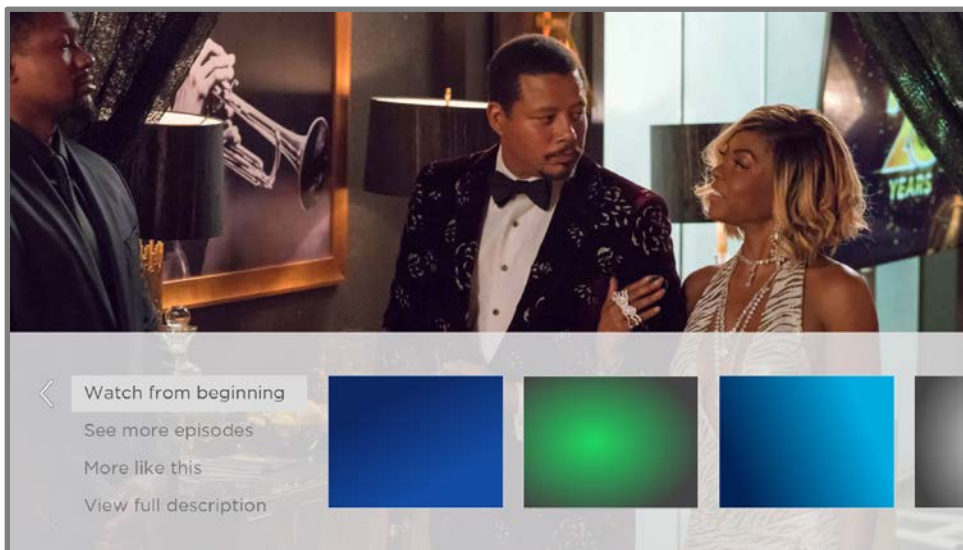

- **Watch from beginning** – Streaming channels on which the same TV program or movie is available. Often, this option does not appear on first

run programs, because streaming content typically is not available until some time after the program is first broadcast.

- **See more episodes** – Streaming channels where you can find other episodes of the TV program you are watching. Does not apply to movies.
- **More like this** –TV programs or movies with a similar theme.
- **View full description** – Full description of the selected program.

Press **DOWN** to select an option, and then press **RIGHT** to select the streaming channel you want to watch.

Assuming you've already added the channel and completed any required sign-in, More Ways to Watch takes you directly to the program in the streaming channel where you can select and watch the program. Otherwise, it prompts you to add the channel and, if you do, then takes you to the program.

## Getting the most from More Ways to Watch

- Streaming channels you've already installed appear first in the list of suggestions.
- When you select a streaming channel, you leave the program you are currently watching.
- If you've used the Live TV Pause feature to pause the program, your paused program buffer is deleted. In other words, you cannot return to a live TV channel and resume watching from where you left off.

## Automatic network recommendation

Your home might have multiple wireless networks, each with its own characteristics. While you are streaming and during manual network scans, your TV checks the wireless networks nearby to make sure you are getting the optimum viewing experience.

If your TV determines that a better connection is available while you are watching streaming content, it recommends that you switch by displaying a message in the lower portion of the screen:

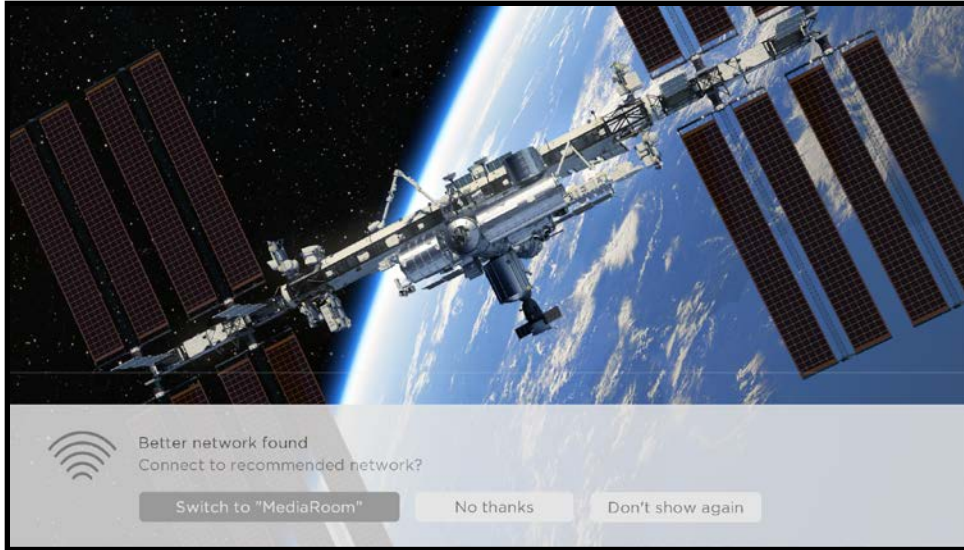

When this happens, you can select the appropriate button to accept or reject the recommendation, or you can select **Don't show again** if you do not want to use this feature.

## Switching TV inputs

Switch TV inputs to access the device connected to that input, for example, a Blu-ray™ player. Switching inputs is as easy as highlighting the input's tile in the Home screen, and pressing **OK**. The video signal on the input, if any, plays on the screen.

**Tip:** *To learn how to add, remove, rename, and rearrange the tiles on your Home screen, see [Customizing your TV](#).*

## Auto-detecting devices

Your TV automatically detects when you connect a new device to an **HDMI** input and turn on its power. The input is automatically added to the Home screen if it isn't already present.

## Adjusting audio/video settings

While watching video content on any input, press **STAR \*** to display the **TV settings** menu. Press **UP** or **DOWN** to highlight an option, and then press **LEFT** or **RIGHT** to change the setting. To learn about each of the audio and video settings, see [Adjusting TV settings](#).

## Setting preferred audio language for streaming channels

You can select the preferred language for the audio played by streaming channels. If the selected language is available in the streaming content, the TV plays that language.

To set the preferred audio language:

1. From the Home screen menu, navigate to **Settings > Audio > Audio preferred language**.
2. Press **RIGHT** to highlight one of the languages.
3. Press **UP** or **DOWN** to highlight the language you want to use.
4. Press **OK**.

**Note:** *Many streaming channels have an option to select the language while you are watching a program. The **Audio preferred language** setting sets the default for that option.*

## Automatic game console configuration

Your TV automatically detects select game consoles and configures the key features it supports to optimize TV performance while playing video games. When you connect a supported and powered-on game console through an HDMI® input, the TV automatically changes the input tile to the game console icon<sup>1</sup>. *Only on selected models with compatible game consoles*, it also enables:

- Automatic low-latency mode (ALLM)
- Variable refresh rate
- HDR gaming
- High frame rate
- Game mode
- THX Certified game mode

---

<sup>1</sup> Certain game consoles, such as the Microsoft Xbox One, do not communicate their identity until you select the input after connecting the console.

Various combinations of these features are available only on select Roku TV models, and if present, can be disabled by navigating to **Settings > TV inputs** and then selecting the appropriate HDMI input.

When you start playing a game, your TV displays a message at the bottom of the screen to make you aware of the settings that it will use.



Select **Cancel** before the timer runs out to keep the current TV picture settings. For example, you might want to cancel automatic configuration if you are watching a movie from your game console.

## Using Roku Voice commands

Roku Voice commands make it fast and easy to control your TV and find entertainment with simple voice commands like “show me comedies.” Control your TV with commands like “switch to game console,” or “watch channel 7.1.” Use your Roku Voice remote, the Roku mobile app, or a compatible smart speaker to speak commands. When using a smart speaker, add “on my Roku” or, for example, “on my *bedroom* Roku” to the end of the command.

To learn what commands to use, watch out for hints that appear at appropriate times. For example, if you are in the **TV settings** menu with the **Sleep timer** command highlighted, a hint might appear explaining how to use a Roku Voice command to set the sleep timer. You can use a Roku Voice command at any time, without first calling up a menu.

## Using Roku Voice remotes (select models only)

*Only on TVs with the Roku Voice remotes:* The following topics explain how to get the most out of your TV when it includes a Roku Voice Remote, Roku Enhanced Voice Remote, or Roku Voice Remote Pro.

### Re-pairing your Roku Voice remote

The Roku Voice remotes operate with wireless radio-frequency signals and must be paired with your TV. You initially paired the remote when you set up your TV during Guided Setup. But if your remote loses its pairing with the TV for some reason, you can easily re-pair it using either of the following methods:

1. Remove the battery cover from the back of the remote.
2. Press and hold down the pairing button for 3 seconds or longer, until the adjacent LED lights up.
3. Do one of the following:
  - Turn on the TV using the power button on the TV side or back panel. Pairing occurs as the TV starts up.
  - Use the Roku mobile app or a different remote to navigate to **Settings > Remotes & devices > Pair new device > Remote**.

**Tip:** *If the remote fails to pair with the TV, try installing new batteries. Also, it's helpful to hold the remote within two to three feet of the TV to ensure successful pairing.*

### Checking the Roku Voice remote battery level

You can check the condition of the batteries in your Roku Voice remote at any time by navigating to **Settings > Remotes & devices**, and then pressing **OK** to select your remote below **My paired devices**. With your remote selected, navigate right to **About > Remote** to view its **Battery level**. The resulting screen displays not only the battery level, but also other information that can be useful when you need technical support with your remote.

**Tip:** *When you first turn on the TV, a battery level indicator appears in the upper right corner of the screen for a few seconds.*

## Finding your Roku Enhanced Voice Remote or Roku Voice Remote Pro

*Only on TVs with the Roku Enhanced Voice Remote or Voice Remote Pro*, when your remote has found its way down into the sofa cushions or your dog has hidden it in the corner, you can use the Find Remote feature to find out where it's hiding. This feature has a limited range, and is designed to find your Enhanced Voice remote somewhere in the same room as the TV.

Select **Find Remote** on the **Settings > Remotes & devices > Remote settings** menu to see brief instructions on how to activate the Find Remote feature. Note, however, that selecting this option doesn't actually activate the feature. Here are the complete instructions:

### Activate Find Remote

- If your TV has a joystick-style control, press to the **Left** or **Right** to open the **Inputs** menu, and then press **Right** to scroll down to **Find Remote**.
- If your TV has a column of labeled panel buttons, press the **INPUT** button to open the **Inputs** menu, and then press the **INPUT** button again until you highlight **Find Remote**.

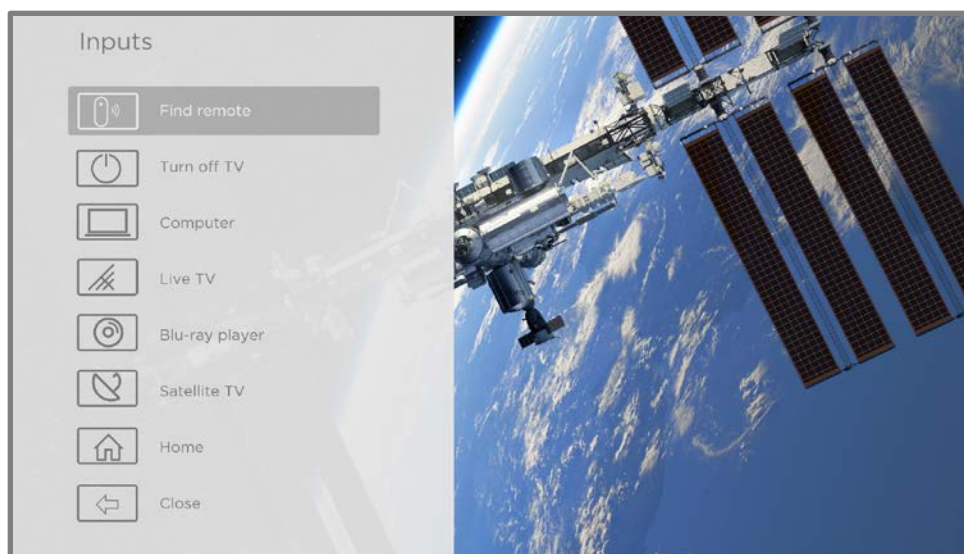

A moment or two after highlighting **Find Remote**, the remote starts playing your selected Find Remote sound to let you know where it is hiding. The sound automatically stops after a minute, or after you find the remote and press any button.

## Changing and previewing the remote finder sound

*Only on TVs with the Roku Enhanced Voice Remote or Voice Remote Pro, you can customize the sound your remote makes when you use the Find Remote feature. To customize the sound, navigate to **Settings > Remotes & devices > Remote settings > Change remote finder sound**. Select the sound you want to use from the available settings.*

To preview the sound you have chosen, select **Preview remote finder sound**, and then hold down **OK** on the remote to play the sound. When you release the **OK** button, the sound will stop.

## Playing content from USB storage devices

*Only in connected mode, your Home screen has the **Roku Media Player** tile. Otherwise, the Home screen has the **USB Media Player** tile. With either player, you can play personal music, video, and photo files from a personal USB flash drive or hard disk connected to the TV's USB port.*

To use this feature, make sure your media files are compatible with the Roku/USB Media Player. To see the latest list of supported formats, view **Help** in the Media Player<sup>1</sup>. The Roku/USB Media Player displays supported file types only, and hides file types it knows it cannot play.

**Note:** *If you do not see the Roku Media Player on your Home screen, it might have been uninstalled. You can reinstall it from the Roku Channel Store by using the **Channel Store** menu option or the **Add Channels** shortcut. The USB Media Player in non-connected mode cannot be uninstalled.*

For more information about playing back your personal videos, music, and photos, go to the following link on the Roku web site:

[go.roku.com/rokumediaplayer](http://go.roku.com/rokumediaplayer)

---

<sup>1</sup> There are many variants of each supported media format. Some variants may not play at all or may have issues or inconsistencies during playback.



## Auto player launch

*Only in connected mode*, you can set your TV to automatically open the Roku Media Player when you connect a USB drive with a recognizable file system (such as FAT16/32, NTFS, HFS+ or EXT2/3). To configure this setting, from the Home screen menu, navigate to **Settings > System > USB media**. At this point, the following options are available:

- **Auto-launch** – Select **Prompt**, **On**, or **Off**, as desired.
  - **Prompt** – (default) Display a prompt each time a recognized USB drive is connected. The prompt provides options to launch the Roku Media Player as well as to change future auto-play behavior.
  - **On** – Always launch the Roku Media Player whenever you connect a recognized USB drive.
  - **Off** – Never launch the Roku Media Player automatically.
- **Launch channel** – Select the app you want to use to play back media files.

## Playing content from local network media servers

*Only in connected mode*, your TV can play personal video, music, and photo files from a media server on your local network. Media servers include personal computers running media server software such as Plex or Windows Media Player, network file storage systems that have built-in media server software, and other devices that implement the specifications of the Digital Living Network Alliance. Some servers do not fully implement the DLNA specification but are UPNP (Universal Plug and Play) compatible. The Roku Media Player can connect to them as well.

Some media servers can convert files into Roku compatible formats. Digital Rights Management (DRM) protected content is not supported.

## Setting up a payment method

For Movie Store, TV Store, and other channels that allow you to pay through your linked Roku account, you can enter a payment method directly on your TV. Entering a payment method on your TV means that you don't need to go to a computer or mobile device to set up a payment method.

To add a payment method:

1. From the Home screen menu, navigate to **Settings > Payment method > Add payment method**.
2. Use the on-screen number pad to enter your credit/debit card number, expiration date, CVV number, and ZIP Code or postal code.

**Note:** *If you have already set up a payment method on my.roku.com, that payment method is identified here in such a way as not to expose any personal data. You can use this screen to change your payment method, if desired.*

3. Select **Save card**, and then press **OK**.

To manage your saved payment method and to see other payment methods, log into your account at [go.roku.com/pay](https://go.roku.com/pay).

## Using your TV in a hotel or dorm room

Hotels, school dorms, conference facilities, and similar locations with public wireless Internet access often require you to interact with a web page to authenticate your access. These types of networks are called *restricted public networks*. When you select a network of this type, the TV automatically detects that additional information is needed and prompts you through using another wireless device to supply the requested information.

## About using your TV on a restricted public network

Here are some points to keep in mind when using your TV on a restricted public network:

- Using your Roku TV on a hotel or dorm room network requires wireless availability and a network-connected smartphone, tablet, or computer to authenticate access to your wireless access point.
- You will need your Roku TV remote.
- Some content might be limited or unavailable if you try to connect outside your home country due to geo-filtering.

## Getting your Roku TV on line on a restricted public network

1. Either during Guided Setup or after using the **Settings > Network** menu to set up a new connection, the TV automatically detects that you are connecting to a restricted network and displays the following prompt:

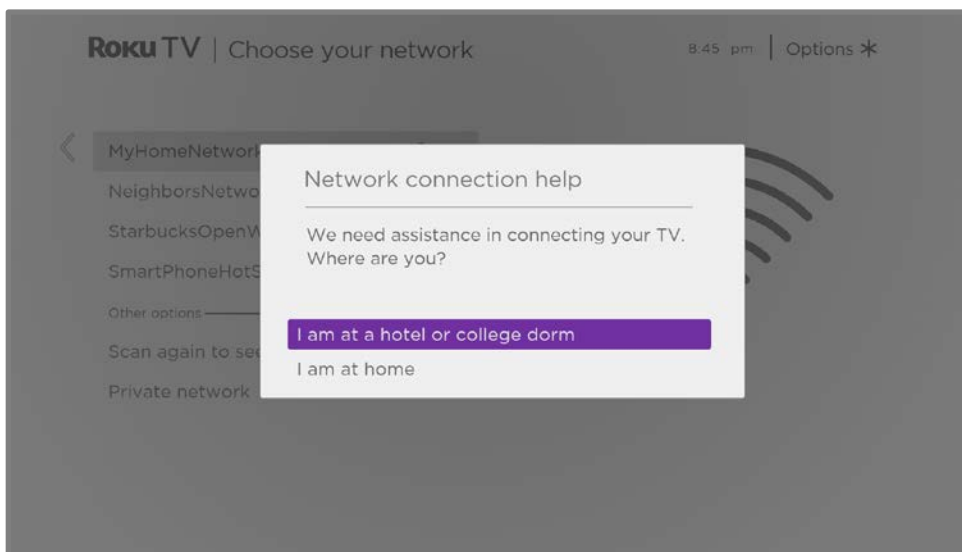

**Tip:** Your TV can connect to a restricted network only if **Enable 'Device connect'** is selected in **Settings > System > Advanced system settings**. (**Device connect** is enabled by default, but if you have disabled it, the TV cannot complete the connection.)

**Note:** **Device connect** is not present if the TV is in non-connected mode.

2. After selecting the correct network, highlight **I am at a hotel or college dorm**, and then press **OK**. The TV prompts you to use your smartphone, tablet, or laptop to complete the connection.

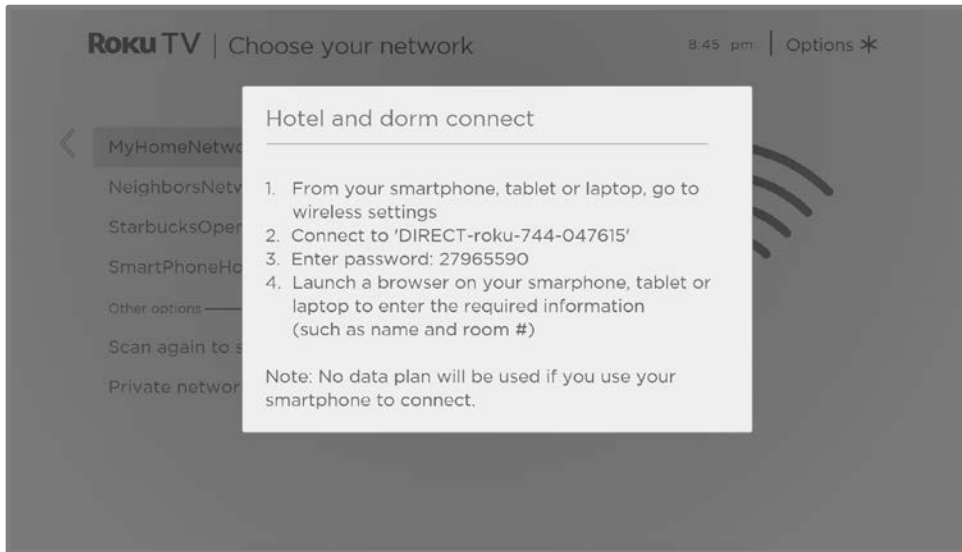

3. Use a mobile phone, tablet, or wireless-enabled computer to detect wireless networks. In most cases, you can simply open the device's Wi-Fi Settings or Network Settings screen to start scanning.

**Note:** *The mobile phone, tablet, or computer must be on the same wireless network to which you are connecting the TV.*

4. Connect to the network named on your TV screen. The actual network name varies.

**Note:** *The previous step connects your smartphone, tablet, or computer directly to the TV. No connection charges apply and the connection does not impact your device's data plan.*

5. The wireless connection process prompts you for a password. Enter the password as shown on the TV screen. The actual password varies.

6. Start the web browser on your mobile phone, tablet, or computer. When you attempt to open any web page, the restricted connection will prompt you for whatever information it needs. In most cases, you must agree to terms and conditions, provide identifying information, or enter a password, PIN, or room number to proceed. The information requested depends on the organization that controls the wireless connection.
7. After you enter the requested information, the TV automatically proceeds to complete its connection and resumes normal operation.
8. If the TV prompts you to link to your Roku account, use your mobile phone, tablet, or computer to activate your Roku TV.

# Using Apple AirPlay and the Apple Home app

## Apple AirPlay

AirPlay lets you share videos, photos, music, and more from your iPhone, iPad, or Mac. To use AirPlay, your Roku TV must be on the same wireless network as your Apple device<sup>1</sup>. To configure your preferred AirPlay security settings, navigate to **Settings > Apple AirPlay and HomeKit** from your Roku TV Home screen. Depending on the AirPlay settings you select, you may be required to enter a password on your Apple device to initiate an AirPlay session on your Roku TV.

## Other AirPlay things to try

- Screen mirroring from an iOS device.
- Screen mirroring from a Mac.
- Using your Roku TV as an extended Mac display.
- Playing synchronized music on multiple AirPlay 2-enabled devices, including Roku TVs.

## Apple Home app

Apple HomeKit controls compatible smart home lights, locks, thermostats, and other devices, including Roku TVs. The Apple Home app lets you add your Roku TV to your Apple HomeKit ecosystem. You can also interact with HomeKit-enabled devices by using Siri from your iPhone, iPad, Apple Watch, HomePod or Mac.

To enable your Roku TV to work with the Apple Home app

---

<sup>1</sup> iPhone, iPad, or iPod touch with iOS 12.3 or later. Mac with macOS Mojave 10.14.5 or later.

1. From your TV's Home screen, navigate to **Settings > Apple AirPlay and HomeKit**.
2. Under **HomeKit**, select **Set Up**. Your TV will display a unique QR code.
3. From your Apple device, open the Apple Home app and select **Add Accessory**.
4. Use the Apple Home app to scan the QR code displayed on your TV and follow the instructions.

## Some Apple HomeKit things to try

On your Apple device, say:

- “Hey Siri, play jazz in the living room.”
- “Hey Siri, mute the TV in the office.”
- “Hey Siri, turn off the TVs in my home.”
- Add your Roku TV to an Apple Home scene.

Find more ideas at <https://www.apple.com/ios/home/>.

# Adjusting TV settings

You can adjust most picture and sound settings while you are watching a program by pressing **STAR \*** to open the **TV settings** menu. There are some additional picture and sound settings in the main **Settings** menu.

In most cases, the changes you make apply only to the input you are using. Live TV, each HDMI® input, and the AV input have their own settings that the TV remembers when you return to that input. The TV also separately remembers the settings you specify while viewing streaming content.

## Main Settings menu

Use the main **Settings** menu to adjust overall TV settings. Press **HOME**  to go to the Home screen, and then navigate to **Settings > TV picture settings**.

You can adjust the following overall TV picture settings from the **Settings screen**:

- **TV brightness** – Provide a better viewing experience in darker or brighter rooms. Increases or decreases the TV's general brightness across all TV inputs.

**Note:** *This setting is identical to the **TV brightness** setting you can access in the **TV settings** menu while watching a program.*

- **HDR/Dolby Vision notification** – *Only on select models:* Controls whether the TV displays a notification in the upper right corner of the screen for a few seconds when HDR or Dolby Vision™ content begins to play.
  - **On** – The TV displays a notification when HDR or Dolby Vision™ content begins to play.
  - **Off** – The TV does not display a notification when HDR or Dolby Vision™ content begins to play.



**Note:** *This setting does not affect the HDR or Dolby Vision™ notification that always appears in the program information banner. Press **OK** while watching a program to open the program information banner.*

- **Settings per input** – Lists each enabled TV input. Select an input, and then press **STAR \*** to display the **TV settings** menu where you can adjust the input's settings while watching the video and listening to the sound from that input.

**Tip:** *You don't have to go to the main **Settings** menu first—you can display an input's **TV settings** menu and adjust its settings whenever you are watching the input by pressing **STAR \***.*

## TV settings menu

The **TV settings** menu provides settings for controlling the appearance of the picture and the quality of the audio for each TV input. To view the **TV settings** menu, press **STAR \*** whenever you are watching a TV input or streaming a video.

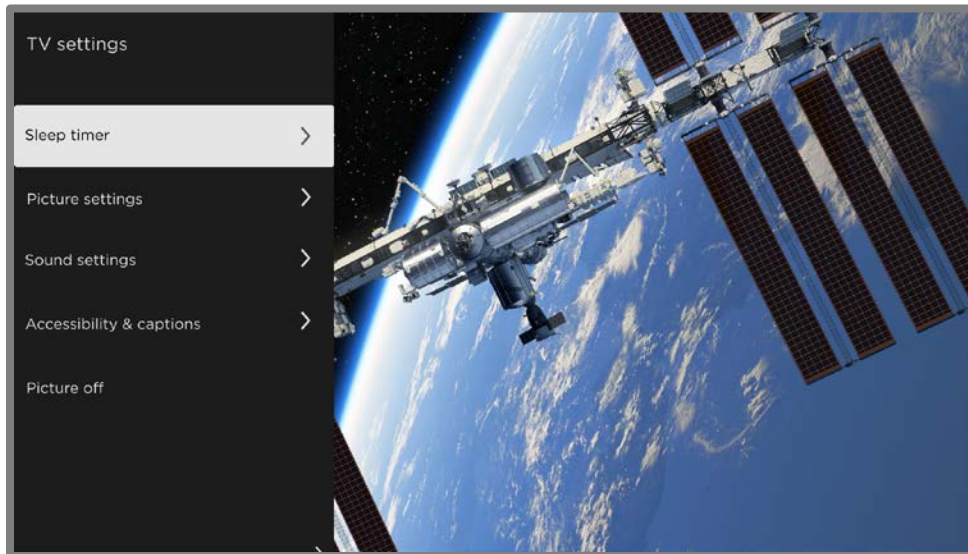

### TV settings menu

**Tip:** *Some streaming channels assign **STAR \*** to a different function (or no function at all), meaning this button will not open the **TV settings** menu. In these cases, use a different channel, such as The Roku Channel, to configure options. The selected settings remain active for all streaming channels.*

Press **UP** or **DOWN** to highlight a setting, and then press **OK** or **RIGHT** to see the options for the setting. You'll see the changes you make right away in picture appearance or audio quality.

- [Sleep timer](#)
- [Picture settings](#)
- [Sound settings](#)
- [Manage channels \(U.S., connected mode\)](#)
- [Manage channels \(Canada/non-connected mode\)](#)
- [Accessibility & captions](#)
- [Picture off](#)

**Tip:** To dismiss the **TV settings** menu, just wait a few seconds without pressing any buttons. Or press **STAR \*** again to dismiss the menu immediately.

## Sleep timer

Opens the **Sleep timer** menu where you can set a timer that turns off the TV after the specific amount of time. *This setting remains in effect even if you stop watching the current input.*

## Picture settings

The **Picture settings** menu adjusts the appearance of the picture for the active input.

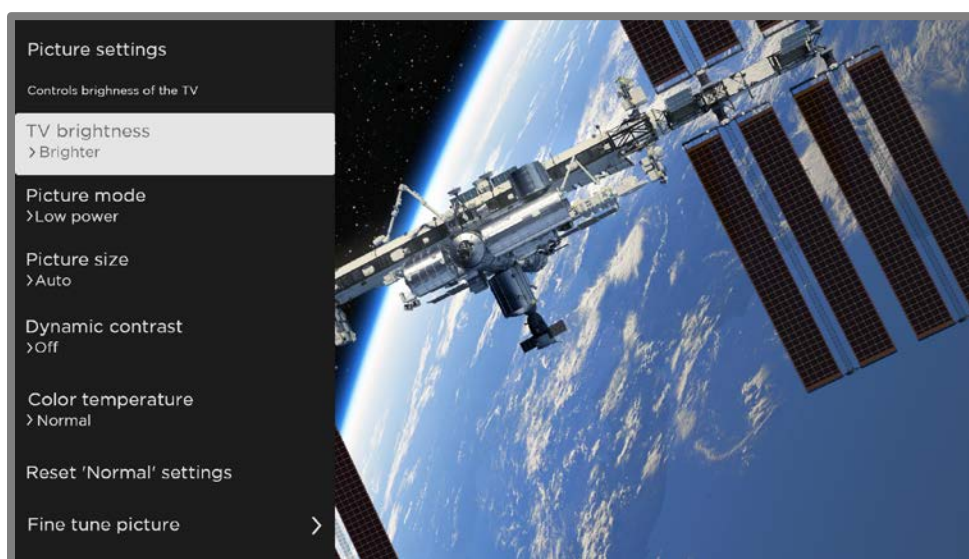

## Typical **Picture settings** menu

- **TV brightness** – Overall brightness of the picture. *This setting applies to all TV inputs and is identical to the **TV brightness** setting under **Settings > TV picture settings**.*
- **Picture mode** – Picture presets for various viewing preferences. For example, selecting **Vivid** sets **Brightness, Contrast, Sharpness**, and other values to produce a very vibrant picture. Selecting **Movie** changes the settings to produce a picture suitable for enjoying movies in a darkened room.

**Tip:** *If you make changes to individual picture settings, these settings are saved for the current input and the current **Picture mode**. In this way, you can individually set the HDMI 1 input's **Movie** picture mode to use different settings than the HDMI 2 input's **Movie** picture mode, and different settings than the Live TV input's **Movie** picture mode.*

**Note:** *If you change the settings of a **Picture mode**, a small purple dot appears to the right of the **Picture mode** name.*

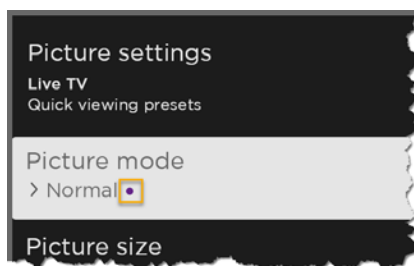

Use **Reset picture settings**, described below, to return the input's selected picture mode to its default settings.

- **Picture size** – Aspect ratio of the picture, enabling you to view a picture in its original format, or zoom or stretch it to fill the screen. The **Auto** setting has been found to produce the best picture in most cases.

**Note:** *Certain picture settings vary by brand and model. Not all settings are available on all TVs. Names of certain settings also vary by brand and might differ from the names listed here.*

- **Local dimming** – *Only on select models:* Sets the amount of dimming applied to multiple areas of the screen’s backlight intensity. This setting can make dark areas darker without affecting the brightness of light areas.
- **Dynamic contrast** – *Only on select models:* Automatically adjusts the backlight level to achieve the optimum contrast and prevent excessive differences between light and dark areas of the screen.
- **Micro contrast** – *Only on select models:* Improves image contrast.
- **Action Smoothing** – *Only on select models. Each TV brand uses a different name for this option.* Adjusts the amount of motion processing applied to the video signal. A higher setting results in more smoothing, but can cause undesirable picture artifacts in certain types of content. Each **Picture mode** has a different default setting.
- **Natural Cinema** – *Only on select models. Each TV brand uses a different name for this option.* When enabled, this feature reduces “judder” that is often present when 24 frame-per-second movies are upscaled to 60Hz TV standards. **Natural Cinema** mode is **On** by default in **Movie** and **HDR Dark** picture modes, and **Off** by default in other picture modes.
- **Action Clarity** – *Only on select 120Hz models. Each TV brand uses a different name for this option.* Reduces blur, especially for fast-moving images such as sports.
- **LED Motion Clarity** – *Only on select models that also have the local dimming feature. Each TV brand uses a different name for this option.* Reduces motion blur caused by the refresh rate of the screen. Enabling this feature inserts black frames between picture frames in a way that improves the clarity of fast moving objects. It provides an improved viewing experience for video games and sporting events, but reduces the brightness of the picture. You can select settings of **Low**, **Medium**, **High**, or **Off** to achieve the desired picture quality.
- **Game mode** – *Only on HDMI® and AV inputs:* Controls whether Game mode is enabled. When **On**, the TV performs less image processing and has less input lag. When **Off**, the TV performs more image processing and has more input lag, which is less desirable for action games. Also see [Variable refresh rate \(VRR\)](#).

- **Auto low latency mode (ALLM)** – *Only on select models:* Auto Low Latency Mode (ALLM) detects when certain game consoles are connected to an **HDMI** input, and then automatically configures the best settings for action games when that input is selected. When ALLM is active, the manual **Game mode** setting is not available. *The TV does not display an **ALLM** menu option.*
- **Color temperature** – Adjusts the overall color tones in the picture from **Normal** to slightly more bluish (**Cool**) to slightly more reddish (**Warm**).
- **Reset picture settings** – Returns all picture settings for the input's currently-selected **Picture mode** to their original values.
- **Apply settings to all inputs** – Applies the settings of the current **Picture mode** to all TV inputs.
- **Fine tune picture** – Displays the **Fine tune picture** menu.

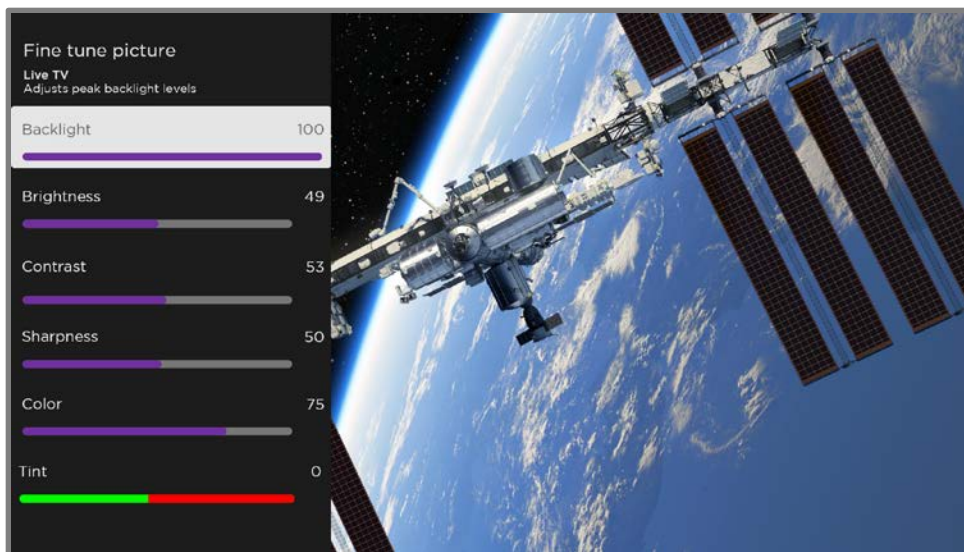

Fine tune picture menu

## Fine tune picture menu options

- **Backlight** - Adjusts the overall light intensity of the screen.
- **Brightness** - Adjusts the dark level of the picture.
- **Contrast** - Adjusts the white level of the picture.
- **Sharpness** - Adjusts the sharpness of edges in the picture.

- **Color** – Adjusts the saturation of colors in the picture. A setting of 0 removes all color and displays a black and white picture.
- **Tint** – Adjusts the color balance from green to red to obtain accurate colors in the picture.

## Variable refresh rate (VRR)

*Only on select models:* Variable refresh rate (VRR) allows a compatible game console or computer connected via HDMI to control the refresh rate of the TV. This feature helps to ensure that the TV does not begin to display a video frame until the video source has completely rendered it. The result is smoother image animation with a lower instance of stutter or tearing. This feature requires the following conditions:

- **Variable refresh rate** is turned **On** in the HDMI settings for the input. This setting is **Off** by default.
- The **HDMI mode** is set to **Auto** or **HDMI 2.0** in the HDMI settings for the input.
- **Game mode** is enabled.
- The connected device supports VRR.

## Expert Picture Settings (4K models only)

4K (UHD) TV models have additional picture settings for demanding home theater enthusiasts. Expert Picture Settings include gamma, noise reduction, 11-point white balance adjustment, and extended color space management.

You can access Expert Picture Settings only by using the Roku mobile app on an iOS® or Android™ mobile device. For more information, go to the following link on the Roku web site:

[go.roku.com/expertpicturesettings](https://go.roku.com/expertpicturesettings)

# Sound settings

Your TV model might have any one of the following premium sound settings available in the **TV settings** menu:

- No Sound settings
- [Roku premium audio devices](#)
- [Volume mode](#)
- [Dolby® Audio Processing](#)
- [DTS® TruSurround](#)
- [DTS® Studio Sound](#)
- [Sonic Emotion™ Premium](#)

## Roku premium audio devices

You can purchase and connect a Roku premium audio device, such as a Roku Streambar™, to the **HDMI ARC** or **HDMI eARC** port on any model of Roku TV. When you do, you can put away the remote control for that device, because the **Sound settings** menu on the TV provides direct access to the sound settings of the connected Roku device. These settings replace the sound settings that might be available when the Roku premium audio device is not connected.

To access Roku premium audio settings, first press **STAR \*** to display the **TV settings** menu, then select **Sound settings**.

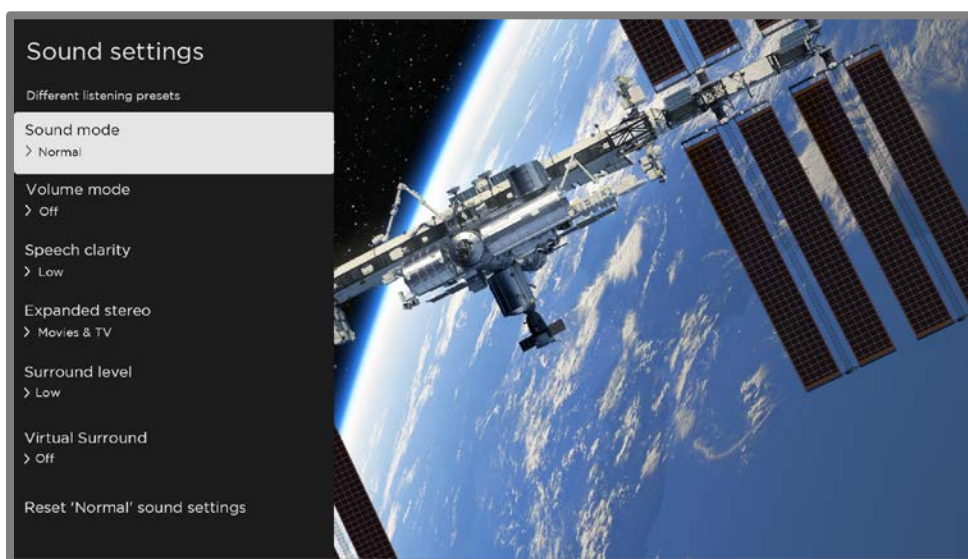

**Sound settings** menu for Roku premium audio devices

## Sound settings menu – Roku premium audio

- **Sound mode** – Select from among various preset sound modes to make shows and music sound their best. *This setting applies across the entire TV; that is, to all TV inputs.*
- **Volume mode** – Select from among modes for normal listening, volume leveling, and night listening.
- **Speech clarity** – Select **Off**, **Low**, or **High** to make voices easier to hear above the rest of the program.
- **Expanded stereo** – Select one of the available settings to simulate surround sound or, *only with Roku wireless speakers in a 3.x or 5.x surround configuration*, to play stereo sound from all speakers.
- **Surround level** – *Only if you have Roku wireless speakers in a 3.x or 5.x surround configuration*, this option lets you select the surround volume level to your liking.
- **Virtual surround** – *When you do not have Roku wireless speakers in a surround configuration*, this option enhances the stereo sound from the soundbar to simulate surround sound.
- **Dolby AC-4 Dialog Enhancement** – *Only on select models:* Select **On for AC-4** to enhance the dialog in content that supports the AC-4 audio format.
- **Reset sound settings** – Returns all sound settings to their defaults.



## Volume mode (select models only)

To access Volume mode, first press **STAR \*** to display the **TV settings** menu, then select **Sound settings**.

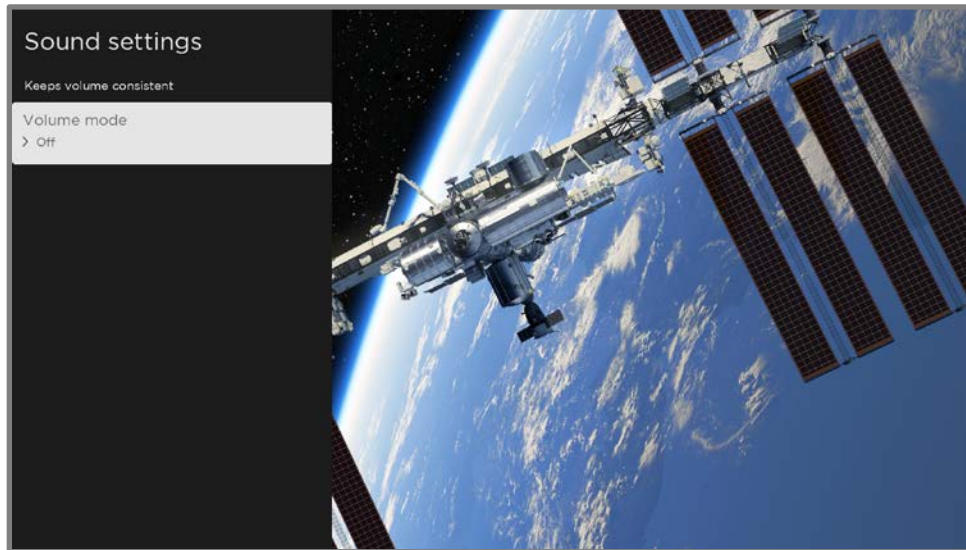

**Sound settings** menu for models with Volume mode

**Tip:** Some streaming channels assign **STAR \*** to a different function, meaning it will not open the **TV settings** menu. In these cases, use a different channel, such as The Roku Channel, to set the Volume mode. The selected mode remains active for all streaming channels.

### Sound settings menu - Volume mode

- **Volume mode**
  - **Off** – Volume mode is inactive and content volume is unmodified.
  - **Leveling** – Provides a consistent volume level across different types of content, so that you need not change the volume every time you switch channels or when a commercial comes on.
  - **Night** – Soft sounds, such as whispers, are increased while loud sounds, such as explosions, are decreased, making it easier to hear your TV at night without disturbing others.
  - **Dolby AC-4 Dialog Enhancement** – *Only on select models:* Select **On for AC-4** to enhance the dialog in content that supports the AC-4 audio format.

## Sound settings – Dolby® Audio Processing (select models only)

Each TV input has separate settings for fine tuning sound quality. All of the settings in this menu apply only to the currently-selected input. To access the DAP settings, first press **STAR \*** to display the **TV settings** menu, then select **Sound settings**.

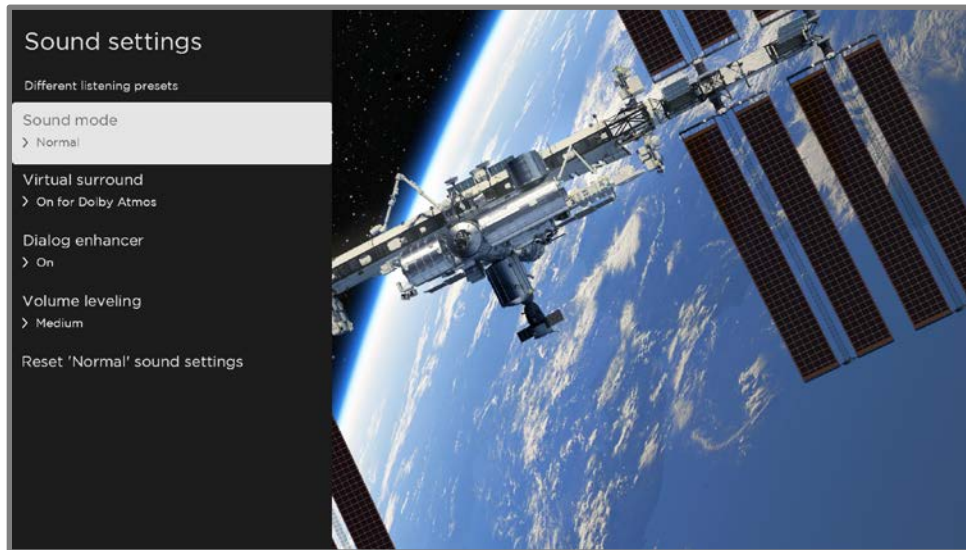

**Sound settings** menu for models with Dolby® Audio Processing

**Tip:** Some streaming channels assign **STAR \*** to a different function, meaning it will not open the **TV settings** menu. In these cases, use a different channel, such as The Roku Channel, to configure Dolby® Audio Processing. The selected settings remain active for all streaming channels.

### Sound settings menu- Dolby® Audio Processing

- **Sound mode** – Select from among various preset sound modes to improve speech, make music sound its best, boost bass or treble, or simulate a theater. Use **Reset sound settings**, described below, to return the input's current settings to their original values. *This setting applies across the entire TV; that is, to all TV inputs.* It does not affect the sound quality for headphones, **HDMI (ARC) HDMI (eARC)**, or **S/PDIF (TOSLINK)** connectors.
- **Virtual surround** (*Only on select models*) – Options vary by TV model. Simulates surround sound that otherwise would require installation of a surround sound audio system. Sometimes, the effect interferes with dialog clarity. Use the **Dialog enhancer** option to compensate.
- **Dialog enhancer** – Improves the clarity of speech when on.

- **Volume leveling** - Smooths out the high and low sounds.
- **Dolby AC-4 Dialog Enhancement** - *Only on select models:* Select **On for AC-4** to enhance the dialog in content that supports the AC-4 audio format.
- **Reset sound settings** - Returns **Virtual surround**, **Dialog enhancer**, and **Volume leveling** settings to their default settings for the selected **Sound mode**.

## Sound settings – DTS® TruSurround / DTS® Studio Sound (select models only)

Each TV input has separate settings for fine tuning sound quality. All of the settings in this menu apply only to the currently-selected input. To access the DTS® settings, first press **STAR \*** to display the **TV settings** menu, then select **Sound settings**.

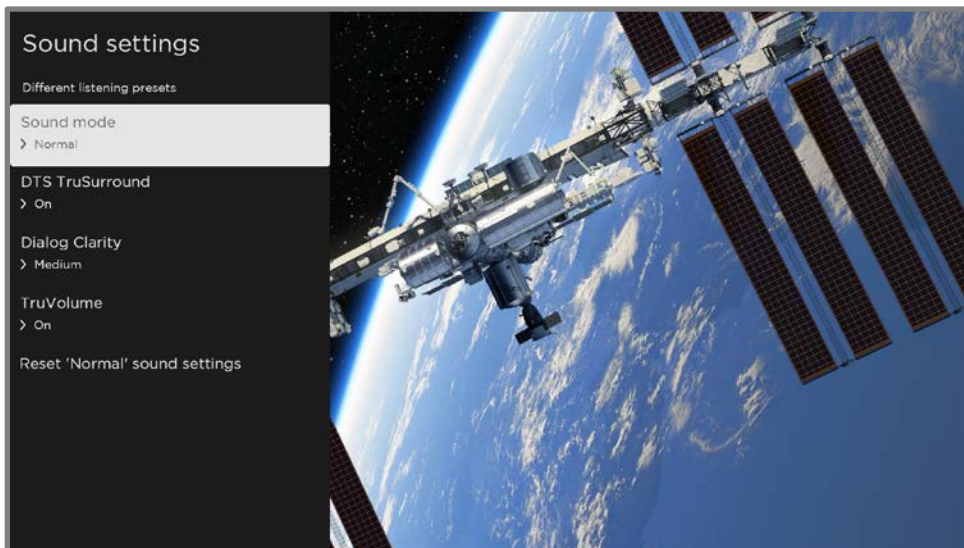

**Sound settings** menu for models with DTS® TruSurround/Studio Sound

**Tip:** *Some streaming channels assign **STAR \*** to a different function, meaning it will not open the **TV settings** menu. In these cases, use a different channel, such as The Roku Channel, to configure DTS® Studio Sound. The selected settings remain active for all streaming channels.*

## Sound settings menu- DTS® TruSurround / DTS® Studio Sound

- **Sound mode** – Select from among various preset sound modes to improve speech, make music sound its best, boost bass or treble, or simulate a theater. Use **Reset audio settings**, described below, to return the input's current settings to their original values. *This setting applies across the entire TV; that is, to all TV inputs.* It does not affect the sound quality for headphones, **HDMI (ARC) HDMI (eARC)**, or **S/PDIF** (TOSLINK) connectors.
- **DTS TruSurround** –Simulates surround sound that otherwise would require installation of a surround sound audio system. Sometimes, the effect interferes with dialog clarity. Use the **Dialog clarity** option to compensate.
- **Dialog Clarity** – Available only when **DTS TruSurround** is **On**. Choose among **Low**, **Medium**, and **High** settings to improve the clarity of dialog when you are using the TruSurround feature.
- **TruVolume** – Minimizes annoying volume fluctuations in programs.
- **Dolby AC-4 Dialog Enhancement** – *Only on select models:* Select **On for AC-4** to enhance the dialog in content that supports the AC-4 audio format.
- **Reset sound settings** – Returns **DTS TruSurround**, **Dialog Clarity**, and **TruVolume** settings, to their default settings for the selected **Sound mode**.

## Sound settings – Sonic Emotion™ Premium (select models only)

Sonic Emotion™ Premium is an audio technology that enables your TV to produce a more immersive sound experience. Each TV input has separate settings for fine tuning sound quality. All of the settings in this menu apply only to the currently-selected input. To access the Sonic Emotion™ settings, first press **STAR \*** to display the **TV settings** menu, then select **Sound settings**.

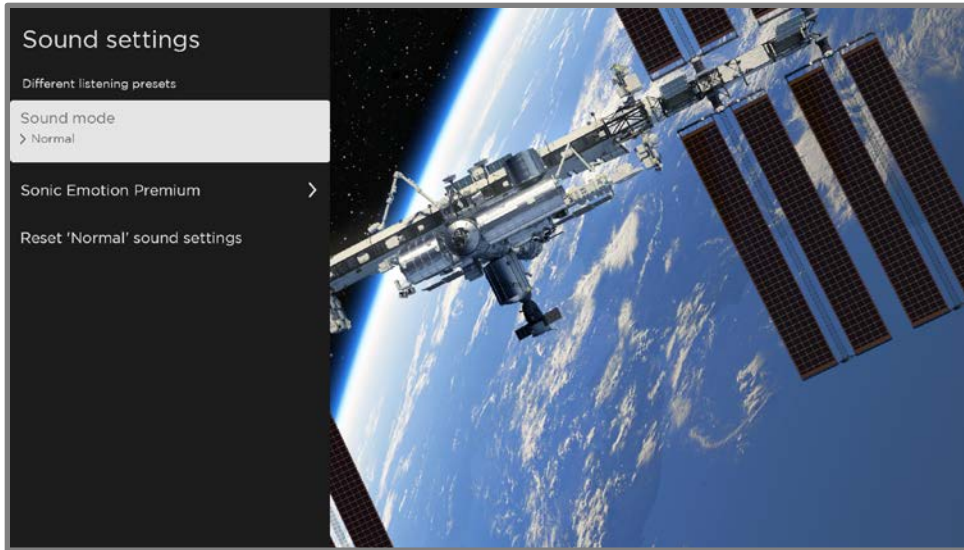

### Sound settings menu for models with Sonic Emotion™ Premium

**Tip:** Some streaming channels assign **STAR \*** to a different function, meaning it will not open the **TV settings** menu. In these cases, use a different channel, such as The Roku Channel, to configure Sonic Emotion™. The selected settings remain active for all streaming channels.

### Sound settings menu- Sonic Emotion™ Premium

- **Sound mode** – Select from among various preset sound modes to improve speech, make music sound its best, boost bass or treble, or simulate a theater. Use **Reset audio settings**, described below, to return the input's current settings to their original values. *This setting applies across the entire TV; that is, to all TV inputs.* It does not affect the sound quality for headphones, **HDMI (ARC) HDMI (eARC)**, or **S/PDIF (TOSLINK)** connectors.
- **Sonic Emotion Premium** – Displays a menu with individual Sonic Emotion™ audio settings, as described in [Sonic Emotion™ settings](#).
- **Dolby AC-4 Dialog Enhancement** – *Only on select models:* Select **On for AC-4** to enhance the dialog in content that supports the AC-4 audio format.
- **Reset sound settings** – Returns **Sonic emotion** settings to their default settings for the selected **Sound mode**.

## Sonic Emotion™ settings

When you select **Sonic Emotion Premium** from the **Sound settings** menu, these additional settings become available:

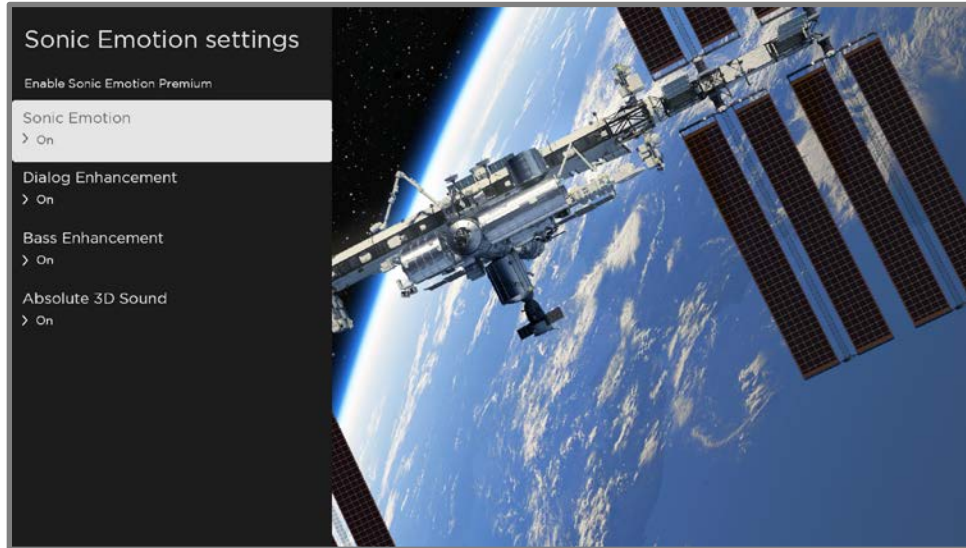

**Sonic Emotion settings** menu for models with Sonic Emotion™ Premium

- **Dialog Enhancement** – Enhances your ability to hear and understand dialog in the program.
- **Bass Enhancement** – Enhances the low frequency sound component in the program.
- **Absolute 3D Sound** – Simulates sound from multiple speakers that would otherwise require installation of a surround sound audio system.

## Manage channels (U.S., connected mode)

*Only in the United States in connected mode, you can designate favorite channels and edit your channel lineup in the **Manage Channels** menu. To manage channels in Canada or in non-connected mode, see [Manage channels \(Canada/non-connected mode\)](#). You can navigate to the **Manage Channels** menu in several ways:*

- From the Home screen menu, navigate to **Settings > TV inputs > Live TV > Manage channels**, and then select **Manage all channels** and press **OK**.
- While watching a live TV program, press **STAR \*** to display the **TV settings** menu, and then navigate to **Manage channels** and press **OK**.
- While using the Live TV Channel Guide, navigate all the way to the left to the channel column, and then press **STAR \***. In the **Channel options** dialog, highlight **Manage channels** and press **OK**.

Next, in the **Manage Channels** menu, select **Favorite channels** or **Edit channel lineup**.

## Favorite channels (U.S., connected mode)

To designate favorite channels in Canada or in non-connected mode, instead see [Favorite channels \(Canada/non-connected mode\)](#).

*Only in the United States in connected mode, use the **Favorite channels** menu to designate any number of channels as your favorites.*

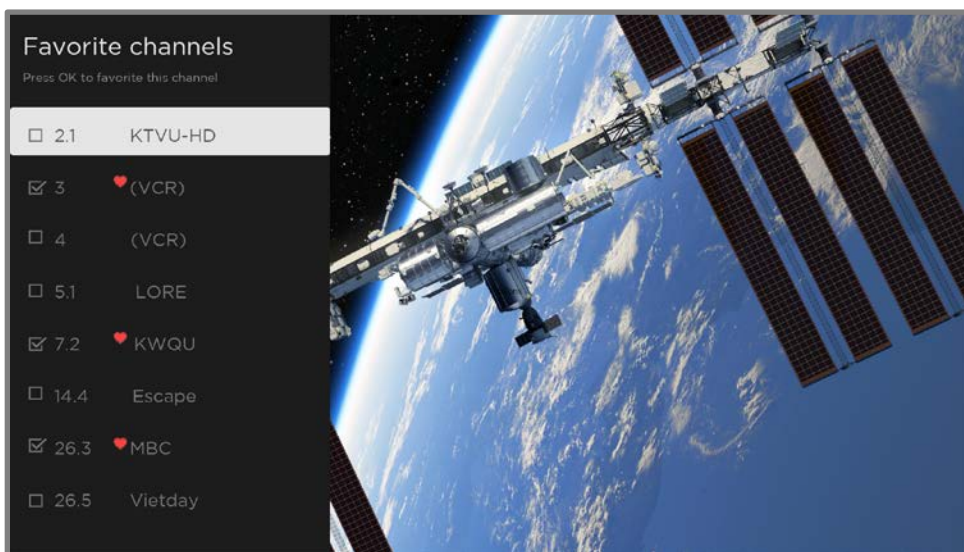

Press **UP** or **DOWN** to highlight a channel, and then press **OK** to select or clear its check box. A **FAVORITE**  symbol appears next to each channel you designate as a favorite.

**Tip:** *Pause for a few seconds for the TV to tune to the highlighted channel. You then can view and hear the channel to decide whether you want to make it a favorite. If you've enabled parental controls and the program on the current channel is blocked, you won't see a picture or hear sound while using the **Favorite channels** menu.*

To switch between surfing all channels and favorite channels, use the **Filter** option in the **Channel options** dialog, as explained in [Changing channel options in connected mode \(U.S. only\)](#).

## Edit live TV channel lineup (U.S., connected mode)

To edit your channel lineup in Canada or in non-connected mode, instead see [Edit live TV channel lineup \(Canada/non-connected mode\)](#).

*Only in the United States in connected mode,* when you scan for channels described in [Setting up live TV](#), the TV adds all the channels with good signals that it can detect in your area. In addition, unless you hide them as explained in [Hide streaming TV channels \(U.S. only\)](#), the channel lineup will include streaming channels in addition to your local TV stations.

At this point, you might have more channels than you want in your channel list. Use the **Edit channel lineup** menu to hide any channels that you do not want in your channel list.



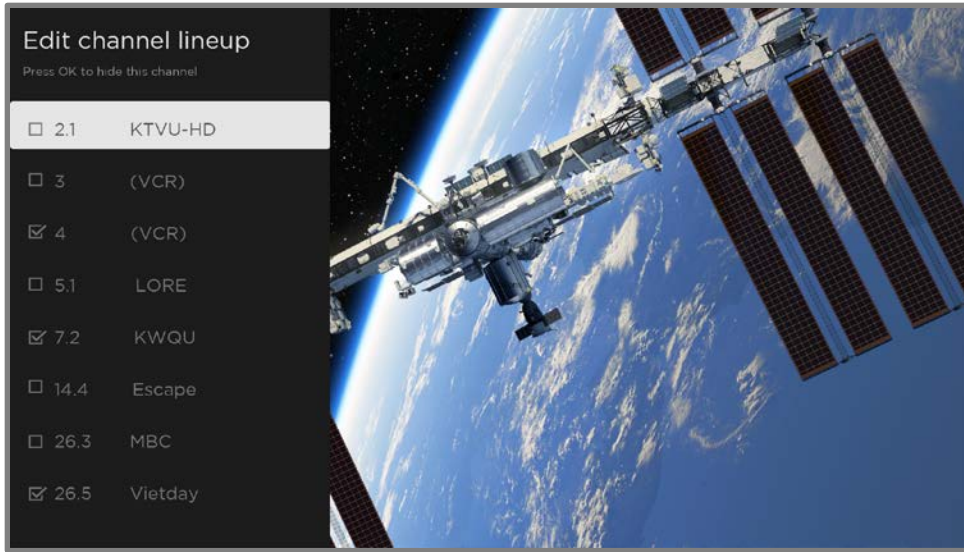

Press **UP** or **DOWN** to highlight a channel, and then press **OK** to select or clear its check box. Channels with check marks are hidden in the Live TV Channel Guide and cannot be tuned.

**Tip:** *Pause for a few seconds for the TV to tune to the highlighted channel. You then can view and hear the channel to decide whether you want to hide it. If you've enabled parental controls and the program on the current channel is blocked, you won't see a picture or hear sound while using the **Edit channel lineup** menu.*

To switch between surfing all channels and favorite channels, use the **Filter** option in the **Channel options** dialog, as explained in [Changing channel options](#).

## Hide all streaming TV channels (U.S., connected mode)

*Only in the United States in connected mode*, by default, the Live TV Channel Guide shows both antenna channels and streaming channels in one long list. If you prefer, you can hide all streaming channels from the Live TV Channel Guide.

To hide streaming TV channels, from the Home screen menu, navigate to **Settings > TV inputs > Live TV > Manage channels**, and then highlight **Hide all streaming TV channels** and press **OK** to select the adjacent check box.

## Manage channels (Canada/non-connected mode)

To manage channels in the U.S in connected mode, see [Manage channels \(U.S., connected mode\)](#).

*In Canada, or in non-connected mode in the United States, the **TV settings** menu does not have a **Manage channels** option. Instead, you can designate favorite channels and edit your channel lineup as explained in this topic.*

## Favorite channels (Canada/non-connected mode)

Use the channel list to designate any number of channels as your favorites and to change from surfing among all channels or only your favorite channels.

1. While watching live TV, Press **LEFT** to display the channel list. Notice that the words **All channels** appear at the top of the channel list.
2. Scroll up or down to highlight a channel that you want to make a favorite.
3. Press **STAR \***, and then press **OK** to select **Add to favorites**. If the channel is already one of your favorites, press **OK** to select **Remove from favorites**. A **FAVORITE** symbol  appears next to each channel you designate as a favorite.

## Surf only favorite channels (Canada/non-connected mode)

After you've marked one or more channels as favorites, you can switch to your favorite channels.

1. While watching live TV, press **LEFT** to display the channel list.
2. Press **LEFT** or **RIGHT** once to switch to **Favorites**. Notice that the word **Favorites** appears at the top of the channel list.
3. Highlight a channel and press **OK** to select a channel or wait a few moments until the channel list disappears.
4. Press **UP** or **DOWN** to change to the previous or next favorite channel. Channel surfing is limited to favorite channels only.

**Note:** Favorite channels remain in effect even if you turn off or unplug your TV, until you switch back to all channels. To surf all channels again, repeat these steps, but this time select **All Channels**.

When you press **OK** to view the program information banner while watching a favorite channel, a **FAVORITE** ❤️ symbol appears next to the channel call sign.

## Edit live TV channel lineup (Canada/non-connected mode)

When you scan for channels described in [Setting up live TV](#), the TV adds all the channels with good signals that it can detect in your area. It is likely that you now have more channels than you want in your channel list.

To edit the channel lineup in Canada or in non-connected mode in the United States, from the Home screen menu, navigate to **Settings > TV inputs > Live TV** and then select **Edit channel lineup**. You'll see a screen listing all of your channels. Adjacent to the list of channels is a miniature TV screen playing the highlighted channel's picture and sound.

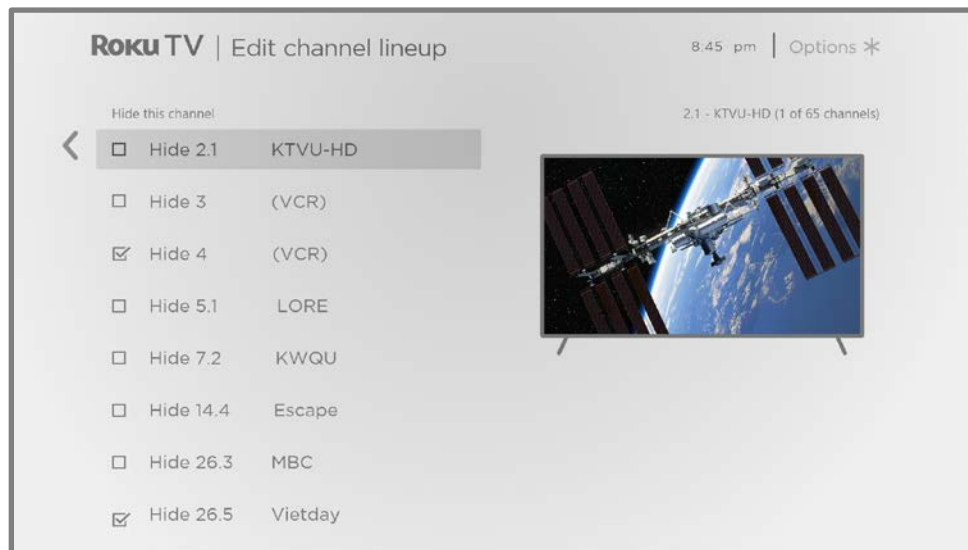

For each channel you want to hide, highlight it, and then press **OK** to select its check box.

**Tip:** *If you need to view the highlighted channel to decide whether to hide it, wait a couple of seconds for the TV to start playing the channel's picture and sound. If you've enabled parental controls and the program on the current channel is blocked, you won't see a picture or hear sound while editing the channel lineup.*

**Note:** *Repeating the live TV channel scan unhides all hidden channels.*

## Accessibility & captions

The settings on the **Accessibility & captions** menu enable you to change the TV's accessibility settings without leaving the program you are watching. These settings are also available on the **Home** screen menu under **Settings > Accessibility**.

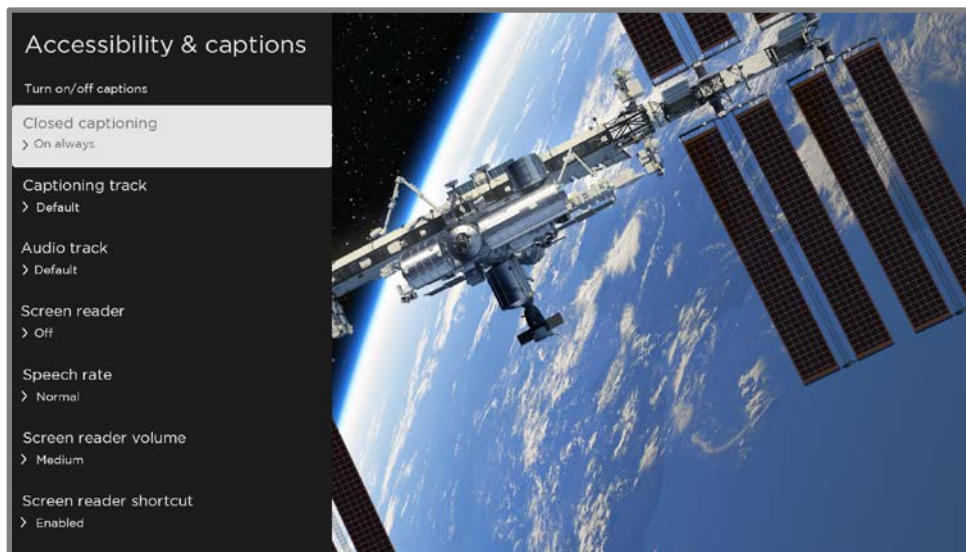

**Accessibility & captions** menu (U.S version)

**Tip:** *Some streaming channels assign **STAR \*** to a different function, meaning it will not open the **TV settings** menu. In these cases, use a different channel, such as The Roku Channel, to configure accessibility options.*

## Accessibility & captions menu settings

- **Closed captioning** – Controls when you see captions. *This setting is only offered for the **ANT** and **AV** inputs, and streaming/media player videos. Any set value remains in effect across only these inputs.*
- **Live TV** – Set captions to off, always on, on only when the TV sound is muted, or on only during instant replay (when Live TV Pause has been enabled).
- **AV input** – Set captions to off, always on, or on only when the TV sound is muted.
- **Streaming video channel or media player** – For streaming content that provides closed captions, set captions to off, always on, on only when the TV sound is muted, or on only during instant replay (for streaming content that supports instant replay). Note that some streaming channels have other methods for turning captions on and off. In these cases, the **Closed captioning** option does not appear on the **TV settings** menu.

**Note:** If **REPLAY**  is not available on your remote, you can use this feature in the Roku mobile app. For more information, see [Roku mobile app](#).

- **Captioning track** – Selects which caption track to display when closed captioning is on. *This setting remains in effect on all inputs that provide captions.*
- **SAP** – Select whether to play a secondary audio program or multichannel television sound, and which choice to play. See [Video description through Secondary Audio Program \(SAP\)](#). *This setting applies only to live TV on digital channels.*
- **Audio track** – Select the audio track to play with the current program. *This setting applies only to streaming content when multiple audio tracks are available.*
- **Screen reader** – *Only in the United States*, turn the screen reader on or off. The screen reader is a text-to-speech user interface to help you navigate the Roku

user interface and on-screen menus. When enabled, it reads out text, menus, and other on-screen items.

**Accessibility:** *If **Screen reader shortcut** is enabled, you can enable or disable the screen reader by pressing the **STAR \*** four times in quick succession. (**STAR \*** is located directly below the purple directional pad on the right side of the Roku remote.)*

- **Speech rate** – *Only in the United States*, select the speed at which the screen reader speaks.
- **Screen reader volume** – *Only in the United States*, set the volume of the screen reader in relation to the main TV volume.
- **Screen reader shortcut** – *Only in the United States*, enable or disable the screen reader shortcut feature. When disabled, pressing **STAR \*** four times in quick succession does not enable or disable the screen reader.

## Video description through Secondary Audio Program (SAP)

Video description of the action in a program helps individuals who are blind or visually impaired enjoy programs. You enable video description by selecting one of the Secondary Audio Program (SAP) options.

To hear video description narrations in programs that have them, turn on **SAP**. If there are multiple **SAP** options for a channel, such as **Spanish** and **French**, try each one to determine which setting carries the video description track.

**Accessibility:** *Broadcasters provide video descriptions only on a small number of programs. If you are unable to hear video descriptions after following these instructions, the program you are viewing does not provide them.*

For more details about video description, go to:

United States: <https://www.fcc.gov/consumers/guides/audio-description>

Canada: [https://crtc.gc.ca/eng/info\\_sht/b322.htm](https://crtc.gc.ca/eng/info_sht/b322.htm)

## Picture off

Select **Picture off** to turn off the screen while continuing to play the sound. You might want to use this feature when listening to music or podcasts, or at any other time that you do not want to see the TV screen.

When you want to turn the picture back on, press **OK**. Or, if you turn off the TV while the screen is off, it comes on again the next time you turn on the TV.

# Featured Free (U.S. only)

*Only in connected mode in the United States*, use Featured Free to discover content that is free to watch.

As you browse through the programs, the featured channel's icon appears in the upper left corner of the screen. Use the purple directional pad to highlight a program, and then press **OK** to see more information about it.

Once you are viewing a program's details, press **OK** to start playing the program. If you've already added the channel, you'll be taken directly to the channel and the program will begin to play. If you have not added the channel, it will be added for you before playing the program.

If you don't want to see Featured Free on the Home screen menu, you can hide it.

To hide **Featured Free**:

1. From the Home screen menu, navigate to **Settings > Home screen**, and then press **RIGHT**.
2. Select **Featured Free**.
3. Highlight **Hide**, and then press **OK**.



# My Feed

*Only in connected mode*, use My Feed to find out when you can watch movies coming soon, and to get updates on movies, TV programs, and actors that you are following.

## Movies Coming Soon (U.S. only)

*Only in the United States*, My Feed gives you updates on your list of movies that are coming soon to theaters. With My Feed, you'll know when your favorite movie is ready to stream, the channels it is on, and how much it will cost.

Select the movies you want to follow by going to **My Feed > Movies Coming Soon**. You'll then see a list of newly released movies that are not yet available on Roku streaming devices. Select a movie, and then select **Follow this movie on Roku**. When you return to the main **My Feed** screen, you'll see banners for each of your newly-followed movies along with banners for movies and TV programs you're already following.

## Movies, TV programs, and people

In addition to following movies coming soon, you can follow any movie, TV program, or actor across top streaming channels. To follow a program, search to find the movie, TV program, or name that you want to follow, and then select **Follow this movie/TV show/person on Roku**. For more information, see [Searching for something to watch](#).

**Note:** *The TV takes a bit of time to update your newly-followed programs. Until it finds at least one channel offering the movie, the content banner in My Feed shows **Check back later for updates**.*

My Feed alerts you any time a movie or TV program you are following becomes available on another channel and whenever its price changes. A number in parentheses next to **My Feed** in the Home screen menu means that My Feed has updated information that you haven't viewed yet. For example, if three of your followed programs have updates, you'll see **My Feed (3)**.

**Note:** *When a movie or TV program you are following becomes available, the streaming channel offering the movie might require that you subscribe or pay a fee to view it.*

# Searching for something to watch

Searching for movies and programs across streaming channels and live TV is one of the unique features of your Roku TV. Within a single search operation, you can search by:

- Movie name
- TV program name
- Actor or director name
- Streaming channel name
- Interactive game name
- Music or podcast title or artist on Spotify
- Genre, including the special genres, “free” and “4K.”

**Note:** *Roku Search is only available if your TV is operating in connected mode and linked to a Roku account. Roku Search doesn't search across all streaming channels, but searches across lots of popular streaming channels. The actual channels it searches vary by locale.*

## How do I search?

You can search in several different ways:

- By using an on-screen keyboard that you navigate using the purple directional pad on your remote
- By typing on the Roku mobile app on your phone or tablet
- By speaking search phrases in English or Spanish using a Roku Voice remote, the Roku mobile app, Alexa, or Google Home Assistant. Participating channels show results without leaving the channel you are viewing. Results from the active channel appear in the first row, followed by results from other channels.

For more details about Voice Search, go to [go.roku.com/voicesearch](https://go.roku.com/voicesearch).

## Keyboard search using the remote

1. Select **Search** on the Home screen menu.
2. Use the purple directional pad to navigate the on-screen keyboard, entering a few characters of the search term.

Each additional character you enter narrows down the search, making the search results more relevant. You'll often see the results you are seeking after entering only a few letters.

3. When you see the program you are searching for, press **RIGHT** to highlight it. Continue pressing **RIGHT** to see more details about how to watch the program.

## Voice Search from a Roku Voice remote

*Only with models that have a Roku Voice remote:*

1. Press and hold either **VOICE**  or **SEARCH** , or say "Hey Roku," depending on your remote.

**Hint:** Tap the button to see on-screen tips about searching. Repeat to see a different set of tips.

2. While holding down the button, say the name of a movie, TV program, actor, director, or genre (including the special genres, "free" and "4K"). You also can search for news programs. Say things like, "Show the news," "Play news," or "Play news on newsy."

**Note:** You can use either English or Spanish for voice searches, according to the TV language you set in **Settings > System > Language**.

The TV lists the results of your search across many streaming channels and, *only in the United States*, live TV channels.

3. Press **RIGHT** to move the highlight into the list of search results.
4. Press **UP** or **DOWN** to scroll through the list of search results to highlight the item you want to view.

## Searching from the Roku mobile app

Use the free Roku mobile app on your compatible smartphone or tablet to make searching even faster. Use your mobile device's keypad to type more quickly and easily than with the on-screen keyboard on your TV. Or, search by touching the Voice Search icon and saying the name of the movie, TV program, actor, director, genre, streaming channel, or game.

When you use the Roku mobile app to search, search results are shown on your mobile device instead of on the TV screen. When you make a selection from the search results, the TV starts playing the selected program.

For more information, see [Roku mobile app](#).

## Searching with Google Assistant

Use your Google Home, Google Pixel phone, or the Google Home mobile app to search for programs:

1. Link your Roku account to your Google account using the Google Home mobile app on your iOS or Android device.
2. Start your command with *"Hey Google"* or *"OK Google,"* and follow the command with *"on Roku."* Some examples:
  - *"Hey Google, show me documentaries on Roku."*
  - *"OK Google, show me comedies on Roku."*

**Note:** *You also can issue commands to control your Roku TV. And, if you have enabled **Fast TV Start** on your TV, you can turn on your TV by saying, "OK Google, turn on Roku."*

For more information about setting up and using Google Assistant with your Roku TV, see <https://support.roku.com/article/360009649613-how-do-i-control-my-roku-streaming-device-with-the-google-assistant->.

## Searching with Amazon Alexa

Use your Amazon Echo Dot, Echo Plus, Echo Show, or the Amazon Alexa mobile app to search for programs:

1. Link your Roku account to your Amazon account using the Amazon Alexa app on your iOS or Android device.

2. Start your command with “*Alexa,*” and follow the command with “*on Roku.*”

Some examples:

- “*Alexa, turn up the volume on Roku.*”
- “*Alexa, show me documentaries on Roku.*”

**Note:** *You also can issue commands to control your Roku TV. And, if you have enabled **Fast TV Start** on your TV, you can turn on your TV by saying, “Alexa, turn on Roku.”*

For more information about setting up and using Amazon Alexa with your Roku TV, see <https://support.roku.com/article/360017961074-how-do-i-use-amazon-alexa-with-my-roku-streaming-device->.

## Direct-to-playback search results

With direct-to-playback, voice search results jump directly to and start playing the program whenever your search command can be uniquely identified and the requested content is available at no additional cost to you.<sup>1</sup>

---

<sup>1</sup> Direct-to-playback commands work with selected streaming channels. Direct playback occurs only when there is a high confidence of match, the content is free or you are already subscribed, and the channel is already added to your Home screen.

## Searching for free content

You'll discover an almost endless list of content through your Roku TV, and much of it is free. You can easily find free content by including the word "free" in your search.

For example:

- **Roku Voice remote or Roku mobile app**—Say, "Show me free comedies" or "Show me free romance," or simply, "Show me free shows."
- **Google Home, Google Pixel phone, or the Google Home mobile app**—Say "OK Google, show me free programs on Roku," or "Hey Google, show me free documentaries on Roku."
- **Amazon Alexa**—Say "Alexa, show me free miniseries on Roku" or "Alexa, show me free dramas on Roku."

## I found a program. Now what?

Now that you've highlighted the program, movie, actor, game, or streaming channel you were looking for, press **RIGHT**.

If your search result was an actor, director, or other item that does not represent a single item of content, you'll see another list to narrow down your search. If you do a Roku Voice search, the TV shows visual search results rather than a list of text results. In all cases, use the purple directional pad to find the program you want to watch.

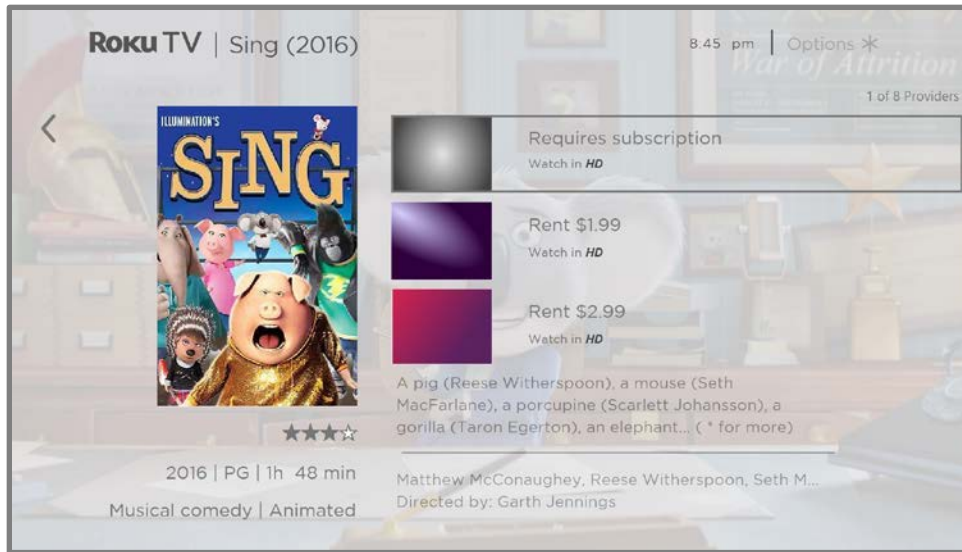

If your search result was a game or a streaming channel, you will see detailed information, images, and available actions, such as a list of results and the cost, if any, of using the item or channel.

**Note:** *Some channels may require a paid subscription.*

## Follow on Roku

Rather than watch the program you found in Search, you can add it to My Feed and wait until it's available on a particular streaming channel or available at a better price. From the search results screen, select **Follow on Roku**. Then go to **My Feed** periodically to check for updates to each of your followed movies, TV programs, or people. For more information, see [My Feed](#).

## Recent Searches

The next time you use **Search** from the Home screen menu, the **Search** screen displays a list of recent search selections in place of the search instructions.

Using the recent search selections list makes it easy to quickly get to a previously found item, for example, to find another movie with the same actor, or another TV program in the same series.



## Roku Zones (U.S. only)

*Only in the United States,* Roku Zones are search results grouped within popular genres, for example, “action,” “comedy,” and “horror.” To see Roku Zones in search results, search for a genre name and look for the word **Zone** added to the end of a search result. Or, to see all Roku Zones, search for “zone” and then scroll down in the results until you pass other programs beginning with “zone.”

When you open a Roku Zone, the results are organized into browsable rows such as “New Releases,” “Included With Subscription,” “Free,” “Rent / Buy,” “Rent for \$3 or less,” “Classic Movies & TV Shows,” and others. If you’re searching on a 4K Roku TV, results also include an “Available in 4K” row.

You can select a title to view channel availability and pricing information, and then select the channel to watch. To go back without making a selection, press **BACK** ←.

# Using the Roku Channel Store

*Only in connected mode*, either the **Channel Store** menu option or the **Add Channels** shortcut takes you to the Roku Channel Store, where you can add new subscription based and free streaming channels to your TV.

**Tip:** *Search for streaming channels by using the **Search** option, as explained in [Searching for something to watch](#). Use Roku Voice Search if you prefer. When you use Voice Search, if your TV recognizes a channel name, it launches the channel if you already have installed it. Otherwise, it offers to install it for you. At that point, you can choose to install or cancel.*

To make it easier to find what you want, the streaming channels in the Roku Channel Store are categorized by topic. Press **UP** or **DOWN** to highlight the category you want, and then press **RIGHT** to move the highlight into the grid of streaming channel tiles.

When you find a streaming channel you want to add or learn more about, highlight it and press **OK** to display more details.

- If the streaming channel you are adding is free, you can select **Go to channel** to start watching it immediately.
- If there is a one-time or recurring fee associated with using the streaming channel, you must agree to the terms and conditions, accept the fee, and—if you created one when you activated your Roku TV—enter your Roku PIN code to authorize the charges.
- If you already have a subscription to the channel—for example, you already subscribe to Netflix or you receive HBO through your cable TV provider—you must complete a different, simple authorization step to add the streaming channel.

You need only complete the authorization or activation step one time, when you initially add the streaming channel. After that, you just select the streaming channel tile from the Home screen to start watching. (Channel and content availability are subject to change. Charges may apply to your selection.)

**Tip:** *New streaming channels are added continuously to the Roku Channel Store, so be sure to check back frequently for new options.*

**Note:** *If you don't remember your PIN, or if you want to change whether you need to use a PIN to make purchases on your Roku account, see [Roku account PIN](#).*

## Automatic Account Link

Some subscription channels take advantage of Automatic Account Link. If you have multiple Roku devices, channels that support this feature require you to supply your user name and password on only one device. For a growing list of channels that support this feature in the United States, see:

<https://support.roku.com/article/360021586854-how-do-i-set-up-my-subscription-channels-on-a-second-roku-streaming-device->

# Customizing your TV

There are several things you can do to personalize your TV.

## Add TV inputs

As you use your TV, you might find that you need to add a TV input tile that you did not add during Guided Setup. To add a TV input:

1. From the Home screen menu, navigate to **Settings > TV inputs**. Notice that the list of inputs is divided into two sections: **Inputs being used** and **Inputs not used**.
2. Press **UP** or **DOWN** to highlight an input in the **Inputs not used** section of the list.
3. Press **RIGHT** to move the highlight to **Set up input**.
4. Press **OK** to add the input.
5. Press **HOME**  to return to the Home screen. Notice that the input has been added to the top of the Home screen. If you want to move the input tile to a different position in the grid, see [Rearrange tiles](#).

**Tip:** *If you purchase and connect a Roku premium audio product, such as a Roku Streambar™, your TV automatically controls all required sound settings, power, volume, and mute through your TV's remote control.*

## Add streaming channels

You can add streaming channels by searching in the Roku Channel Store from any of the following locations:

- **Channel Store** option
- **Search** (including Roku Voice Search)
- **Add Channels** shortcut

New streaming channels are added to the bottom of the Home screen. If you want to move the channel tile to a different position in the grid, see [Rearrange tiles](#).

**Hint:** *If you have multiple Roku devices, they all show the same set of streaming channels after their next daily update, unless the channel is not compatible with the device. So don't be surprised when you add a channel to your Roku TV and then see it the next day, for example, on your Roku Streaming Stick or Roku Streambar™.*

## Rename inputs

Rather than trying to remember that your Blu-ray™ player is connected to **HDMI 1** and your game console is connected to **HDMI 3**, you can rename the TV inputs to match the connected device.

**Note:** *Renaming an input also changes the icon associated with it.*

To rename an input, you can either:

- Highlight the input tile in the Home screen, and then press **STAR \*** to display a list of options. From the list of options, select **Rename input**. Then select a new name and icon.

or

- From the Home screen menu, navigate to **Settings > TV inputs**. On the **TV inputs** screen, select the input you want to rename, select **Rename**, and then select a new name and icon from the provided list.

Rather than using the predefined names and icons, you can set a custom name and icon. To do so, scroll up or down to highlight **Set custom name & icon**, and then press **OK**. Follow the instructions on the screen to enter a name and select an icon for the input.

Press **HOME**  to return to the Home screen. The new name and icon are now in effect.

## Remove unwanted tiles

It's easy to remove unused TV inputs and unwanted channel or app tiles. For example, if you never use the **HDMI 3** input, or if you don't like the weather app you added from the Roku Channel Store, you can remove them from your Home screen.

**Note:** *You also can remove the **Live TV** tile if you never use the TV tuner. But be aware that removing the **Live TV** tile also deletes the channel list. You'll have to set up the TV tuner again next time you want to view live TV. Instructions for setting up the TV tuner can be found in [Setting up live TV](#).*

- To remove any tile, highlight the tile in the Home screen, and then press **STAR \*** to display a list of options. From the list of options, select **Remove input**. In the screen that follows, confirm you want to remove the input.
- Alternatively, to remove a TV input tile, navigate to **Settings > TV inputs**. On the **TV inputs** screen, select the input you want to remove, and then select **Remove > Confirm**. Then press **HOME**  to return to the Home screen.

## Rearrange tiles

When you add a TV input tile, it's added at the top of your Home screen. When you add a new streaming channel, it's added at the bottom of your Home screen.

You can easily rearrange the order of the tiles on the Home screen to suit your viewing preferences. For example, you might want **Live TV** to be the first tile in your Home screen. But if you mostly watch one streaming channel, you might want its tile to be the first one on your Home screen.

1. On the Home screen, highlight one of the tiles you want to move.
2. Press **STAR \*** to display a list of options for the type of tile you selected.
3. Select **Move input** or **Move channel**. The list of options disappears and the highlighted tile shows arrows indicating how it can be moved.



**Note:** *A paid subscription or other payments may be required for some channels. Channel availability is subject to change and varies by country. Not all content is available in countries or regions where Roku® products are sold.*

4. Use the purple directional pad to move the highlighted tile to its new position. As you move the tile, it pushes other tiles out of its way.
5. Press **OK** to lock the tile into its new position.
6. Repeat these steps to move other tiles until you have arranged your Home screen to your liking.

## Change the look and feel with themes

*Only in connected mode*, another way to customize your TV is to change its theme. The theme establishes the look and feel of the TV through colors, designs, fonts, wallpaper (background), screensaver and, *only in the United States*, menu navigation sounds.

To change the theme, from the Home screen menu navigate to **Settings > Theme**. In the **Themes** screen, choose from the following options:

- **Theme packs** – *Only in the United States*, choose from a selection of packages that include coordinated wallpapers, screensavers, and sounds.
- **Wallpapers** – Select a wallpaper of your choice.
- **Screensavers** – Select a screensaver of your choice.
- **Sounds** – *Only in the United States*, select a sound set of your choice.
- **Wallpaper updates** – When this feature is on, Roku overrides your selected theme with a theme of their own choosing for various holidays and significant events. After the holiday or event passes, the TV reverts to your selected theme.
- **Screensaver wait time** – Select the idle time after which you want your selected screensaver to appear.
- **Restore default theme** – Every Roku TV has a theme based on the TV brand and model. Use this option to restore that default theme.

## Hide streaming TV channels (U.S. only)

*Only in the United States*, by default the Live TV Channel Guide shows both antenna channels and streaming channels in one list. If you prefer, you can hide streaming channels from the Live TV Channel Guide.

To hide streaming TV channels, from the Home screen menu, navigate to **Settings > TV inputs > Live TV > Hide streaming TV channels**, and then highlight **Hide all** and press **OK**.



## Change menu volume

Menu sounds are the noises the TV makes to let you know it received your command. You can change the volume of these menu sounds or turn them off.

To adjust the menu volume, from the Home screen menu, navigate to **Settings > Audio > Menu volume**. Navigate to the right and then change the setting to **High, Medium, Low, or Off**.

## Configure power settings

Power settings configure features related to how your TV's power settings work.

### Power on settings

Power on settings tell the TV what to do when you turn on the power. To configure the power on settings, from the Home screen, navigate to **Settings > System > Power > Power on**. Highlight the preferred power on location in the list, and then press **OK**.



## Auto power savings

To help you save energy, your TV can automatically turn itself off after a period of inactivity or a period during which no signal has been detected. It is factory-configured to do both of these things, but you can change these settings if needed.

To configure automatic power off, from the Home screen menu navigate to **Settings > System > Power > Auto power savings**. In the **Power settings** screen, highlight the following options and press **OK** to turn them on or off:

- **Reduce power after 15 minutes** – If no video or audio activity and no user interaction occur for 15 minutes, the TV automatically turns off the screen and sound.
- **Turn off after 4 hours** – If no video or audio activity and no user interaction occur for 4 hours, the TV goes into standby mode.

## Standby LED On/Off

Normally, the status indicator is lit whenever the TV is in standby mode. If you prefer the status indicator to not be lit in standby mode, you can turn it off. To do so, from the Home screen menu, navigate to **Settings > System > Power > Standby LED**, and then select **Off**.

After making this change, the status indicator still performs all other indication functions.

## Fast TV start

*Only in connected mode*, you can enable **Fast TV start**. As you might expect, **Fast TV start** lets you start watching your TV almost instantly after turning it on. But it also enables other convenient features, such as the ability to listen to certain music channels with the TV screen off and the convenience of being able to turn on and control your TV using voice commands.

Be aware that enabling **Fast TV start** makes your TV use somewhat more power when it is powered off to standby mode.

# Configure accessibility

Accessibility settings enable users with vision or hearing impairment to use the TV more effectively. Accessibility settings are located under **Settings > Accessibility**. (In Canada, captions settings are located under **Settings > Captions**.)

## Captions mode

The **Captions mode** settings specify when closed captions appear. Change caption settings from the Home screen menu by selecting **Settings > Accessibility > Captions mode**. At this point, you can choose among the following options:

- **Off** – No captions appear.
- **On always**– Captions appear whenever they are available from the program source.
- **On replay**– Captions appear only when you use the replay feature, and only when you are watching a streaming program that supports instant replay, watching a video through the Roku or USB media player, or watching a TV channel after enabling Live TV Pause.
- **On mute** – Captions appear only when the TV is muted.

**Tip:** *You can also change the captions mode while watching a program. Press **STAR \*** to display the **TV settings** menu, and then select **Closed captioning**. However, note that some streaming channels require you to enable captions through a setting within their channel even though you have turned on captions elsewhere.*

**Note:** *Once enabled, the captions mode applies to all inputs that support captions and remains enabled until you turn it off.*

## Captions preferred language

Use the **Captions preferred language** setting to select the language in which you want closed captioning to appear when that language is available. If your preferred language is not available, then captioning reverts to the default language for the program, which usually is English.

Highlight the language you prefer, and then press **OK** to select it.

## Captions style

Use these settings to control how closed captions look when displayed on your TV. At this point, you can choose among the following options:

- **Text style** – Choose from a list of fonts. As you move the highlight to each font, you can see a sample of the result in an adjacent panel.
- **Text edge effect** – Choose from a list of edge effect styles, such as raised, depressed, and various shadows. As you move the highlight to each effect, you can see a sample of the result in an adjacent panel.
- **Text size** – Choose from a list of sizes. As you move the highlight to each size, you can see a sample of the result in an adjacent panel.
- **Text color** - Choose from a list of colors for the text. As you move the highlight to each color, you can see a sample of the result in an adjacent panel.
- **Text opacity** - Choose from a list of opacity settings for the text. This setting determines how much the area behind the text shows through the text. A value of 100% blocks all of the content behind the text. As you move the highlight to each setting, you can see a sample of the result in an adjacent panel.
- **Background color** - Choose from a list of colors for the background area behind the text. As you move the highlight to each color, you can see a sample of the result in an adjacent panel. Note that you won't see any change unless you set the **Background opacity** to a value other than **Off**.
- **Background opacity** - Choose from a list of opacity settings for the background of the caption. This setting determines how much the area behind the caption background shows through the background. A value of 100% blocks all of the content behind the background. As you move the highlight to each setting, you can see a sample of the result in an adjacent panel.

- **Window color** - Choose from a list of colors for the window rectangle surrounding the entire caption. As you move the highlight to each color, you can see a sample of the result in an adjacent panel. Note that you won't see any change unless you set the **Window opacity** to a value other than **Default** or **Off**.
- **Window opacity** - Choose from a list of opacity settings for the window rectangle surrounding the entire caption. This setting determines how much the area behind the caption window shows through the window. A value of 100% blocks all of the content behind the window. As you move the highlight to each setting, you can see a sample of the result in an adjacent panel.

## Screen reader settings (U.S. only)

*Only in the United States with English language selected,* screen reader settings help users who are blind or visually impaired to configure the text-to-speech reader, enabling them to operate their TV more easily. The screen reader uses voice prompts that speak volume and channel changes, menu options, and setting changes. Access screen reader settings from the Home screen menu by navigating to **Settings > Accessibility**, and then select from the following options in the **Screen reader** section:

- **Screen reader** - Turn the screen reader on or off.
- **Speech rate** - Select one of four speeds at which to hear spoken guide information: **Slow**, **Normal**, **Fast**, or **Very Fast**.
- **Volume** - Select the volume at which to hear spoken guide information, relative to the main TV volume.
- **Shortcut** - Enable or disable the shortcut feature. When enabled (the default), pressing **STAR \*** four times in quick succession enables or disables the screen reader.

# Customize the Home screen

If you prefer to not see certain features on the Home screen, you can hide them. From the Home screen menu, navigate to **Settings > Home screen**, and then press **RIGHT**. Select either **Hide** or **Show** for each of the following Home screen items:

- **Featured Free** (U.S. connected mode only)
- **What to Watch** (U.S. connected mode only)
- **Discover Today** (U.S. connected mode only)
- **Live TV**
- **Movie Store and TV Store** (U.S. connected mode only)
- **Channel Store**
- **My Offers** (U.S. connected mode only)
- **Shortcuts**

# Parental controls

Parental controls enable you to control whether the members of your household can view certain kinds of broadcast TV programs. When a program or feature is blocked, you can unblock it by entering a parental control PIN that only you know.

**Note:** *Parental controls block content from the TV tuner and from streaming options, if any, on the Home screen menu. Parental controls do not block content on other TV inputs or content from streaming channels you add to your TV.*

## Creating a parental control PIN

The first time you access the **Parental controls** screen, you must create a new parental control PIN. Thereafter, whenever you want to change parental control settings, unblock programming that has been blocked, change the PIN, or disable parental controls, you must enter your parental control PIN.

**Tip:** *Your parental control PIN has no connection to your Roku account PIN. You can make them the same if you want—this is entirely your choice.*

To create a new parental control PIN, from the Home screen menu navigate to **Settings > Parental controls**. The screen displays a numeric keypad. Use the purple directional pad to enter a four-digit code, and then press **OK**. Then repeat the process to enter the same PIN again, just to make sure you correctly entered the PIN you want to use.

**Important:** *If you forget your parental control PIN, **the only way to recover is to perform a factory reset operation**, as explained in [Factory reset everything](#).*

# Blocking broadcast TV programs

For broadcast TV, parental controls use information embedded in the broadcast signal to determine whether to allow a program to be displayed. Parents can configure parental controls to block broadcast TV programs that meet or exceed a specific rating, so they cannot be viewed or heard unless the correct parental control PIN is entered.

**Note:** *Rating standards differ by country.*

## Enabling parental control of TV programs

The first step in blocking TV programs is to enable parental control of TV programs.

This setting is provided separately to make it easier for you to turn parental control of TV programs on and off without disturbing their settings. For example, your kids are going to summer camp for two weeks, and while they are gone, you don't want to have to deal with unblocking programs that you want to watch by entering your parental control PIN. All you need to do is clear **Enable parental controls**, and all TV programs are unblocked. When the kids return, select **Enable parental controls** again, and all of your parental control settings are restored in a single operation.

To enable parental control of TV programs:

1. In the Home screen menu, navigate to **Settings > Parental controls**, and then enter your parental control PIN.
2. In the **Parental controls** screen, navigate to **TV tuner > Parental control of TV shows**.
3. Make sure the check box next to **Enable parental controls** is checked. If not, highlight it and press **OK**.



## Blocking based on US TV ratings

Most broadcast US TV programs—other than movies—contain rating data that enables parental controls to block programs that parents don't want others to view. The ratings are divided into two groups that function independently:

- **Youth group** – TV-Y, TV-Y7
- **Main group** – TV-G, TV-PG, TV-14, TV-MA

Within each of these groups, the ratings interact such that if you block a particular level of content, the TV also blocks all content with a higher rating. Conversely, if you unblock a particular level of content, the TV also unblocks all content with a lower rating. For example, if you block TV-PG programs, the TV also blocks TV-14 and TV-MA programs. If you subsequently unblock TV-14 programs, TV-PG programs are also unblocked, but TV-MA programs remain blocked.

Similarly, within the main group, content types can be individually blocked. For example, you can block just coarse language in programs with a TV-PG rating. If you do, then the TV also blocks programs with coarse language in the higher ratings (TV-14 and TV-MA). Subsequently unblocking coarse language in TV-14 ratings does not unblock coarse language in TV-MA programs, but it does unblock coarse language in TV-PG programs.

To block TV programs based on US television ratings:

1. From the Home screen menu, navigate to **Settings > Parental controls**, and then enter your parental control PIN.
2. In the **Parental controls** screen, navigate to **TV tuner > TV ratings**. Choose among the following settings:
  - **Entire ratings** – Highlight the rating you want to block, and then navigate to the right and select the first option that blocks the entire rating level (and all higher rating levels).
  - **Individual content types** – Highlight the rating that contains the content type you want to block, and then select the content types you want to block from among those listed. Remember that blocking a content type in one rating blocks the equivalent content type in all higher rating levels.

## Blocking based on US movie ratings

Most movies in the US are rated by the Motion Picture Association of America, or MPAA, so the ratings are known as MPAA ratings. TV broadcast signals carry movie rating data that enables parental controls to block programs that parents don't want others to see. The ratings are:

- G – General audiences
- PG – Parental guidance suggested
- PG-13 – Parents strongly cautioned for children age 13 or younger
- R – Restricted
- NC-17 – Not for age 17 or younger

Unlike US TV ratings, there are no individual content types within the ratings. But like TV ratings, blocking movies with a particular rating also blocks movies with a higher rating, and unblocking movies with a particular rating also unblocks movies with a lower rating.

**Tip:** *Blocking movies with an NC-17 rating also blocks programs with the now-obsolete X rating, which can still occur in the program data of older movies.*

To block movies based on MPAA ratings:

1. From the Home screen menu, navigate to **Settings > Parental controls**, and then enter your parental control PIN.
2. In the **Parental controls** screen, navigate to **TV Tuner > Movie ratings**.
3. Select the rating level you want to block. You need only select one rating level, and all higher levels are automatically blocked.

## Blocking based on Other ratings

Your TV can block programs having ratings that had not been defined when the TV was manufactured. It does this by detecting a new Rating Region Table in a program and then downloading the new table and displaying its rating in the Parental controls.

When the TV downloads a new Rating Region Table, it adds a new option to the list of rating types: **Other ratings**. If you see this option in the **Parental controls** screen, you have tuned to a station that has implemented a new rating table. Once the new

rating table has been downloaded to the TV, it remains in the TV until it is factory reset, and you can configure blocking based on the new ratings.

New Region Rating Tables can have independent rating levels, or rating levels that interact in the same ways as the built-in US TV and MPAA Movie ratings.

**Tip:** *If your TV downloads a new Region Rating Table, you'll have to experiment with its settings to understand how to use it.*

## Blocking based on Canadian English ratings

Canadian-English language and third-language programs that are broadcast in Canada are rated by the Action Group on Violence on Television, or AGVOT. TV broadcast signals carry rating data that enables parental controls to block programs that parents don't want others to view based on content containing violence, language, sex, or nudity. The ratings are:

- C - Children under 8 years
- C8 - Children 8 years and older
- G - Generally suitable for all age groups
- PG - Parental guidance suggested for viewers under 14 years
- 14+ - Generally not suitable for viewers under 14 years
- 18+ - Generally not suitable for viewers under 18 years

Blocking content with a particular rating also blocks content with a higher rating, and unblocking content with a particular rating also unblocks movies with a lower rating.

To block programs based on AGVOT ratings:

1. From the Home screen menu, navigate to **Settings > Parental controls**, and then enter your parental control PIN.
2. In the **Parental controls** screen, navigate to **TV tuner > Canadian English ratings**.
3. Select the rating level you want to block. You need only select one rating level, and all higher levels are automatically blocked.

## Blocking based on Canadian French ratings

Canadian-French language programs that are broadcast in Canada are rated by Québec's Ministry of Culture and Communications. TV broadcast signals carry rating data that enables parental controls to block programs that parents don't want others to view based on content containing violence, language, sex, or nudity. The ratings are:

- G - Generally suitable for all age groups
- 8+ - Viewers 8 years and older
- 13+ - Viewers 13 years and older
- 16+ - Viewers 16 years and older
- 18+ - Adults only

Blocking content with a particular rating also blocks content with a higher rating, and unblocking content with a particular rating also unblocks movies with a lower rating.

To block programs based on Canadian-French ratings:

1. From the Home screen menu, navigate to **Settings > Parental controls**, and then enter your parental control PIN.
2. In the **Parental controls** screen, navigate to **TV tuner > Canadian French ratings**.
3. Select the rating level you want to block. You need only select one rating level, and all higher levels are automatically blocked.

## Blocking unrated programs

Some broadcast TV programs and movies do not have an assigned rating, and are considered to be “Unrated”. Whether or not such programs contain content that is objectionable to you cannot be determined. However, you can choose to block such programs.

To block all unrated broadcasts:

1. From the Home screen menu, navigate to **Settings > Parental controls**, and then enter your parental control PIN.
2. In the **Parental controls** screen, navigate to **TV tuner > Block all unrated programs**.
3. Highlight **Unrated programs** and press **OK**. When blocking is enabled, the adjacent padlock icon changes from unlocked to locked.

**Tip:** *Blocking programs that have not been assigned a rating does not block programs that specifically have been assigned a US TV rating of “None” (for example a broadcast of a local town council meeting). Programs that do not have an assigned rating display **Rating NA** (for “not applicable,” meaning a rating is not needed).*

*In the absence of other ratings for a program, the parental controls do not consider the MPAA US movie rating **N/A** (MPAA rating not applicable to this content) and **NR** (applicable content not rated by the MPAA) to be ratings. In these cases, the TV handles the program as though it is unrated, blocking the program if **Unrated programs** blocking is enabled.*

# What happens when a TV program is blocked?

After you've set up parental controls, TV programs and movies are blocked:

- When you change channels and the new channel is playing a program whose rating exceeds your settings.
- When a new program comes on the channel you are watching and its rating exceeds your settings.

When a program is blocked by parental control settings, the TV displays a blocked message:



Whenever this blocked message appears, both the video and audio of the program are blocked, as well as program data that would normally appear in the area at the bottom of the screen. *Only in connected mode:* program title and information show as "Blocked" as well.

To watch the blocked program, you need to know the PIN code defined when you enabled parental controls, as explained in [Creating a parental control PIN](#).

1. Press **OK** to select **Unblock**. The Parental Control PIN pad appears.

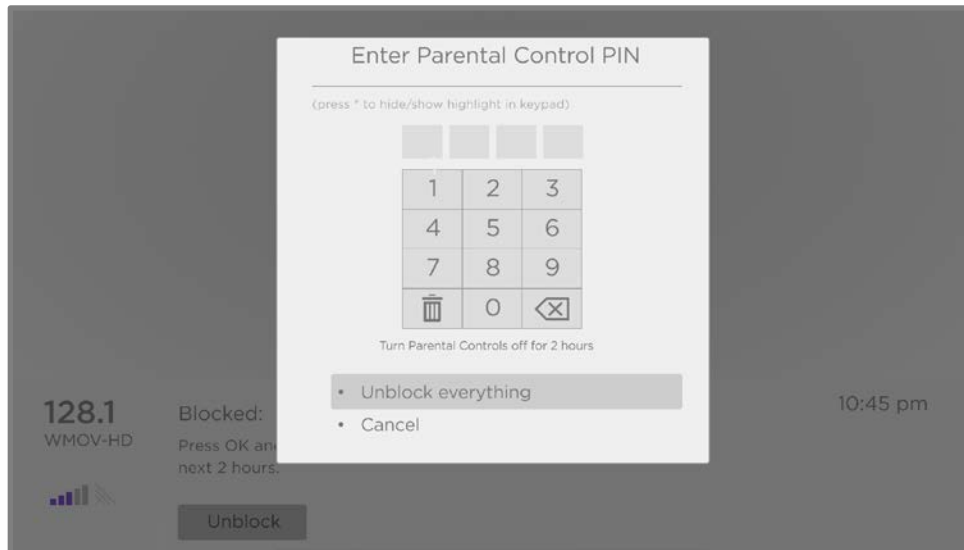

2. Use the purple directional pad to enter your parental control PIN code, and then press **OK** to select **Unblock everything**.

**Tip:** To shield your parental control PIN from others in the room, press **STAR \*** to hide the highlighted number. When you hide the highlight, you will have to count key presses to keep track of which number is selected.

After unblocking programs that have been blocked, all blocking is disabled for two hours or until you turn off the TV.

## Changing the parental control PIN

To change your parental control PIN:

1. From the Home screen menu, navigate to **Settings > Parental controls**, and then enter your parental control PIN.
2. In the **Parental controls** screen, highlight **Change PIN**.
3. Move the highlight into the adjacent keypad, and then use the purple directional pad to enter a four-digit code, and then press **OK**. Then repeat the process to enter the same PIN again, just to make sure you correctly entered the PIN you want to use.

## Resetting parental controls

So now your kids have grown up and gone away to college, and you no longer want to deal with blocked programs.

To erase all parental control settings:

1. From the Home screen menu, navigate to **Settings > Parental controls**, and then enter your parental control PIN.
2. In the **Parental controls** screen, highlight **Reset parental controls**.
3. Follow the instructions on the screen to confirm that you want to erase all parental control settings.

**Tip:** *Resetting parental controls also erases your parental control PIN.*



# More settings

This section describes the features and settings of the TV that were not covered in the other parts of this guide.

## Guest Mode

*Only in connected mode*, when you enable Guest Mode, your guests can sign in to subscription channels using their own account credentials instead of using yours. Your guests' credentials are then automatically removed on the date they specify.

By enabling Guest Mode, your guests won't have access to your personal streaming channel accounts and won't be able use your Roku account to make purchases. Instead, your guests can safely access their own subscription channels. And they won't have to remember to sign out before they leave.

To enable Guest Mode:

1. From the Home screen menu, navigate to **Settings > System > Guest Mode**.
2. Select **Enter Guest Mode**.
3. Use the purple directional pad to enter your Roku account PIN in the on-screen keypad.
4. Select **OK** to confirm and put the TV into Guest Mode.

**Note:** *You also can enable and disable Guest Mode remotely logging in to [my.roku.com](https://my.roku.com) on your computer or smart phone, logging in to your account, scrolling down to **My linked devices**, and then selecting **Enable Guest Mode** or **Disable Guest Mode**, respectively.*

After you put your TV into Guest Mode, it is ready to welcome your guests, allowing them to select a sign-out date. On the Home screen, they will find an assortment of default subscription channels They can enjoy free content from The Roku Channel and many others, or sign-in and watch movies and TV programs from their own

subscriptions and saved content libraries. Your guests can use the Roku Channel Store to find and add channels they watch at home with confidence that they automatically will be removed on their sign-out date.

For more information about the experience your guests will have when Guest Mode is enabled in the United States, see:

<https://support.roku.com/article/360015612834--how-do-i-set-up-auto-sign-out-mode-for-my-guests->

To disable Guest Mode:

1. Press **HOME**  to return to the Home screen menu.
2. Navigate to **Settings > System > Guest Mode**.
3. Select **Exit Guest Mode**.
4. Use the purple directional pad to enter your Roku account PIN in the on-screen keypad.
5. Select **OK** and confirm that you want to disable Guest Mode.

After you disable Guest Mode, all of your original settings are restored and your channels are reinstalled. You might need to sign in to your subscription channels again to access your content.

**Note:** *Any game data that was stored on your Roku device is not restored.*

# Network settings

If needed, you can change your network settings at any time. For example, if you change the name of your wireless network (its SSID) or its password, you will need to change your TV's settings so that it can continue to connect. Also, if you decided not to connect to the Internet in [Guided Setup](#), you can use network settings to connect at a later time.

To change network settings, from the Home screen menu, navigate to **Settings > Network**, and then press **RIGHT**. At this point, you can choose from among the following options:

- **About** - Lists important information about your current network connection, such as status, connection type, IP addresses, and MAC address. This information is often useful when contacting customer support with connection issues.
- **Check connection** - Select your existing network connection type, and then press **OK** to start checking the network connection. The TV uses your current network information to reconfirm the wireless or wired network connection to the local network and the Internet connection.
- **Set up connection** - Select a network connection type, and then select the option to set up a new connection. Follow the on-screen instructions to complete the network connection. For help with each of the steps, see [Network connection](#).
- **Bandwidth saver** - Enable or disable this feature as appropriate. If **On**, your TV prompts you to stop streaming if you haven't used the remote control within the past four hours. If you do not respond, streaming stops to save your data allocation and increase the network bandwidth available to other devices in your home. Change to **Off** to disable the automatic bandwidth saving feature.

**Note:** *Some networks, such as those found in dorm rooms, hotels, and other public places, may require you to read and agree to terms, enter a code, or provide identifying information before letting you connect to the Internet. For more information, see [Using your TV in a hotel or dorm room](#).*

## ZIP Code or postal code

Your TV needs to know your ZIP Code (*United States*) or postal code (*Canada*) so that it can display the correct channels and program guide information. It attempts to determine your location by using information from your Internet connection; however, the information available from this source is not always accurate. To ensure you have the most accurate program guide information, use the **ZIP Code** or **Postal code** option to enter your correct code.

To set your correct location, from the Home screen menu, navigate to **Settings > System > ZIP Code** (or **Postal code**), and then press **RIGHT**. Use the purple directional pad to enter your code in the on-screen keypad, and then select **OK**.

## Time settings

You can change time settings to suit your preferences. You can find the following settings by navigating from the Home screen menu to **Settings > System > Time**:

- **Sleep timer** – Set a time delay after which the TV will automatically shut off. This setting reflects the setting you can make in the **TV settings** menu from any TV input, as explained in [TV settings menu](#).

**Note:** *The sleep timer setting is not input specific, and also can be set by using the **Sleep timer** shortcut in the Home screen grid.*

- **Time zone** – Correct time zone information is needed to correctly display program data. Choose whether to set the time zone automatically or manually, and if set manually, select your current time zone. Usually, a TV connected to the Internet can discover its own time zone automatically, but sometimes a TV that is not connected to the Internet cannot and so must be set manually. Initially, this setting is made when you set up the TV tuner, as explained in [Setting up live TV](#).
- **Clock format** – Choose whether to display time in a 12-hour or 24-hour format, or to turn off time display. *This setting is available only on TVs that are connected to the Internet. Non-connected TVs do not display the time.*

## Scan again for live TV channels

There will be times when you need to create a new channel list. For example, you:

- Change cable providers
- Reorient your TV antenna
- Move to a different city with different channels

Whenever you need to update your TV channel list, you can repeat the channel scan.

**Tip:** *Even if you don't change anything related to your TV channel reception, you should repeat the channel scan from time to time to make sure you are receiving all of the latest channels. Broadcasters add and remove channels, move channels to different parts of the spectrum, and change the power levels of their channels periodically.*

**Note:** *Repeating the tuner channel scan unhides all hidden channels.*

To repeat the channel scan, highlight the **Live TV** tile on the Home screen, and then press **STAR \***. Next, select **Scan for channels** and press **OK**. After that, the screens and options that appear during this process are identical to those described in [How do I set up the TV tuner?](#)

## HDMI® mode (4K models only)

On 4K (UHD) TVs, you can independently configure each **HDMI** input to match the capabilities of the connected device. From the Home screen menu, navigate to **Settings > TV inputs**, and then select an enabled **HDMI** input. Next, select **HDMI mode** and then select one of the following settings:

- **Auto (recommended)** – Let the TV determine the best setting. Use this option unless your HDMI® device does not correctly communicate its HDMI® version information.
- **Standard** – Configure the input for compatibility with HDMI® version 2.0, which supports a maximum refresh rate of 60 Hz at full UHD resolution. You must use this mode to view HDR content from the device connected to this **HDMI** input. However, note that many older HDMI® devices do not work correctly when the TV's HDMI input is set to this mode. After enabling this setting, you can optionally turn **Auto low latency mode** (ALLM) off or on.
- **Compatibility** – Configure the input for compatibility with HDMI® version 1.4, which supports a maximum refresh rate of 30 Hz at full UHD resolution. Most HDMI® devices will work correctly with the TV in this mode.

## Control by mobile apps

You can choose the level of control you want to allow your TV to accept from external devices, such as smart phones, tablets, and virtual assistants. Device connect settings enable other devices, including the Roku mobile app, to control your TV over the local area network in your home.

To adjust the level of external control access:

1. From the Home screen menu, navigate to **Settings > System > Advanced system settings > Control by mobile apps**.
2. Select **Network access**.

3. Select one of the following settings:
  - **Default** – Devices can connect only through a private network address, and accept commands only from other private network addresses on your home network. This setting is suitable for most cases, including use of the Roku mobile app on your smartphone.
  - **Permissive** – Devices can connect under all conditions, but accept commands only from private network addresses or the same subnetwork within your home network. This setting might be required when attempting to operate the TV from a third-party application, for example, one of the Internet of Things (IoT) applications such as ifttt.com.
  - **Disabled** – Device connection is completely disabled. The TV does not accept external commands from any source, including the Roku mobile app.

## Changing privacy settings

**Note:** *Privacy settings are present only on TVs operating in connected mode.*

### Advertising

In connected mode, your TV by default uses an advertising identifier to track your TV usage. You can change the privacy settings on your TV in two ways: resetting the advertising identifier and limiting ad tracking.

*To learn more about these options, please see Roku's Privacy Policy at [go.roku.com/PrivacyPolicy](https://go.roku.com/PrivacyPolicy).*

#### Reset the advertising identifier

Resetting the advertising identifier clears the prior usage history that your TV stores, and then begins tracking again. From that point forward, your new usage patterns affect the advertisements you see on your TV.

1. From the Home screen menu, navigate to **Settings > Privacy > Advertising**.
2. Highlight **Reset advertising identifier**. Press **STAR \*** to view more information about this option. When you finish reading the information, press **OK** to close the More Information window.

3. Press **OK** to reset the advertising identifier, and then press **OK** again to dismiss the verification message.

## Limit ad tracking

You can limit Roku's tracking of your usage behavior by limiting ad tracking. When you do, your TV will display ads that are not personalized based on your TV's advertising identifier.

1. From the Home screen menu, navigate to **Settings > Privacy > Advertising**.
2. Highlight **Limit ad tracking**. Press **STAR \*** to view more information about this option. When you finish reading the information, press **OK** to close the More Information window.
3. Press **OK** to select the **Limit ad tracking** check box.

**Note:** *If you perform a factory reset and then reconnect your TV, ad tracking is restored until you repeat these steps.*

## Microphone

Your Roku TV does not have a built-in microphone. However streaming channel providers can use the microphone on Roku Voice remotes (only on select models) or on your mobile device when the Roku mobile app is running. You can control whether streaming channels have permission to use the microphone.

**Note:** *These settings affect only streaming channel access to the microphone. They do not affect your Roku TV's Voice Search feature.*

## Channel microphone access

You can control which streaming channels have permission to use the microphone, giving you control over how the microphone is used by each streaming channel. The default setting is **Prompt**, so channels will not be able to turn on the microphone without your permission.



To change microphone access settings:

1. From the Home screen menu, navigate to **Settings > Privacy > Microphone**.
2. Select **Channel microphone access**.
3. Select one of the following settings:
  - **Prompt** – Display a notification the first time a streaming channel requests the use of the microphone. When such a notification appears, you can select either **Allow microphone access** or **Deny microphone access** on a per-channel basis. If you choose to allow microphone access, you'll be prompted to confirm your choice by entering a numeric code that appears on the screen.
  - **Always allow** – Do not prompt, but always allow any streaming channel to use the microphone.
  - **Never allow** – Do not prompt, but never allow any streaming channel to use the microphone.

## Channel permissions

After granting or denying microphone access on a per-channel basis, you can reset channel permissions to enable them to follow the system-wide setting you specify under [Channel microphone access](#).

To reset channel permissions:

1. From the Home screen menu, navigate to **Settings > Privacy > Microphone**.
2. Select **Channel permissions**.
3. Highlight **Reset channel permissions**, or highlight a specific listed channel, and then press **OK** to deny microphone access to all or to a specific channel.

## Smart TV experience

Only in the United States, if you have connected your TV to the Internet, your TV prompts you to [opt in to the Smart TV experience](#) when you first start watching TV programs. Regardless of your decision at that time, you can change your decision later.

To change your Smart TV experience choices:

1. From the Home screen menu, navigate to **Settings > Privacy > Smart TV experience**.
2. Highlight the setting you want to change, and then press **OK** to enable or disable it.
  - **Use info from TV inputs** - Authorizes Roku to collect and share information about what, when, and how you are watching and use this to make recommendations.
  - **Enable auto notifications** - Displays brief notifications from the Smart TV experience across the bottom of the screen when recommendations are available.

**Note:** *These settings do not affect recommendations for More Ways to Watch that you see in the Live TV Channel Guide when watching live TV channels.*

## Roku TV premium audio

Your Roku TV works with several Roku premium audio products, including the Roku Streambar™. Hold down **HOME**  for a few seconds to start the pairing process, and then follow the instructions on your TV screen to complete pairing.

With Roku TV premium audio devices, you can listen to all of your TV programs as well as the sound from any streaming channel. Select audio-only channels even let you listen to music with the TV screen turned off. After you have paired your speakers with your Roku TV, all sound normally comes from the paired speakers instead of the internal TV speakers.

If you have connected a Roku Streambar™ to your Roku TV, you can use the TV's **Sound settings** menu to control sound options, including sound mode, volume mode, speech clarity and virtual surround sound. See [Roku Premium Audio](#) for details.

## Home theater configuration

Your TV has several features that make it an ideal TV for a home theater. But you might not notice them because they remain in the background until you decide to use them.

### Controlling audio output

You can control how your TV outputs sound by navigating to **Settings > Audio > Audio output**. Choose from the following options:

- **Auto** – Let the TV decide the best way to output audio. It enables the S/PDIF optical port as well as either HDMI® ARC/eARC or the built-in TV speakers.
- **ARC (HDMI *n*)** – Always output audio to the indicated HDMI® ARC or eARC port (depending on model). Turn off the built-in TV speakers. The audio return channel (ARC) enables the TV to send Dolby Audio™ or DTS audio content back to a home theater receiver or Roku Streambar™ that is also sending an audio and video signal into the TV. Using HDMI® ARC or eARC reduces the number of cables needed and controls the volume and mute state of the receiver while watching TV.
- **TV speakers** – Always output audio to the built-in TV speakers.
- **Optical** – Always output audio to the S/PDIF optical port. Turn off the built-in TV speakers.

Regardless of which setting you choose, your TV automatically mutes the active audio output when you do any of the following:

- Plug headphones into the headphone jack on the TV.
- Plug headphones a Roku remote that supports wireless private listening.
- Turn on wireless private listening in the Roku mobile app.

## Setting up a digital audio connection

To take advantage of your TV's advanced audio capabilities, connect it to an external amplifier, receiver, or soundbar by using either of these two digital audio connections:

- **HDMI ARC or HDMI eARC** – The HDMI® Audio Return Channel (ARC) or *on select TVs only*, the HDMI® Enhanced ARC (eARC) connector enables the TV to output digital audio on one of its HDMI® connectors. The connected amplifier then can function simultaneously as an input source to the TV, if needed, without the need to use additional cables.

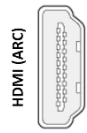

To use the ARC or eARC capability, you must connect an HDMI® cable from your amplifier's HDMI® ARC or eARC connector to the **HDMI ARC** or **HDMI eARC** connector on the TV. You also must do the following:

- Be sure your HDMI® cable is HDMI® certified.
- Select **Auto** or **ARC** under **Settings > Audio > Audio output**.
- **S/PDIF optical** – The S/PDIF optical connector outputs a digital audio signal. To use the optical output, connect a TOSLINK optical cable from the amplifier to the Optical or S/PDIF connector on the TV.



**Important:** *To make sure the S/PDIF outputs audio reliably, you must turn off the TV's speakers. To do so, from the Home screen menu, navigate to **Settings > Audio > Audio output** and change the setting to **Optical**.*

**Note:** *Dolby Audio™ support for Dolby Digital Plus™ format is not available through the S/ PDIF optical output. This format is only available through the **HDMI ARC** connection.*

**Tip:** *Even when you use S/PDIF for audio, the TV can correctly detect more audio formats if you connect an HDMI® cable between the TV's **HDMI ARC** or **HDMI eARC** port and the receiver's ARC or eARC port.*

## Choosing an audio format

After making the required HDMI® ARC, eARC, or S/PDIF optical connection, go to **Settings > Audio > Digital output format** and select the audio format to use.

Choosing **Auto** is the easy solution, and generally provides good results. However, if you have a high-end sound system and want to make sure you are getting the best sound quality available in the programs you are watching, you can choose another setting.

- **Auto** – Automatically detects the incoming audio format and transcodes it to a compatible available format for the audio output (ARC, eARC, or S/PDIF).
- **Passthrough** – Passes through the input audio to the connected receiver without transcoding, sometimes resulting in better audio quality especially for high-end audio formats such as those that take advantage of the higher bandwidth of eARC, including Dolby MAT and Dolby Digital Plus 7.1, among others.
- **Stereo** – Always outputs stereo, regardless of input audio format.
- **Custom** – When selected, reveals the following additional options for Dolby and DTS audio:
  - **Dolby** – Converts all input formats to either Dolby Digital or Dolby Digital Plus, according to the option you choose:
    - **Dolby Digital** – Converts all input formats to Dolby Digital.
    - **Dolby Digital Plus** – Converts all input formats to Dolby Digital Plus.
  - **DTS** – If you select **On**, converts all audio sources *except DTS* to Dolby Digital or Dolby Digital Plus according to the Dolby option you selected. If DTS is detected and the receiver supports DTS, this option passes through the DTS audio without modification. If you select **Off**, the TV does not detect or pass through DTS audio.

**Note:** *DTS audio formats are meant to be used with ARC, eARC, or S/PDIF connections to a DTS-capable home theater receiver. If you enable DTS when using the TV speakers, you might not hear any audio.*

## Turning off the TV screen while listening to music

Certain music channels enable you to turn off the TV screen while streaming music.

To turn off the TV screen on supported channels:

1. Press **STAR \*** to display the **TV settings** menu.
2. Press **DOWN** to highlight **Turn off display**.
3. Press **OK**.

**Tip:** *If you are using a Roku Voice Remote or the Roku mobile app, press **VOICE**  and say, “Turn off the display.”*

**Note:** *This feature is available only on select streaming audio channels, and only when the TV is operating in connected mode with **Fast TV Start** enabled. To enable **Fast TV Start**, from the Home screen menu, navigate to **Settings > System > Power**.*

## Controlling other devices through CEC

Consumer Electronics Control (CEC) enables your TV and other CEC-compatible home entertainment devices to control one another in various ways. First, the CEC-compatible devices must “discover” one another and report their capabilities. After this, one device can control another according to the features you enable. For example, playing a disc on a Blu-ray™ player could switch the TV to the Blu-ray™ player’s input. Or, powering off the TV could also power off the Blu-ray™ player and the home theater receiver.

### Discover connected CEC devices

To discover CEC devices:

1. Make sure that your CEC-compatible devices are connected to the TV with a suitable certified HDMI® Cable that supports HDMI® ARC and CEC control.
2. Turn on each device and make sure all devices are CEC enabled.

**Tip:** *Some manufacturers have their own branded names for CEC functionality, so you might need to read the product documentation to correctly identify the CEC features of the device.*

3. On the TV's Home screen menu, navigate to **Settings > System > Control other devices (CEC)** and then select **Search for CEC devices**. Press **OK** to repeat the discovery process, if necessary.

When finished, the TV displays a list of CEC devices that are connected to each **HDMI** input, as well as any devices that had previously been connected. The TV remembers the names of multiple CEC devices even when they are no longer connected. If the list is longer than the allowed space, press **STAR \*** to see a complete list in a scrollable window.

### Enable 1-touch play

1-touch play enables a device to control which TV input is active. For example, pressing **Play** on your Blu-ray™ player switches the TV to the Blu-ray™ input.

1-touch play is disabled by default. To enable 1-touch play, from the Home screen menu, navigate to **Settings > System > Control other devices (CEC)** and highlight **1-touch play**. Press **OK** to enable or disable the feature.

### Enable system standby

The system standby feature causes other devices to power off when you power off your TV. Depending on the CEC System Standby implementation, it also might enable connected devices to power off your TV when you power off the device.

System standby is disabled by default. To enable system standby, in the Home screen menu, navigate to **Settings > System > Control other devices (CEC)** and highlight **System standby**. Press **OK** to enable or disable the feature.

## Restart the TV

You can restart the TV when necessary. Restarting has the same effect as unplugging the TV power and then plugging it in again.

To restart the TV, navigate to **Settings > System > Power**, and then select **System restart**. Highlight **Restart**, and then press **OK** to confirm restart.

While the TV restarts, the screen goes dark for a few seconds, and then displays the startup screen for a few more seconds. When the restart operation completes, the TV displays the activity you selected in [Power on settings](#).

# Reset the TV

You can choose to reset only the TV picture and audio settings to their original values, or perform a full factory reset to return the TV to the state it was in when you first unpacked and turned it on.

## Reset audio/picture settings

To reset only the TV picture and audio settings to their original values, navigate to **Settings > System > Advanced system settings > Factory reset**, and then highlight **Reset TV audio/picture settings**. Read the information on the screen to make sure you understand what the reset operation does.

To proceed with the reset operation, press **PLAY/PAUSE**  three times in a row.

## Factory reset everything

A full factory reset returns the TV's settings to their original state and removes all personally identifiable information from the TV. When finished, you must repeat Guided Setup, reconnecting to the Internet, re-linking your Roku account, and reloading any streaming channels. You also must repeat live TV setup and input configuration.

Factory reset is the recommended choice if you want to transfer the TV to another owner, and it is the only choice if you want to switch from Store mode to Home mode (if you inadvertently selected Store mode during Guided Setup).

To perform a factory reset, navigate to **Settings > System > Advanced system settings > Factory reset**, and then highlight **Factory reset everything**. Read the information on the screen to make sure you understand what this reset operation does.

To proceed with the full factory reset, use the on-screen number pad to enter the code displayed on the screen, and then select **OK** to proceed.

When the factory reset operation completes, the TV restarts and displays the first Guided Setup screen.



## What if I can't access the Factory Reset option?

It is possible for your TV to get into a state where you cannot access the various menus, including the menu option that lets you perform a factory reset operation. If that happens, you can force the TV to reset by following these steps.

### Models with a RESET button

1. Using a straightened paper clip or ball-point pen, press and hold the recessed RESET button on the TV connector panel.
2. Continue to hold the RESET button for approximately 12 seconds.  
When the reset cycle completes, the status indicator comes on dim.
3. Release the RESET button. The TV is now powered off.
4. Turn on the TV and proceed through Guided Setup. See [Guided Setup](#).

### Models without a RESET button

1. On the TV panel (not the remote) press and hold down the MUTE and POWER buttons.
2. Unplug the TV power, and then plug it in while continuing to hold down the MUTE and POWER buttons.
3. When you see the startup screen appear on the TV, release the buttons.
4. Turn on the TV and proceed through Guided Setup. See [Guided Setup](#).

## Network connection reset

If you want to remove your network connection information without disturbing other settings, navigate from the Home screen menu to **Settings > System > Advanced systems settings > Network connection reset**, and then select **Reset connection**.

When you select this option, the TV removes your wireless network information, including the name of the connection (its SSID) and your wireless password, if any, and then it restarts. After restarting, your TV retains all of its other settings including its association with your Roku account.

After resetting your network connection, navigate from the Home screen menu to **Settings > Network > Set up connection** to set up your network connection and enjoy all of the benefits of your connected TV.

# Roku account PIN

When you created your Roku account, you were given the opportunity to create a PIN code and to specify when it must be used. Roku lets you optionally require that users enter your PIN as an additional verification method when making purchases through the TV or adding items from the Roku Channel Store. In addition, you must have a Roku account PIN before you can enable or disable Guest Mode.

If you created a Roku account PIN and want to change it, or you don't remember your PIN, or if you didn't create a Roku account PIN and want to add one, you can easily make these changes.

1. On a computer, tablet, or smartphone, use your web browser to go to <https://my.roku.com> and sign in.

After signing in, the **My account** page appears.

2. Under **PIN preference**, click **Update** to open the **Choose your PIN preferences** page.
3. Skip this step if you just want to change your PIN. Otherwise, choose the option you prefer from among those listed:
  - Require a PIN to make purchases or to add any item from the Channel Store.
  - Require a PIN to make purchases.
  - Do not require a PIN to make purchases.
4. If you choose either of the first two options, enter your PIN twice in the appropriate boxes.
5. Click **Save Changes** to save your changes and return to the **My Account** page. Note that your current setting is described under **PIN preference**.

# Update the TV

If your TV is operating in connected mode, it will automatically get updates from time to time. You don't need to do anything. But if you are aware that an update is available and you don't want to wait until the TV updates itself, you can manually check for updates.

If your TV is operating in non-connected mode, you can still get updates by using a USB flash drive.

You can download an updated User Guide that matches your Roku TV software version from the Roku web site at:

[www.roku.com/support](http://www.roku.com/support)

To determine your current Roku TV software version, go to **Settings > System > About**, and then press **OK** or navigate to the right.

## Checking for updates on a connected TV

If you're one of those people who has to have the latest, most up-to-date features the moment they are available, you can check for updates as often as you want.

To check for updates, navigate to **Settings > System > System update**, and then select **Check now**. The TV responds either with a message saying that your TV is up to date, or with a message saying that an update is available.

Follow the instructions on the screen to install the system update.

**Note:** *Sometimes system updates install new system software, and other times they install new features for streaming channels. Therefore, you won't always see a change in the behavior of your TV after a system update.*

## Getting updates on a non-connected TV

If your TV is not connected to the Internet, you can still get system updates by using a USB flash drive and a computer with an Internet connection.

To get a system update, navigate to **Settings > System > System update**:

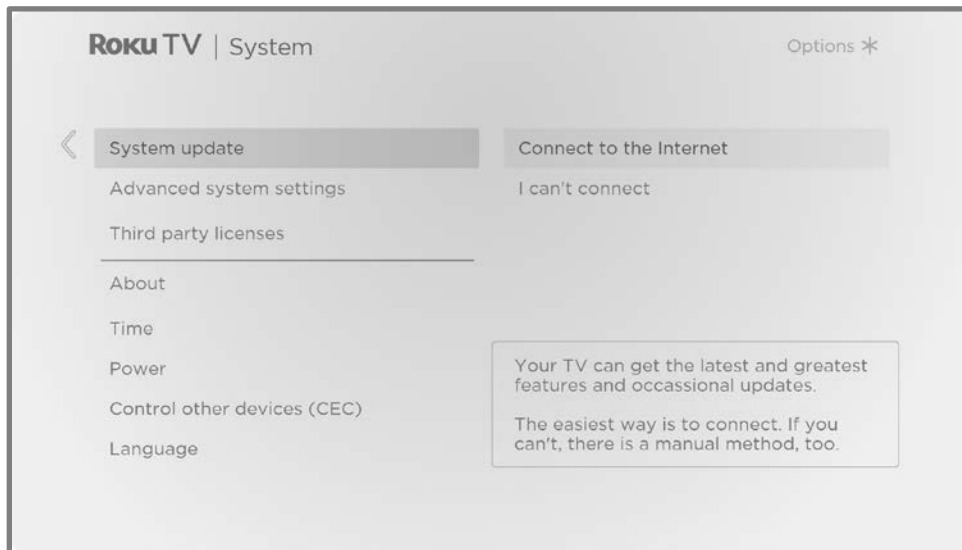

The **System update** screen on a non-connected TV gives you the opportunity to connect your TV to the Internet to automatically receive updates. We recommend this option if it is possible in your situation. To proceed, select **Connect to the Internet** and follow the instructions in [What if I didn't connect my TV?](#)

Otherwise, if you can't connect to the Internet, select **I can't connect**, and then follow the instructions on the screen. Here's a summary:

1. On an Internet-connected computer, go to the web site displayed on the **System update** screen.
2. On the **USB Update** web page, select the correct brand and model, and then click **Next**.
3. Click **Download Software**, and then save the file to the root folder of a standard USB flash drive.

---

## USB flash drive

Any normal USB flash drive will work, provided it has a FAT-16 or FAT-32 file system format. (This is the default for most flash drives.)

The size of the download is small—usually less than 100 MB—and so will fit on most any size flash drive you might have.

---

4. When the download finishes, take the USB flash drive to the TV and plug it into the USB port. When you do, the TV validates the files on the flash drive and displays a 12-digit code.
5. Write down the code and the web address, and take this information back to your Internet-connected computer.
6. On the **12-digit code** page, enter the code your TV displayed, and then click **Next**.
7. On the **6-digit code** page, write down the 6-digit code that appears, and then take it back to your TV.

---

## 12- and 6-digit codes

The USB update process uses a pair of codes to validate that you are authorized to install an update, and to ensure you are not attempting to install an old, unsupported version of the system software.

---

8. Using the TV remote, select **Next** to move to the next screen, and then use the on-screen keyboard to enter the 6-digit code. When finished, select **OK**. The system update begins. Do not remove the USB flash drive until the TV restarts.

When the update finishes, the TV restarts. You can check the new version number by navigating to **Settings > System > About**.

# Other devices

## Mirror your phone or tablet

*Only in connected mode*, your TV has a feature called screen mirroring that lets you mirror your compatible smartphone or tablet on your TV. Share videos, photos, web pages, and more from compatible devices.

By default, your TV's screen mirroring mode is set to **Prompt**. In this mode, when your TV receives a screen mirroring request, it prompts you with the following options, unless you have previously selected **Always allow** or **Never allow** for the device:

- **Always allow** – Always accept mirrored content from the mobile device without additional prompting in the future for this device.
- **Allow** – Accept mirrored content from the mobile device this time only. Prompt again next time this device attempts to mirror content.
- **Block** – Do not accept mirrored content from the mobile device at this time. Prompt again next time this device attempts to mirror content.
- **Always block** – Never accept mirrored content from this mobile device.

**Note:** *You can manage and change the list of devices that are set to **Always allow** or **Never allow** by navigating from the Home screen menu to **Settings > System > Screen mirroring > Screen mirroring devices**.*

- If you prefer to always allow all screen mirroring attempts without prompting, go to **Settings > System > Screen mirroring**, and then change the **Screen mirroring mode** to **Always allow**.
- If you prefer to never allow screen mirroring from any device, change the **Screen mirroring mode** to **Never allow**.

For information on which devices may work with screen mirroring and instructions on how to use it, go to the following link on the Roku web site:

[go.roku.com/screenmirroring](https://go.roku.com/screenmirroring)

## Roku mobile app

Roku makes the Roku mobile app free for compatible iOS® and Android™ mobile devices.

The Roku mobile app is an alternative control center for your Roku TV, plus a way to stream Roku content while you are on the go. The Roku mobile app helps you find and add new Roku Channels, more easily search and find something to watch and even use your voice to search without typing.

Find more information and get the Roku mobile app by using the following link to the Roku web site:

[go.roku.com/mobileapp](https://go.roku.com/mobileapp)

## Private Listening on the Roku mobile app

*Only on compatible Apple and Android devices*, the Roku mobile app enables you to use headphones connected to your device to listen to streaming programs and live digital TV channels. Make sure you have the latest version of the Roku mobile app before using this feature.

For more information, go to the following link on the Roku web site:

[go.roku.com/privatelistening](https://go.roku.com/privatelistening)

## Universal remotes

In many cases, you can program your cable or satellite universal remote to also control your TV. You will need to have instructions for programming the remote handy. Check with your cable or satellite provider for instructions.

For details on how to set up the TV to work with universal remotes, go to the following link on the Roku web site:

[go.roku.com/universalremote](https://go.roku.com/universalremote)



# FAQ

For the latest answers to Frequently Asked Questions, visit the Roku support website:

[go.roku.com/support](https://go.roku.com/support)

## Legal statement

Please note—Use of the Roku TV is governed by the Roku TV End User License Agreement (see below). In addition, an end user online profile and billing account with Roku, Inc. (“Roku”) on Roku’s website (“Roku Account”) is required to stream content via the Internet using your Roku TV. A Roku Account gives you access to movies, television shows, and other audio-visual entertainment in the “Roku Channel Store,” a storefront of applications provided by Roku via your device’s on-screen menu. After your Roku Account is created, you can link your Roku TV to your account. By using the Roku TV, you agree to these statements. For the avoidance of doubt, the content disclaimer set forth herein shall refer to all content and channels accessible and available on the Roku TV, including those available via the Roku® streaming platform, as well as broadcast cable.

Due to the various capabilities of the Roku TV, as well as limitations in the available content available therein, certain features, applications, and services may not be available on all Roku TV s, or in all territories. Some features on the Roku TV may also require additional peripheral devices or membership fees that are sold separately. Please visit the Roku, Inc. website for more information on the Roku TV and content availability. The services and availability of content on the Roku TV are subject to change from time to time without prior notice.

All content and services accessible through the Roku TV belong to Roku, Inc. or third parties and are protected by copyright, patent, trademark and/or other intellectual property laws. Such content and services are provided solely for your personal noncommercial use. You may not use any content or services in a manner that has not been authorized by the content owner or service provider. Without limiting the foregoing, you may not modify, copy, republish, upload, post, transmit, translate, sell, create derivative works, exploit, or distribute in any manner or medium any content or services displayed through the Roku TV.

Third party services may be changed, suspended, removed, terminated or interrupted, or access may be disabled at any time, without notice, and Roku makes no representation or warranty that any content or service will remain available for any period of time. Content and services are transmitted by third parties by means of networks and transmission facilities over which Roku has no control. Without limiting the generality of this statement, Roku expressly disclaims any responsibility or liability for any change, interruption, disabling, removal of or suspension of any content or service made available through the Roku TV. Roku, the content providers, or the service providers may impose limits on the use of or access to certain services or content, in any case and without notice or liability. Any questions or requests for service relating to the content or services made available on the Roku TV should be submitted to the respective cable content or service provider or as described in the Roku TV User Guide.

In the event of a conflict between the Roku TV End User Agreement and the terms set forth in this Legal Statement, the Roku TV End User Agreement shall prevail and control in all circumstances.

## [Roku TV Terms of Use \(For United States\)](#)

## [Roku TV Terms of Use \(For Canada\)](#)

## [Conditions d’utilisation de Roku TV \(Pour le Canada\)](#)

### Dolby Audio™

Manufactured under license from Dolby Laboratories. Dolby, Dolby Audio, and the double-D symbol are trademarks of Dolby Laboratories Licensing Corporation. Copyright 1992-2022 Dolby Laboratories. All rights reserved.



### Dolby Vision®

Dolby, Dolby Vision, and the double-D symbol are trademarks of Dolby Laboratories. Manufactured under license from Dolby Laboratories Licensing Corporation. Confidential unpublished works. Copyright © 2013-2022 Dolby Laboratories. All rights reserved.



### HDMI®

The terms HDMI® and HDMI® High-Definition Multimedia Interface, and the HDMI® Logo are trademarks or registered trademarks of HDMI® Licensing LLC in the United States and other countries.



### Roku

ROKU, Roku TV and the Roku logo are the trademarks or registered trademarks of Roku, Inc. All other trademarks and logos herein are the property of their respective owners.



# Warranty

## LIMITED WARRANTY ONE (1) YEAR

### WARRANTY COVERAGE:

This warranty obligation is limited to the terms as set forth below.

### WHO IS COVERED:

This product warranty is issued to the original purchaser or the person receiving the product as a gift against defects in materials and workmanship as based on the date of original purchase ("Warranty Period") from an Authorized Dealer. The original sales receipt showing the product name and the purchase date from an authorized retailer is considered such proof.

### WHAT IS COVERED:

This warranty covers new products if a defect in material or workmanship occurs and a valid claim is received within the Warranty Period. At its option, the company will either (1) repair the product at no charge, using new or refurbished replacement parts, or (2) exchange the product with a product that is new or which has been manufactured from new, or serviceable used parts and is at least functionally equivalent or most comparable to the original product in current inventory, or (3) refund the original purchase price of the product.

Replacement products or parts provided under this warranty are covered against defects in materials and workmanship from the date of the replacement or repair for ninety (90) days or for the remaining portion of the original product's warranty, whichever provides longer coverage for you. When a product or part is exchanged, any replacement item becomes your property and the replaced item becomes company property. When a refund is given, your product becomes company property.

**Note:** Any product sold and identified as refurbished or renewed carries a ninety (90) day limited warranty.

Replacement product can only be sent if all warranty requirements are met. Failure to follow all requirements can result in delay.

### WHAT IS NOT COVERED - EXCLUSIONS AND LIMITATIONS:

This Limited Warranty applies only to new company manufactured products that can be identified by the trademark, trade name, or logo affixed to it. This Limited Warranty does not apply to any hardware product or any software, even if packaged or sold with the product, as manufacturers, suppliers, or publishers may provide a separate warranty for their own products packaged with the bundled product.

The company is not liable for any damage to or loss of any programs, data, or other information stored on any media contained within the product, or other additional product or part not covered by this warranty. Recovery or reinstallation of programs, data or other information is not covered under this Limited Warranty.

This warranty does not apply (a) to damage caused by accident, abuse, misuse, neglect, misapplication, or non-supplied product, (b) to damage caused by service performed by anyone other than company approved Authorized Service Location, (c) to a product or a part that has been modified without written company permission, or (d) if any serial number has been removed or defaced, or (e) product, accessories or consumables sold "AS IS" without warranty of any kind by including refurbished product sold "AS IS" by some retailers.

### This Limited Warranty does not cover:

- Shipping charges to return defective product.
- Labor charges for installation or setup of the product, adjustment of customer controls on the product, and installation or repair of antenna/signal source systems outside of the product.
- Product repair and/or part replacement because of improper installation or maintenance, connections to improper voltage supply, power line surge, lightning damage, retained images or screen markings resulting from viewing fixed stationary content for extended periods, product cosmetic appearance items due to normal wear and tear, unauthorized repair or other cause not within the control of the company.
- Damage or claims for products not being available for use, or for lost data or lost software.
- Damage from mishandled shipments or transit accidents when returning product.
- A product that requires modification or adaptation to enable it to operate in any country other than the country for which it was designed, manufactured, approved and/or authorized, or repair of products damaged by these modifications.
- A product used for commercial or institutional purposes (including but not limited to rental purposes).
- Product lost in shipment and no signature verification receipt can be provided.
- Failure to operate per User manual.

### TO OBTAIN ASSISTANCE...

Contact the Customer Care Center at:

1-833-978-3323

or chat with us via the Philips website...

REPAIR OR REPLACEMENT AS PROVIDED UNDER THIS WARRANTY IS THE EXCLUSIVE REMEDY FOR THE CONSUMER, WITH THE ISSUING COMPANY NOT LIABLE FOR ANY INCIDENTAL OR CONSEQUENTIAL DAMAGES FOR BREACH OF ANY EXPRESS OR IMPLIED WARRANTY ON THIS PRODUCT. EXCEPT TO THE EXTENT PROHIBITED BY APPLICABLE LAW, ANY IMPLIED WARRANTY OF MERCHANTABILITY OR FITNESS FOR A PARTICULAR PURPOSE ON THIS PRODUCT IS LIMITED IN DURATION TO THE DURATION OF THIS WARRANTY.

Some states do not allow the exclusions or limitation of incidental or consequential damages, or allow limitations on how long an implied warranty lasts, so the above limitations or exclusions may not apply to you.

*This warranty gives you specific legal rights. You may have other rights which vary from state/province to state/province.*

**Funai Service Corporation, 2425 Spiegel Drive, Groveport, OH 43125, USA**

# License

Funai Corporation, Inc. hereby offers to deliver, upon request, a copy of the complete corresponding source code for the copyrighted open source code packages, on an "AS IS" basis, used in this product for which such offer is requested by the respective licenses. This offer is valid up to three years after the product purchase to anyone in receipt of this information. To obtain source code, please contact Funai Corporation, Inc. You should write to Funai Service Corporation OSS Request, 2425 Spiegel Drive, Groveport, OH 43125, USA

Funai Corporation, Inc. disclaims any and all warranties and representations with respect to such software and related source code including quality, reliability, usability, and accuracy, and further disclaim all express, implied, statutory or otherwise, including without limitation, any implied warranties of title, non-infringement, merchantability, or fitness for a particular purpose. Funai Corporation, Inc. shall not be liable to make any corrections to the open source software or source code or to provide any support or assistance with respect to it. Funai Corporation, Inc. disclaims any and all liability arising out of or in connection with the use of this software and/or source code.



Funai Corporation, Inc.  
12489 Lakeland Road, Santa Fe Springs, CA 90670, USA

This product has been manufactured by and is sold under the responsibility of Funai Corporation, Inc., and Funai Corporation, Inc. is the warrantor in relation to this product.

The Philips trademark and the Philips Shield Emblem are registered trademarks of Koninklijke Philips N.V. used under license.

