

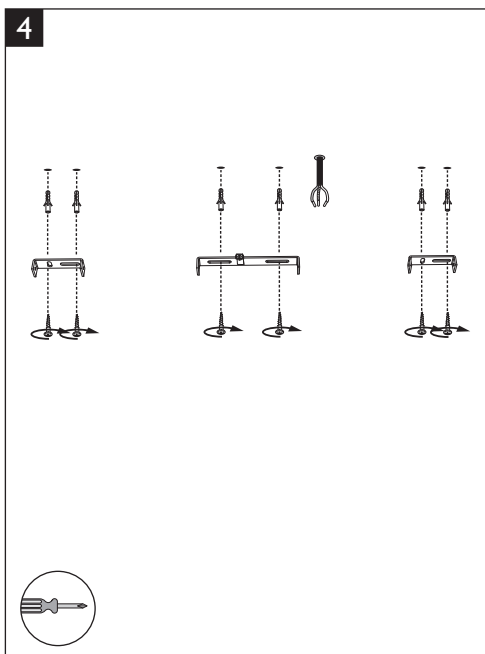

PHILIPS

4404.017.01251
Last update: 19/03/15

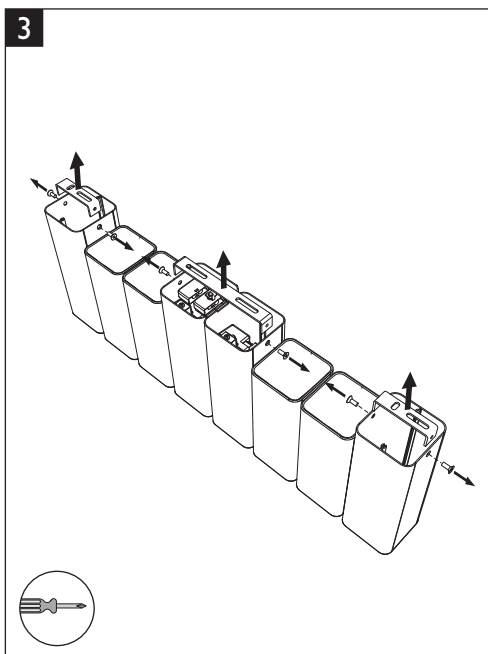
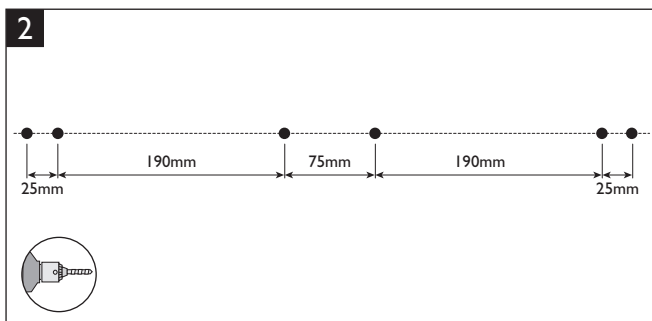
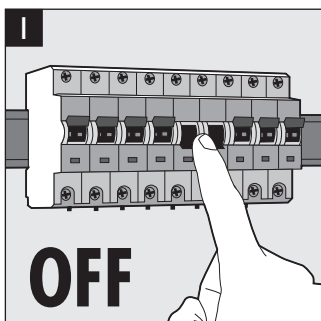
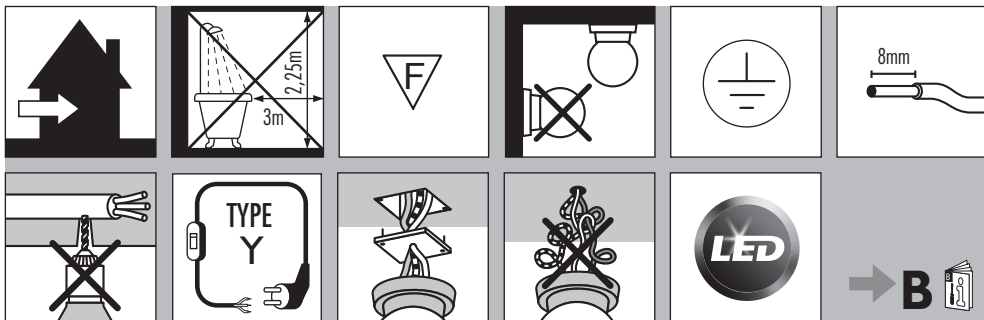

PHILIPS

