

**Return your Product Registration Card or register online at
www.philips.com/welcome today to get the very most from your purchase.**

Registering your model with PHILIPS makes you eligible for all of the valuable benefits listed below, so don't miss out. Complete and return your Product Registration Card at once, or register online at www.philips.com/welcome to ensure:

*** Proof of Purchase**

Returning the enclosed card guarantees that your date of purchase will be on file, so no additional paperwork will be required from you to obtain warranty service.

*** Product Safety Notification**

By registering your product you'll receive notification - directly from the manufacturer - in the rare case of a product recall or safety defect.

*** Additional Benefits of Product Ownership**

Registering your product guarantees that you'll receive all of the privileges to which you're entitled, including special money-saving offers.

PHILIPS

Congratulations on your purchase, and welcome to the "family!"

Dear PHILIPS product owner:

Thank you for your confidence in PHILIPS. You've selected one of the best-built, best-backed products available today. We'll do everything in our power to keep you happy with your purchase for many years to come.

As a member of the PHILIPS "family," you're entitled to protection by one of the most comprehensive warranties and outstanding service networks in the industry. What's more, your purchase guarantees you'll receive all the information and special offers for which you qualify, plus easy access to accessories from our convenient home shopping network.

Most importantly, you can count on our uncompromising commitment to your total satisfaction.

All of this is our way of saying welcome - and thanks for investing in a PHILIPS product.

P.S. To get the most from your PHILIPS purchase, be sure to complete and return your Product Registration Card at once, or register online at:

www.philips.com/welcome

**Know these
safety symbols**



This "bolt of lightning" indicates uninsulated material within your unit may cause an electrical shock. For the safety of everyone in your household, please do not remove product covering.

The "exclamation point" calls attention to features for which you should read the enclosed literature closely to prevent operating and maintenance problems.

Warning: To reduce the risk of fire or electric shock, this apparatus should not be exposed to rain or moisture and objects filled with liquids, such as vases, should not be placed on this apparatus.

CAUTION: To prevent electric shock, match wide blade of plug to wide slot, fully insert.

ATTENTION : Pour éviter les chocs électriques, introduire la lame la plus large de la fiche dans la borne correspondante de la prise et pousser jusqu'au fond.

For Customer Use

Enter below the Serial No., which is located on the rear of the cabinet. Retain this information for future reference.

Model No.

Serial No.

IMPORTANT SAFETY INSTRUCTIONS

Read before operating equipment

1. Read these instructions.
2. Keep these instructions.
3. Heed all warnings.
4. Follow all instructions.
5. Do not use this apparatus near water.
6. Clean only with a dry cloth.
7. Do not block any of the ventilation openings. Install in accordance with the manufacturers instructions.
8. Do not install near any heat sources such as radiators, heat registers, stoves, or other apparatus (including amplifiers) that produce heat.
9. Do not defeat the safety purpose of the polarized or grounding-type plug. A polarized plug has two blades with one wider than the other. A grounding type plug has two blades and third grounding prong. The wide blade or third prong are provided for your safety. When the provided plug does not fit into your outlet, consult an electrician for replacement of the obsolete outlet.
10. Protect the power cord from being walked on or pinched particularly at plugs, convenience receptacles, and the point where they exit from the apparatus.
11. Only use attachments/accessories specified by the manufacturer.
12.  Use only with a cart, stand, tripod, bracket, or table specified by the manufacturer, or sold with the apparatus. When a cart is used, use caution when moving the cart/apparatus combination to avoid injury from tip-over.
13. Unplug this apparatus during lightning storms or when unused for long periods of time.
14. Refer all servicing to qualified service personnel. Servicing is required when the apparatus has been damaged in any way, such as power-supply cord or plug is damaged, liquid has been spilled or objects have fallen into apparatus, the apparatus has been exposed to rain or moisture, does not operate normally, or has been dropped.
15. This product may contain lead or mercury. Disposal of these materials may be regulated due to environmental considerations. For disposal or recycling information, please contact your local authorities or the Electronic Industries Alliance: www.eiae.org.
16. Damage Requiring Service - The appliance should be serviced by qualified service personnel when:
 - A. The power supply cord or the plug has been damaged; or
 - B. Objects have fallen, or liquid has been spilled into the appliance; or
 - C. The appliance has been exposed to rain; or
 - D. The appliance does not appear to operate normally or exhibits a marked change in performance; or
 - E. The appliance has been dropped, or the enclosure damaged.
17. Tilt/Stability - All televisions must comply with recommended international global safety standards for tilt and stability properties of its cabinets design.
 - Do not compromise these design standards by applying excessive pull force to the front, or top, of the cabinet which could ultimately overturn the product.
 - Also, do not endanger yourself, or children, by placing electronic equipment/toys on the top of the cabinet. Such items could unsuspectingly fall from the top of the set and cause product damage and/or personal injury.
18. Wall or Ceiling Mounting - The appliance should be mounted to a wall or ceiling only as recommended by the manufacturer.
19. Power Lines - An outdoor antenna should be located away from power lines.
20. Outdoor Antenna Grounding - If an outside antenna is connected to the receiver, be sure the antenna system is grounded so as to provide some protection against voltage surges and built up static charges. Section 810 of the National Electric Code, ANSI/NFPA No. 70-1984, provides information with respect to proper grounding of the mats and supporting structure grounding of the lead-in wire to an antenna-discharge unit, size of grounding connectors, location of antenna-discharge unit, connection to grounding electrodes and requirements for the grounding electrode. See Figure below.
21. Objects and Liquid Entry - Care should be taken so that objects do not fall and liquids are not spilled into the enclosure through openings.
 - a) Warning: To reduce the risk of fire or electric shock, this apparatus should not be exposed to rain or moisture and objects filled with liquids, such as vases should not be placed on this apparatus.
22. Battery Usage CAUTION - To prevent battery leakage that may result in bodily injury, property damage, or damage to the unit:
 - Install all batteries correctly, with + and - alignment as marked on the unit.
 - Do not mix batteries (old and new or carbon and alkaline, etc.)
 - Remove batteries when the unit is not used for a long time.

EXAMPLE OF ANTENNA GROUNDING AS PER NATIONAL ELECTRICAL CODE (NEC)

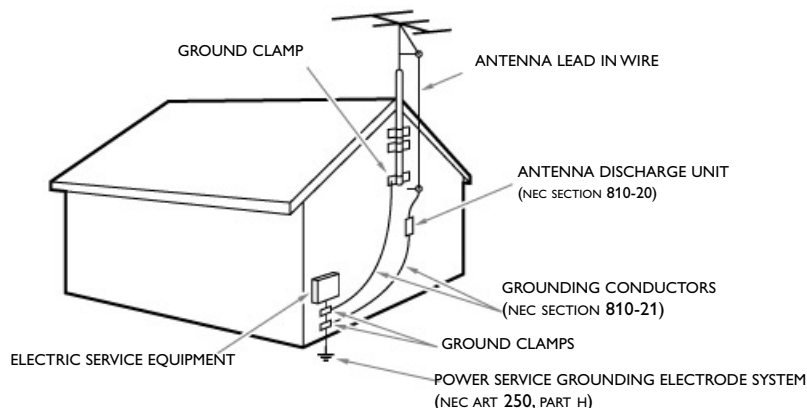

Note to the CATV system installer: this reminder is provided to call the CATV system installer's attention to Article 820-40 of the NEC that provides guidelines for proper grounding and, in particular, specifies that the cable ground shall be connected to the grounding system of the building, as close to the point of cable entry as practical.

Content

1 Safety warnings	2	11 To connect and operate accessory devices	23
1.2 Care of the screen	2	11.1 Side panel overview	23
1.3 Warning concerning stationary images on the TV screen ...	2	11.2 To make video and audio connections	24
1.4 Mounting	2	11.3 Connect a recorder (VCR / DVD-R)	25
1.5 Electric, Magnetic and Electromagnetic Fields	2	11.4 Connect a recorder and a second A/V device	25
1.6 Pixel characteristics	3	11.5 Connect a DVD player/recorder, Set top box, gameconsole,... with a HDMI connector	25
1.7 VESA Compliance Information for Professional Installation ...	3	11.6 Connect a DVD player/recorder, Set top box, gameconsole,... with a DVI connector	25
1.8 Kensington Security Slot	3	11.7 Connect a DVD player with a S-VIDEO connector	26
2 Getting started	4	11.8 Connect a recorder and Set top cable box with RF output	26
2.1 Connection overview	4	11.9 Connect a satellite receiver or Set top cable box with A/V outputs	26
3 Use of the Remote Control RC 2033601/01	6	11.10 Connect a satellite receiver or Set top box and a recorder with A/V outputs	26
3.1 Use of the OPTION button	7	11.11 Connect digital source devices with Video Component Output connectors (YPbPr)	26
3.2 Picture format	7	11.12 Connect a Home theater amplifier	27
3.3 Buttons on the left of the TV	7	11.13 Connect a PC	27
3.4 Turn the TV on	7	12 Problems	28
4 First time installation	8	13 Glossary	29
5 How to navigate through the menus	9	14 Recycling	29
5.1 Introduction	9	15 Product information	29
5.2 Use of the TV menu settings	9	Annex	
5.2.1 Adjust viewing and listening settings	9	1 - Philips TV Slideshow Format with background music	30
5.2.2 Adjust Picture menu settings	10	2 - Philips TV - Digital camera and USB issues	31
5.2.3 Adjust Sound menu settings	11	3 - Issues referring to connected peripherals with a HDMI connector	32
6 Adjust feature menu settings	12	4 - Software update	33
6.1 Closed captions	12	Index	35
6.2 Caption service	12		
6.3 Digital caption service	13		
6.4 Digital caption options	13		
6.5 Sleeptimer	13		
6.6 Child lock	13		
6.7 Set/Change PIN	15		
6.8 On timer	16		
6.9 Demo	16		
7 How to search for and store TV channels	16		
7.1 Installation menu	16		
7.2 Select your language	16		
7.3 Store TV channels	17		
7.4 Set your preferences	18		
7.5 Select your connections	19		
7.6 Set your clock	19		
7.7 Reset AV settings	20		
8 Create your favorite list	20		
8.1 Select a channel from the displayed list	20		
8.2 Select another favorite channel list	20		
8.3 Create or modify a favorite list	20		
9 Electronic Program Guide	21		
10 Multimedia browser	21		
10.1 To view content from a USB device	21		
10.2 Multimedia Browser menu	21		



Manufactured under license from Dolby Laboratories. 'Dolby' 'Pro Logic' and the double-D symbol are trademarks of Dolby Laboratories.

HD programming

You must get HD programming to get an HD picture !
Call your Cable or Satellite service to order HDTV Programming.

1 Safety warnings

1.1 General

❗ Do not insert the power plug in a wall socket or hang the TV to the wall before all connections are made.

- Place or hang the TV wherever you want, but make sure that air can circulate freely through the ventilation slots. Leave at least 4" to 6" free all around the TV.
- Do not place the TV on a carpet.

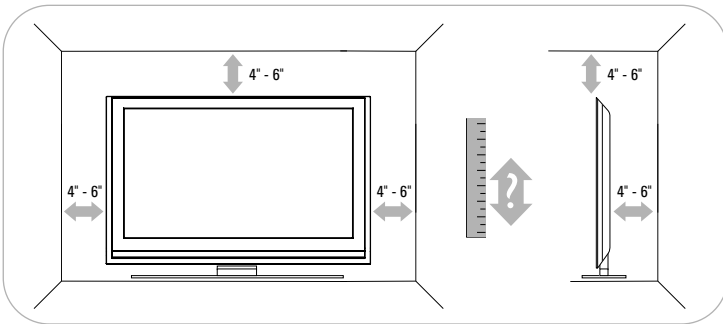

- Do not install the TV in a confined space such as a book case or a similar unit.
- To prevent any unsafe situations, no naked flame sources, such as lighted candles, should be placed in the vicinity.
- Avoid heat, direct sunlight and exposure to rain or water.
- The equipment shall not be exposed to dripping or splashing.
- To prevent damaging the power (AC) cord which could cause a fire or electric shock, do not place the TV on the cord.

1.2 Care of the screen

Do not remove the protective sheet until you have completed the stand/wall mounting and connection.

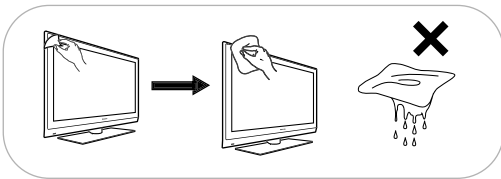

Please, handle with care. Use only a soft cloth to clean the glossy black front of the TV.

Do not touch, push or rub or strike the screen with anything hard as this may scratch, mar or damage the screen permanently.

And please do not rub with dust clothes with chemical treatment.

Do not touch the surface with bare hands or greasy cloth (some cosmetics are detrimental to the screen). Unplug the TV before cleaning the screen.

When the surface becomes dusty, please wipe gently with absorbent cotton or other soft materials like chamois soaks. Do not use acetone, toluene and alcohol because they cause chemical damage. Do not use liquid cleaners or aerosol cleaners. Wipe off saliva or water drops as soon as possible. Their long time contact with the screen causes deformations and color fading.

1.3 Warning concerning stationary images on the TV screen

A characteristic of LCD Panels is that displaying the same image for a long time can cause a permanent after-image to remain on the screen. Normal use of the TV should involve the showing of pictures that contain constantly moving and changing images that fill the screen. Examples of stationary images (this is not an all-inclusive list, you may encounter others in your viewing):

- TV menus;
- Black bars: when black bars appear at the left and right side of the screen, it is recommended to change to a picture format so that the picture fills the entire screen;
- TV channel logo: present a problem if they are bright and stationary. Moving or low-contrast graphics are less likely to cause uneven aging of the screen;
- Stock market stickers: presented at the bottom of the TV screen;
- Shopping channel logos and pricing displays: bright and shown constantly or repeatedly in the same location on the TV screen. Examples of still pictures also include logos, computer images, time display, teletext and images displayed in 4:3 mode, static images or characters, etc.

❗ Reduce contrast and brightness when viewing. When the same image is displayed for 10 minutes, brightness will be reduced automatically. Once burn-in occurs it will never disappear completely.

❗ Carefully pay attention to these remarks. The warranty does not apply to damage caused by not taking into account the above mentioned warnings on stationary images.

1.4 Mounting

Installing the TV requires special skills that should only be performed by qualified personnel. You should not attempt to do the work yourself. Philips bears no responsibility for improper mounting or mounting that results in accident or injury. Make sure that the wall mount is being fixed securely enough so that it meets safety standards.

❗ If the TV is mounted on a swivel base or swivel arm, ensure no strain is placed on the power cord when the TV is swivelled. Strain on the power cord can loosen connections. This may cause arcing and result in fire.

1.5 Electric, Magnetic and Electromagnetic Fields (EMF)

- Philips Royal Electronics manufactures and sells many products targeted at consumers, which, like any electronic apparatus, in general have the ability to emit and receive electromagnetic signals.
- One of Philips' leading Business Principles is to take all necessary health and safety measures for our products, to comply with all applicable legal requirements and to stay well within the EMF standards applicable at the time of producing the products.
- Philips is committed to develop, produce and market products that cause no adverse health effects.
- Philips confirms that if its products are handled properly for their intended use, they are safe to use according to scientific evidence available today.
- Philips plays an active role in the development of international EMF and safety standards, enabling Philips to anticipate further developments in standardization for early integration in its products.

1.6 Pixel characteristics

Your TV display is made with high-precision technology with a high number of color pixels. Although it has effective pixels of 99,999% or more, black dots or bright points of light (red, green or blue) may appear constantly on the screen. This is a structural property of the display (within common industry standards) and is not a malfunction.

1.7 VESA Compliance Information for Professional Installation

⚠ Caution

Consult a Home Theater installation professional. Improper mounting could result in severe injury or damage. Koninklijke Philips Electronics NV bears no responsibility for improper mounting or mounting that results in accident or injury.

Your TV is prepared for VESA compliant wall mounting. This bracket is not included. Use a VESA compliant bracket with code VESA MIS-F, 600, 400, M8. Consult your dealer for more information.

- 1 Locate the VESA screwholes on the back of the TV.

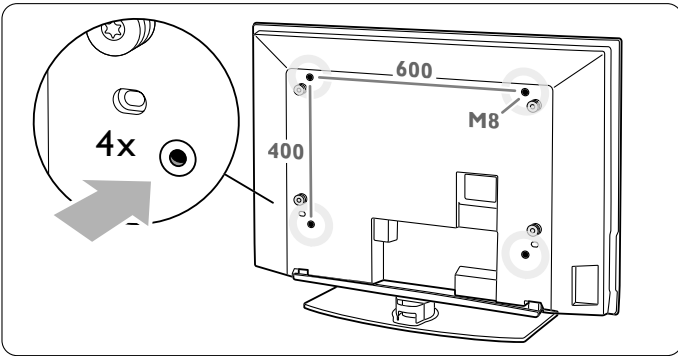

- 2 Should the plastic discs obstruct the VESA bracket, you can unscrew these 4 discs.

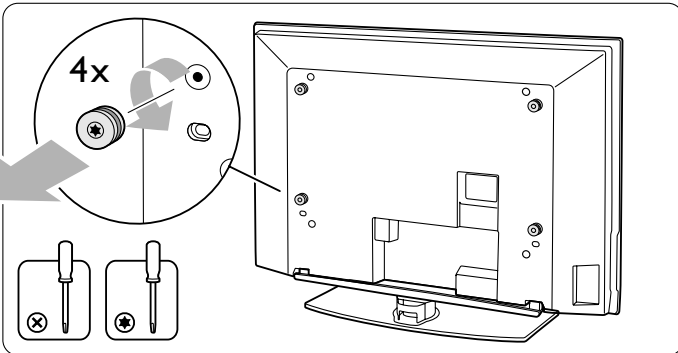

VESA, FDMI and the VESA Mounting Compliant logo are trademarks of the Video Electronics Standards Association.

1.8 Kensington Security Slot (if present)



Your TV is equipped with a Kensington Security Slot, to prevent it from getting stolen.

An anti-theft Kensington lock has to be purchased separately. The Kensington lock is a plastic-coated steel cable with a lock. One end has to be fixed to the opening of the TV and locked with a special button. The other end is attached to a fixed point.

® Kensington and MicroSaver are registered US trademarks of ACCO World Corporation with issued registrations and pending applications in other countries throughout the world. All other registered and unregistered trademarks are the property of their respective owners.

2 Getting started

Welcome to the growing family of owners of Philips.

⊕ Before installing your TV or before hanging it on the wall, first connect your accessory devices.

⚠ Do not insert the power plug into the mains at the bottom of the TV and in a wall socket before all connections are made.

2.1 Connection overview

There is a wide range of audio and video devices that can be connected to your TV. See Chapter 11 **How to connect and operate accessory devices**.

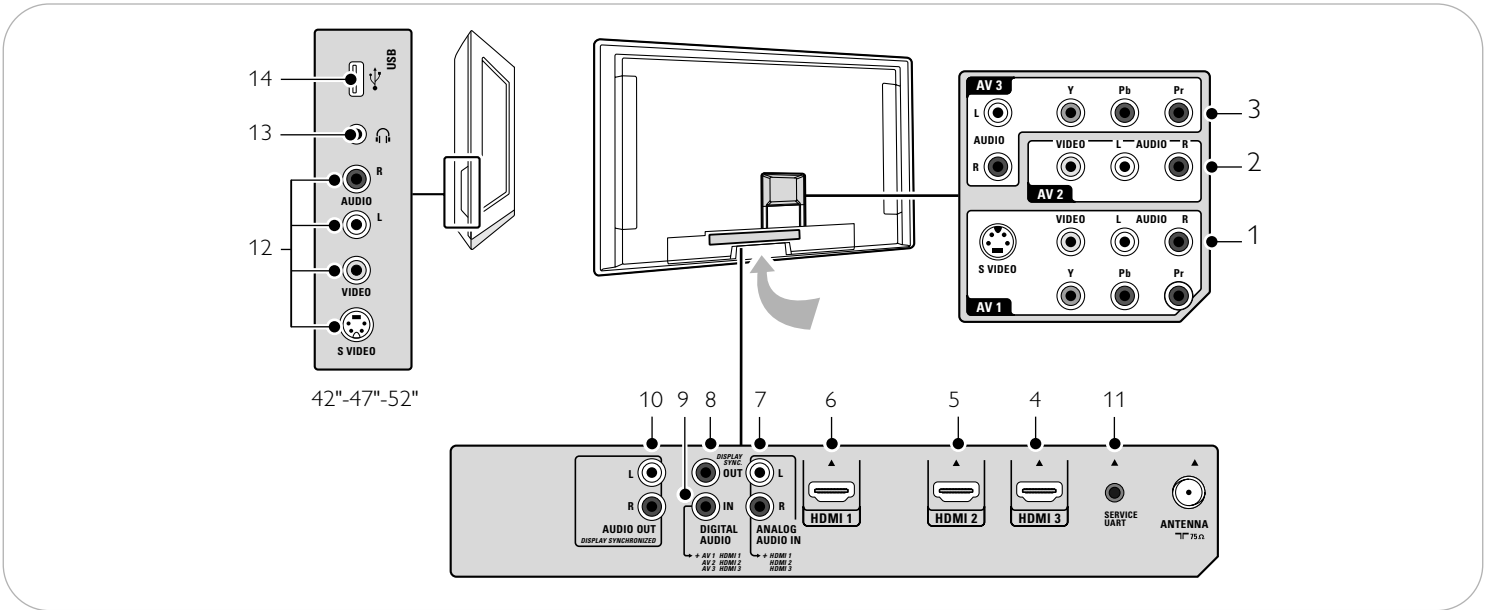

2.1.1 Back connections

1-2-3 AV1 - AV2 - AV3

- To connect devices with
- an S-Video connector and L and R audio cables
 - devices with 3 separate Component Video Output connectors (YPbPr) and Analog L and R audio cables
 - devices with Video and Audio L and R AV cables.

4-5-6 HDMI *

To connect a device with a HDMI connector. If the accessory device has a DVI output only, see Chapter 11.7.

7 Analog Audio In L/R

Analog audio for devices connected to a HDMI connector.

8 Digital Audio Out

To connect a digital Home theater amplifier.

9 Digital Audio In

10 Audio Out L/R

11 Service UART

For use only by authorized service personnel.

⚠ **For installers/integrators:** Do not connect RS232 without level shifter.

2.1.2 Side connections

12 To connect devices with Video or S-Video and Audio Left and Right AV cables.
(For ex. camera, camcorder, game, audio,...)

13 To connect your headphone.

14 To connect a USB device.

* According to your type of set, 2 or 3 HDMI connectors are available.

2.1.3 Connect to the TV

Your Philips Digital TV will allow you to enjoy digital programs directly from your cable or off air. Connect directly to the TV or connect via your current cable box or Satellite Receiver box.

2.1.3.1 Directly to the TV (you will not be able to receive pay channels)

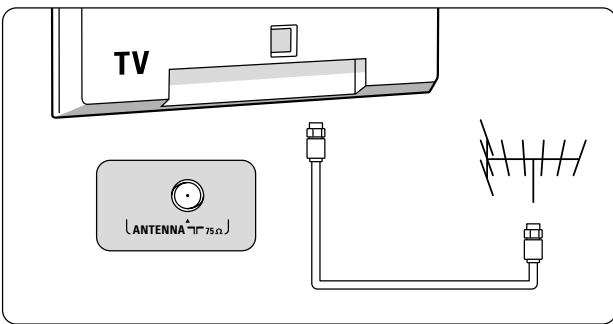

- 1 Connect the cable TV signal or the incoming antenna signal to the **ANTENNA 75Ω** jack at the bottom of the TV.
 - 2 See Chapter 7.3 **Store TV channels** for details on using Autoprogram to store channels in the TV's memory.
- ⓘ Broadcasters are in the middle of a transition from analog to digital TV. This means that a given broadcaster will have two channels on the air; one analog and one digital.
- This connection will supply stereo sound to the TV if it is being broadcast by the station you are watching.

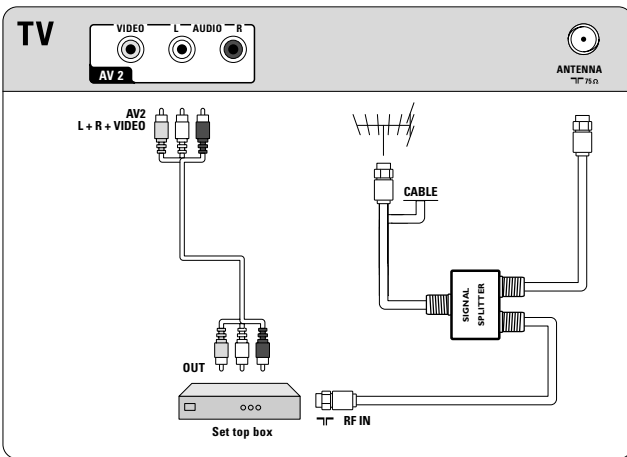

2.1.3.2 Via a cable box or Satellite box

- 1 Maintain the connection of the TV cable of your home into your cable box (or satellite receiver box).
 - 2 Connect your Cable box (or satellite receiver box) to the back of the TV using the best connection options. See Chapter 11.2 **To make audio and video connections**.
 - 3 Select the source using the **SOURCE** button on the remote control.
 - 4 Press the **OK** button to confirm your selection.
- ⓘ For more information, please refer to your cable box (or satellite receiver box) manual.

ⓘ Watching Cable TV programs that don't require the cable box

Since you've connected the cable TV signal directly to the TV's tuner, you can also watch the unscrambled programs by simply tuning to the desired channel. You must first use Autoprogram, however, to store channels in the TV's memory. See Chapter 7.3. This connection will supply stereo sound to the TV if it is being broadcast by the station you are watching.

2.1.4 Connect the mains

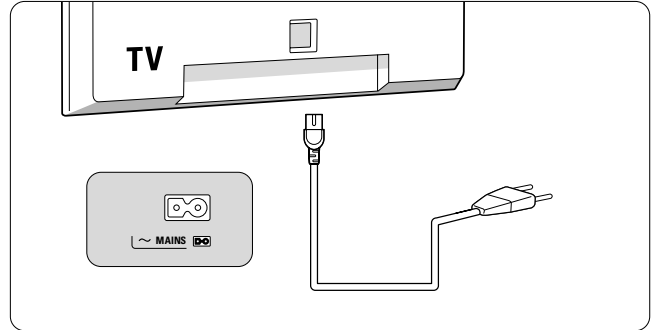

- ⓘ Verify that the power supply voltage corresponds to the voltage printed on the sticker at the back of the TV. Contact your local dealer if your power supply is different.
- ⓘ Ensure the power cord is fully inserted in the TV mains socket and the wall socket.

2.1.5 Remote control

Insert the 2 batteries supplied (Type R03-1,5V). Be sure the (+) and (-) ends of the batteries line up correctly (inside of case is marked.)

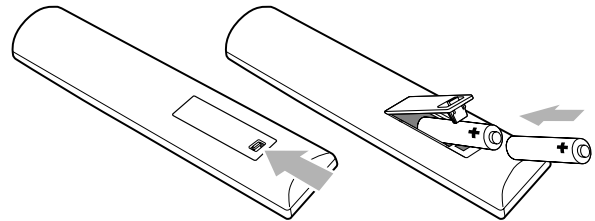

3 Use of the remote control RC 2033601/01

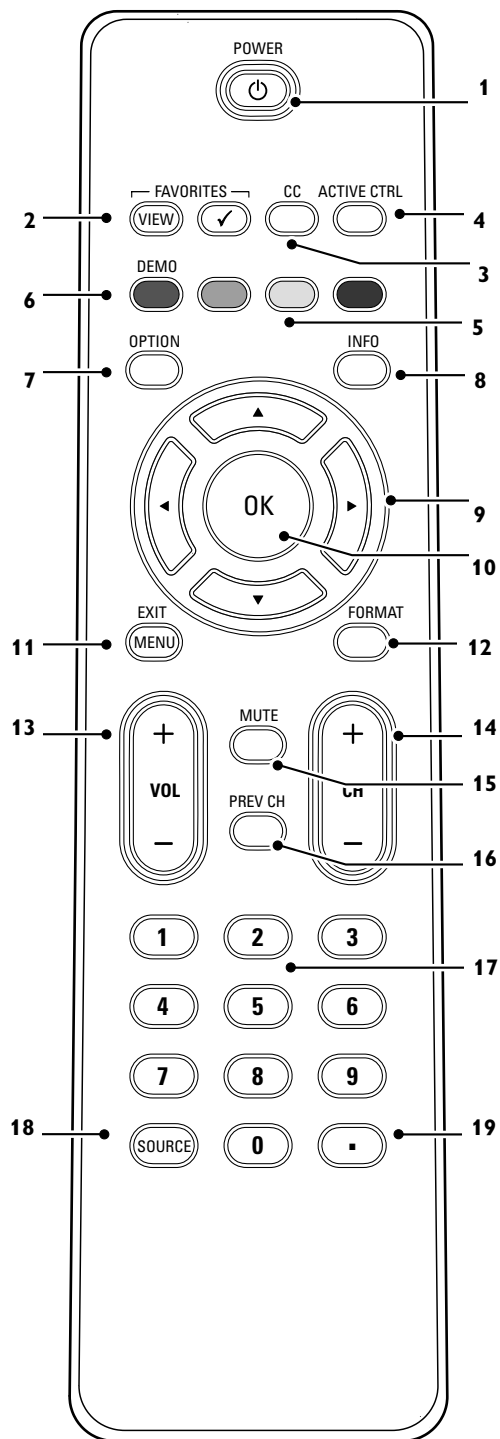

Due to the sensitivity of the remote control, you may experience a delayed operation at start up of the TV. After a short while your remote control will work smoothly.

- 1 **POWER** Press to turn the TV on/off.
- 2 **FAVORITES**
 - **VIEW** To display the last selected list. You can create up to four favorite lists. See Chapter 8 **Create your favorite list.**
 - ✓ No function
- 3 **CC** Select On, off or On during mute to activate/de-activate Closed Captions. See Chapter 6.1 **Closed Captions.**
- 4 **ACTIVE CTRL** Press to select Active Control on/off. See Chapter 5.2.2 **Adjust picture menu settings.**
- 5 **Color buttons** When functions are attached to the color buttons, the color buttons are shown on screen.
- 6 **DEMO** Demo on/off.
- 7 **OPTION** To open and close the Quick access menu which contains a few frequently used options, like Closed captions, Picture format,... See Chapter 3.1 **Use of the Option button.**
- 8 **INFO**
 - Display information:** Press to display (when available) information about the selected TV channel and program or accessory device. The quality and accuracy of the information on the information banner are transmitted from broadcasters. You may see a difference in broadcast time if the broadcaster is from a different time zone area.
 - Display clock:** Select to activate/de-activate the clock display on the screen.
- 9 **Cursor buttons** Press the cursor buttons up/down, left/right to navigate through the menus.
- 10 **OK**
 - To activate a setting.
 - To display the list of channels stored (according to the selection made in the Installation mode - Antenna or Cable, see Chapter 7.3 **Store TV channels**).
 - Starts playing content in the Multimedia Browser application. See Chapter 10 **Multimedia browser.**
- 11 **MENU/EXIT** Settings menu on/off. See Chapter 5.2 **Use of the TV menu settings.**
- 12 **FORMAT** See Chapter 3.2 **Picture format.**
- 13 **VOLUME** Press + or - to adjust the volume.
- 14 **Channel selection**
 - To browse through the TV channels or sources stored and marked in the selected Favorite channels list. See Chapter 8 **Create your favorite list**;
 - To quickly browse through the list in the menus;
 - To select between Antenna or Cable TV channels, first make your selection in the Installation menu, Channel installation, Installation mode, see Chapter 7.3 **Store TV channels.**
- 15 **MUTE** Interrupt the sound or restore it.
- 16 **PREV CH** Press to alternate between the currently viewed channel and the previously viewed channel.
- 17 **Numeric buttons** To select a TV channel.
- 18 **SOURCE** Press repeatedly to select **AV1, AV2, AV3, HDMI 1, HDMI 2, HDMI 3, Side** or **TV channels** according to where you connected the accessory devices.
- 19 - Type the dot (•) for digital channels.

3.1 Use of the OPTION button

The **OPTION** button allows you to display the Quick access menu which will give you direct access to some features and menu options.

- 1 Press the **OPTION** button.
 - The Quick access menu appears.

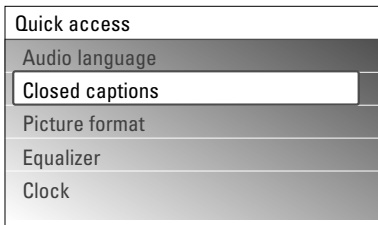

- 2 Press the cursor up/down to select a menu item.
- 3 Press the **OK** button to jump to the selected menu item in the TV menu (except for the clock option).
- 4 Use the cursor buttons to make a selection.
- 5 Press the **OPTION** button to exit.

Audio language

See Chapter 5.2.3 Adjust Sound menu settings.

Closed captions

See Chapter 6 Adjust Feature menu settings.

Picture format

See Chapter 5.2.2 Adjust Picture menu settings, or Chapter 3.2 Picture format.

Equalizer

See Chapter 5.2.3 Adjust Sound menu settings.

Clock

Select to activate/deactivate the clock display on the screen.

3.2 Widescreen picture format

Avoid black bars on the sides or on top and bottom of the picture. Change the picture format to a format that fills the screen.

- 1 Press **FORMAT** to switch on the Picture format menu.
- 2 Press **▲** or **▼** to select an available picture format.
- 3 Press **▲** to shift the picture upwards to make partly covered subtitles visible.

Tip

The format Automatic is recommended for minimal distortion.

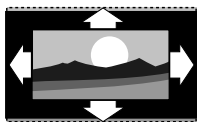

Automatic (Not for PC.)
Enlarges the picture automatically to fill the screen. Subtitles remain visible.

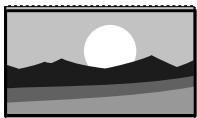

Super zoom (Not for HD.)
Removes the black bars on the side of 4:3 broadcasts. There is a minimal distortion.



4:3 (Not for HD.)
Shows the classical 4:3 format.

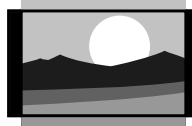

Movie expand 14:9 (Not for HD.)
Scales classical 4:3 format to 14:9.



Movie expand 16:9 (Not for HD.)
Scales classical 4:3 format to 16:9.

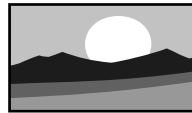

Wide screen
Stretches 4:3 format to 16:9.



Unscaled (Only for HD and PC.)
Maximum sharpness. Distortion may appear on borders. Black bars may appear with pictures from your PC.

Note

Do not forget to name the connection in the Connections menu. See chapter 7.5 Select your connections.

3.3 Buttons on the left of the TV

Should your remote be lost or broken you can still change some of the basic settings with the buttons on the left side of your TV.

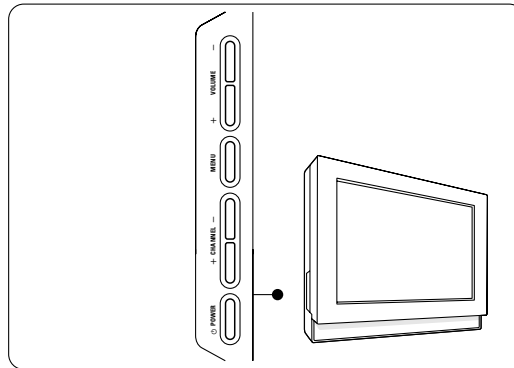

Press the **POWER** button to turn the TV on.

The **MENU** button can be used to summon or exit the TV menu without the remote control.

Use the **VOLUME +** and **-** buttons to adjust the volume.

Use the **CHANNEL +** and **-** buttons to browse through the TV channels and sources stored and marked in the Favorite channel lists.

3.4 Turn the TV on

- Press the **POWER** button at the left side of the TV.
 - An indicator on the front of the TV lights up.
- Press the **+ CH -** button or the **POWER** button on the remote control.

ⓘ The first time (and only the first time) you turn on your TV, you see a welcome screen followed by the installation procedure. See Chapter 4 First time installation.

4 First time installation

The installation procedure consists of a series of screens that will guide you through the installation of your TV. Follow the instructions on screen.

- ❗ If the TV has already been installed before and/or you want to change the First time installation settings, proceed with Chapter 5.2 **Use of the TV menu settings**.

Step 1 - Select your on-screen language

After the Welcome screen you are asked to select a language of the TV's on-screen menus. The text of the header and the info on screen continuously change language.

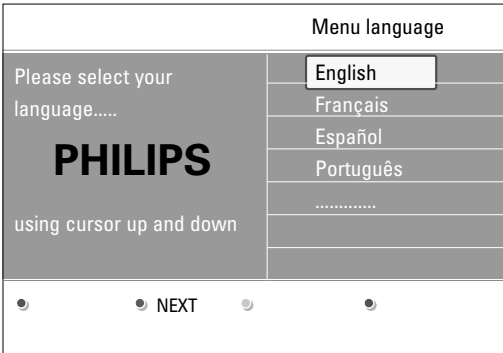

- 1 Press the cursor up/down to highlight your language.
- 2 Press the **OK** button on the remote control.
- 3 Follow the instructions on screen to proceed.

Step 2 - Complete the initial TV installation procedure

- 1 Press the green color button on your remote control to start the television installation.

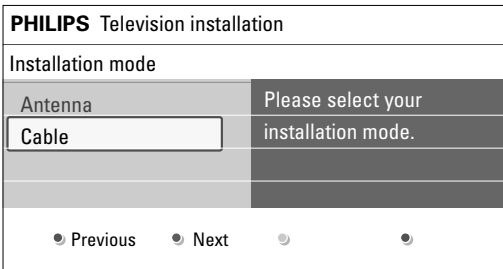

- 2 Select **Cable** or **Antenna** in the Installation mode and press the green color button.
 - ▷ When **Antenna** is selected, the TV will detect antenna signals and will search for antenna TV (NTSC and ATSC) channels available in your local area.
 - ▷ When **Cable** is selected, the TV will detect cable company supplied signals and will search for cable TV (NTSC, ATSC, QAM modulated) channels available in your area.
- 3 Press the green color button on your remote control to start the Automatic channel installation.
 - ▷ All available TV channels are searched for and stored automatically. This will take a few minutes. When the search is complete, the menu will indicate the number of digital and analog channels found.
- ❗ If you choose to install the channels at a later time, see Chapter 7.3 **Store TV channels** to select Autoprogram to scan available channels.
- 4 Press the red color button when the search is completed.

Step 3 - Settings assistant: select your TV settings

The Settings assistant will help you to select your preferred picture and sound settings. Finally you will arrive at a complete setting which satisfies you.

- 1 Press the green color button on your remote control to enter the **Settings assistant** menu.



- 2 Select your location with the cursor up/down.

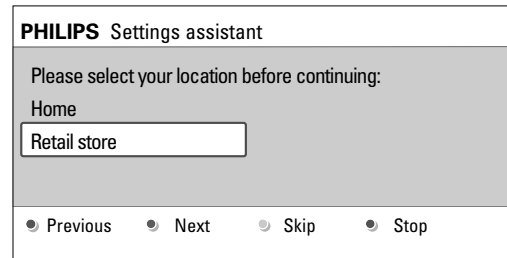

- ▷ If you choose **Home** it will start display the Settings assistant.
 - ▷ If you choose **Retail store** it will skip the Settings assistant. The TV parameters for Picture and Sound will then be set to predefined fixed settings.
- 3 Press the green color button again to proceed.
 - 4 Use the cursor left/right to each time select your preferred screen.
 - 5 Press the green color button to each time confirm your selection and to jump to the following screen.
 - ▷ The following items will be presented sequentially. In the header it is mentioned how many screens have been completed and how many screens there are in total.
 - 6 When finished, press the green color button twice to store all the settings and to return to the TV installation menu.
 - ❗ When you skip or stop the Settings Assistant, the Standard settings Philips selected for you will be chosen.
 - 7 Press the red color button to finish the First time installation procedure and to display the first stored TV channel.
 - ❗ At any time you can change or reset your settings or adjust individual settings for Picture and Sound in the TV Settings menu. See Chapter 5.2.1 **Adjust viewing and listening settings**. To control the settings of special TV functions, features and accessory devices, see Chapter 6 **Adjust Feature menu settings**.

5 How to navigate through the menus

5.1 Introduction

A lot of guiding instructions, help texts and messages will be displayed on your TV when you use the menus or when you try to execute an action. Read the help texts which are being displayed on the specific item highlighted.

The color buttons at the bottom of the screen refer to the different actions which may be executed.

Press the corresponding color button on the remote control to perform the required or desired action.

- 1 Press the **MENU** button on the remote control.

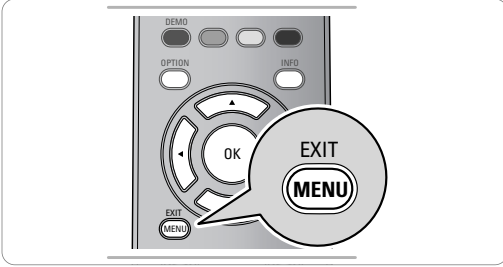

- ▷ The main menu appears on the screen.

Television	TV menu
	Channel list
	Program guide
Multimedia	USBdevice 1

- **TV menu** allows you to access the TV menu. See below.
- **Channel list** allows you to access the TV channel list and to create up to four favorite lists with your preferred TV channels. See Chapter 8 - **Create your favorite channel list**.
- **Program guide** allows you to access detailed information about individual digital TV programs.
- **Multimedia** allows you to access the Multimedia browser application. It lets you display your personal multimedia (pictures, audio) files. Multimedia is only present when a USB device is connected. See Chapter 10 **Multimedia browser**.

- 2 Use the cursor up/down to highlight and select a menu item.
- 3 Use the cursor right to enter the highlighted menu item.
 - ▷ The right panel shows the content of the highlighted menu item.
- 4 Use the cursor up/down to select a menu item.

TV menu	TV settings
TV settings	Settings assistant
Features	Reset to standard
Installation	Picture
Software update	Sound
Info	

- **TV settings** allows you to adjust your preferred picture and sound settings
- **Features** allows you to control the settings of special TV features
- **Installation** allows you
 - to select your menu language;
 - to search for and store your TV channels;
 - to do a weak ATSC digital channel installation;
 - to set or adjust various special functions;
 - to select connected peripheral equipment;

- to reset your picture and sound settings to the factory standard settings;
- to update your TV software.
- **Software update** allows you to update your current software.

- 5 Press the cursor right to enter the highlighted menu item.
 - ▷ The content of the right panel is moved to the left panel and the right panel now shows the content of the newly highlighted item in the left panel.

- 1 In some cases it is important that the picture can be watched while you adjust the settings. This means that when the highlight is on the right side panel, the other menu items hide away. When the cursor left is pressed, the hidden menu items reappear and the highlight moves to the left panel.

- 6 Press the **MENU** button to exit the main menu.

5.2 Use of the TV menu settings

The TV menu allows you to access and change settings and preferences in case you want to change the First time installation settings and/or you want to control the settings of special TV functions, features and peripheral equipment.

5.2.1 Adjust viewing and listening settings

- 1 Press the **MENU** button on the remote control.
 - ▷ The main menu appears on the screen.

Television	TV menu
	Channel list
	Program guide
Multimedia	USBdevice 1

- 2 Select **TV menu** and press the cursor right.
 - ▷ The TV menu is displayed.

TV menu	TV settings
TV settings	Settings assistant
Features	Reset to standard
Installation	Picture
Software update	Sound
Info	

- 3 Select **TV settings** and press the cursor right.
 - ▷ The TV settings menu is moved to the left.
- 4 Press the **MENU** button to exit the menu.

To make it easier to change the settings of the TV, there are 3 ways of doing it. See further.

A. Change settings in an easy-to-use manner with the Settings assistant

Each time you've made a selection, press the green color button to confirm your selection.

- 1 Select **Settings assistant** and press the cursor right.
 - ▷ By means of several split screens/full screens you are prompted to select your preferred picture and sound settings to finally arrive at a complete setting which satisfies you. See Chapter 4 **First time installation, Step 3 - Settings assistant**.
- 2 Press the green color button to return to the TV menu again.

B. Use of the Standard settings

This allows you to reset your settings for viewing and listening to predefined factory settings.

- 1 Select **Reset to standard** and press the cursor right.
 - ▷ A menu appears which allows you to select one of the standard settings for viewing and listening.

TV menu	
TV settings	Reset to standard
Settings assistant	Current
Reset to standard	Natural
Picture	Vivid
Sound	Movie
Info	

- **Current** shows your current settings for viewing and listening.
 - If you select **Natural**, it allows you to set your picture and sound settings to the recommended standard values. In most cases this will give the best balanced viewing experience.
 - If you select **Vivid**, it allows you to set your picture and sound settings to rich values, making use of the TV capabilities to its full extend.
 - If you select **Movie**, it allows you to set your picture and sound settings to the purest representation of the original source content.
- 2 Press the green color button to store the selected setting.

C. Individual settings for picture and sound

- Select Picture or Sound and press the cursor right.
 - ▷ A menu appears which allows you to fine tune the picture and sound settings.
 - ▷ To adjust the Picture settings, see Chapter 5.2.2 **Adjust picture menu settings**.
 - ▷ To adjust the Sound settings, see Chapter 5.2.3 **Adjust sound menu settings**.

5.2.2 Adjust Picture menu settings

The picture menu contains the settings that affect the quality of the picture.

- 1 Press the **MENU** button on the remote control.
 - ▷ The main menu appears.
- 2 Select **TV menu** and press the cursor right.
 - ▷ The TV menu is moved to the left.
- 3 Select **TV settings** and press the cursor right.
 - ▷ The TV settings menu is moved to the left panel.
- 4 Select **Picture** and press the cursor right.
 - ▷ The Picture menu is moved to the left panel.
- 5 Use the cursor up/down to select the Picture menu items.
- 6 Press the cursor right to enter the selected Picture menu item.
- 7 Use the cursor buttons to adjust the settings.
- 8 Press the cursor left to return to the Picture menu.

TV menu	
TV settings	Picture
Settings assistant	Contrast
Reset to standard	Brightness
Picture	Color
Sound	Tint
	Sharpness
	Color temperature
	Perfect Pixel HD
	120 Hz Clear LCD
	Dynamic contrast
	Noise reduction
	MPEG artefact reduction
	Color enhancement
	Active Control
	Light sensor
	Picture format
Info	

Contrast

Adjusts the intensity of bright parts in the picture but keeps the dark parts unchanged.

Brightness

Adjusts the light output of the complete picture, which will mainly affect the darker areas of the picture.

Color

Adjusts the saturation level of the colors to suit your personal preference.

Tint

Allows you to select the color mix (tint) of the picture.

Sharpness

Adjusts the sharpness of fine details in the picture.

Color temperature

Increases or decreases **Warm** (red) and **Cool** (blue) colors to suit personal preferences.

- Select **Cool** to give the white colors a blue, **Normal** to give the white colors a neutral, **Warm** to give the white colors a red tint.
- Select **Custom** to make customized settings.

- 1 Press the green color button.

- ▷ The **Custom color temperature** screen appears. This allows you to fine tune the white point (**WP**) and black level (**BL**) of the picture.

- 2 Use the cursor buttons to select and adjust the settings of:
 - R-WP**: allows you to customize the color temperature by adjusting the red whitepoint of the picture.
 - G-WP**: allows you to customize the color temperature by adjusting the green whitepoint of the picture.
 - B-WP**: allows you to customize the color temperature by adjusting the blue whitepoint of the picture.
 - R-BL**: allows you to customize the color temperature by adjusting the red blacklevel of the picture.
 - G-BL**: allows you to customize the color temperature by adjusting the green blacklevel of the picture.
- 3 Use the color buttons to reset to the predefined settings.
- 4 Press the red color button or the cursor left to return to the Picture menu.

Perfect Pixel HD

Perfect Pixel HD is the most ideal setting as it fully processes the image to make every single pixel the best it can be, improving contrast, sharpness, picture depth, color reproduction and brilliance from every source, including High Definition.

- Select **On** or **Off** to activate/de-activate Perfect Pixel HD.

120 Hz Clear LCD (if present)

120 Hz Clear LCD results in superior sharpness of motion reproduction, better black level, high contrast with a flickerfree quiet image and a larger viewing angle.

- Select **On** or **Off**.

Dynamic contrast

Automatically makes the contrast in the darker and the brighter picture areas more noticeable as the image on the screen changes.

- Normally select **Medium**. It may be preferred to select **Minimum**, **Maximum** or **Off**.

Noise reduction

Noise reduction automatically filters out and reduces the image noise. This improves picture quality when receiving weak signals.

- Select **Off**, **Minimum**, **Medium** or **Maximum** according to the image noise in the picture.

MPEG artifact reduction

MPEG artifact reduction **On** smoothens the transitions on digital content.

- Select **On** or **Off**.

Color enhancement

Automatically controls green enhancement and blue stretch. It makes the colors more vivid.

- Select **Off**, **Minimum**, **Medium** or **Maximum**.

Active control

The TV continuously measures and corrects all incoming signals in order to provide the best picture possible.

- Select **On** or **Off** to activate/de-activate Active control.

Light sensor

Light sensor **On** automatically adjusts the picture settings for best viewing dependent on the lighting conditions in the room.

- Select **On** or **Off**.

Picture format

See chapter 3.2 **Widescreen picture format** above.

5.2.3 Adjust sound menu settings

The sound menu contains the settings that affect the quality of the sound.

- 1 Press the **MENU** button on the remote control.
 - ▷ The main menu appears.
 - 2 Select **TV menu** and press the cursor right.
 - ▷ The TV Menu is moved to the left.
 - 3 Select **TV settings** and press the cursor right.
 - ▷ The TV settings menu is moved to the left panel.
 - 4 Select **Sound** and press the cursor right.
 - ▷ The Sound menu is moved to the left panel.
 - 5 Use the cursor up/down to select the Sound menu items.
 - 6 Press the cursor right to enter the selected Sound menu item.
- ❗ Dependent on the input signal, one or more menu items may not be selectable.
- 7 Use the cursor buttons to adjust the settings.
 - 8 Press the cursor left to return to the Sound menu.

TV menu	
TV settings	Sound
Settings assistant	Equalizer
Reset to standard	Volume
Picture	Balance
Sound	Audio language
	Alternate audio
	Mono/Stereo
	Sound mode
	Headphone volume
	Auto volume leveling
	Delta volume
	Auto surround
Info	

Equalizer

Allows you to select one of the predefined settings for the equalizer: **Standard**, **Speech**, **Multimedia** or **Music**.

TV menu/TV settings	
Sound	Equalizer
Equalizer	
Volume	
Balance	
Audio language	
Alternate audio	
Mono/Stereo	
.....	
Info	

Use the color buttons to select.

Use the cursor buttons to adjust the frequency response of the sound to match your personal taste.

⊕ This function is also accessible via the **OPTION** button on the remote control. See Chapter 3.1 **Use of the Option button**.

Volume

Allows you to adjust the sound output level.

Balance

Allows you to adjust the output of the right and left speakers to obtain the best stereo reproduction for your listening position.

Audio language

Allows you to select an audio language out of the list of the available broadcasted languages.

❗ If there is more than one variant for an audio language, then select one of the variants. To permanently change the audio language, use the Language menu in the Installation menu, see Chapter 7.2 **Select your language**.

⊕ This function is also accessible via the **OPTION** button on the remote control. See Chapter 3.1 **Use of the Option button**.

Alternate audio (only selectable with analog broadcast signals)

Gives you the possibility to swap between the **Main** and **Second audio Program** (SAP) when it is available.

Mono/Stereo

Allows you to select, per TV channel, Mono or Stereo sound when analog stereo broadcasts are available.

Sound mode

Allows you to select the modes for more spatial or surround sound reproduction dependent on the broadcasted signals or signals from external inputs received.

Headphone volume

Allows you to control the level of sound through the headphones.

Auto Volume Leveling

Automatically reduces the volume differences between channels and programs, providing a more constant overall level. This will also reduce the dynamics of sound.

Delta volume

Allows you to correct for any permanent volume differences between TV channels or external sources.

i You may change channels with the numeric buttons or the **CH-** or **+** button.

Auto surround

When turned **On**, this allows the TV to automatically turn to the best surround sound mode the broadcaster transmits.

6 Adjust Feature menu settings

The Features menu allows you to control the settings of special TV functions, features and accessory equipment.

- 1** Press the **MENU** button on the remote control.
 - ▷ The main menu appears.
- 2** Select **TV menu** and press the cursor right.
 - ▷ The TV Menu is moved to the left.
- 3** Select **Features** and press the cursor right.
 - ▷ The Features menu is moved to the left panel.

TV menu	Features
TV settings	Closed captions
Features	Caption service
Installation	Digital caption service
Software update	Digital caption options
	Sleeptimer

Info	

- 4** Use the cursor up/down to select the Features menu items.
- 5** Press the cursor right to enter the selected Features menu item.
- 6** Use the cursor buttons to adjust the settings.
- 7** Press the cursor left to return to the Features menu.

6.1 Closed captions

This displays the transmitted CC- or CS-text on the screen according to your chosen CC or CS service in the Caption or Digital caption service menu below. This text can either be permanently displayed (assuming that the service is available in the broadcast) or only when mute is active.

- 1** Press the cursor right after having selected **Closed captions**.
- 2** Select **On**, **Off** or **On during mute**.

6.2 Caption service

This allows you to select the Closed Captions service levels of analog broadcasting to be displayed. Closed Captioning allows you to read the voice content of television programs on the TV screen. Designed to help the hearing impaired, this feature uses on-screen 'text boxes' to show dialogue and conversations while the TV program is in progress. Captions will appear on the screen during captioned broadcasts.

- 1** Select **Caption service**.
- 2** Press the cursor right.
- 3** Select the desired Caption service:
 - ▷ **CC 1, 2, 3 or 4**
Dialogue (and descriptions) for the action on the captioned TV program shows on screen. Usually CC 1 is the most used. CC 2 may be used for alternate languages if they are being transmitted.
 - ▷ **T 1, 2, 3 or 4**
Often used for channel guide, schedules, bulletin board information for Closed Captions programs, news, weather informations or stock market reports.

Not all Caption services are necessarily being used by a TV channel during the transmission of a Closed Caption program.

6.3 Digital caption service

This allows you to configure the way you choose to view the digital captioning.

- Select one of the digital service channels made available by the caption provider.
There are 6 standard services.
 - **CS 1** is designated as the Primary Caption Service. This service contains the verbatim, or near-verbatim captions for the primary language being spoken in the accompanying program audio.
 - **CS 2** is designated as the Secondary Language Service. This service contains captions in a secondary language which are translations of the captions in the primary Caption Service.
 - The other service subchannels are not pre-assigned. It is up to the discretion of the individual caption provider to utilize the remaining service channels.
- ❗ - This television provides display of television closed captioning conforming with the EIA-608 standard and in accordance with Sections 15.119 of the FCC rules.
 - The captions do not always use correct spelling and grammar. Not all TV programs and product commercials are made for broadcast with Closed Caption informations included. Refer to your area's TV program listings for the TV channels and times of Closed Caption shows. The captioned programs are usually noted in the TV listings with service marks such as 'CC'.

6.4 Digital caption options

This allows you to modify how digital captions are displayed on your TV.

TV menu	
Features	Digital caption options
Closed captions	Reset to default
Caption service	Size
Digital caption service	Style
Digital caption options	Text color
Sleeptimer	Text opacity
Child lock	Background color
Set/Change PIN	Background opacity
On timer	Edge type
Demo	Edge color
Info	

- Select from the following options to change the visual characteristics of your TV's digital captioning.
 - **Reset to default**
Select this option to reset the digital caption options back to the captions provider default settings.
 - Press the cursor right and press the **OK** button to confirm.
 - **Size**
Select this option to select the size of caption display according to your own preference.
 - Select **Default** (Automatic), **Small**, **Standard** or **Large**.
 - **Style**
Select this option to select the font style of caption display according to your own preference.
 - Select **Default**, **Monospaced serif**, **Serif**, **Monospaced sans serif**, **Sans serif**, **Casual**, **Cursive** or **Small caps**.

- Text

Select this option to select the text color or the opacity of the text box of caption display according to your own preference.

- Select a color and one of the opacity options.

- Background

Select this option to select the character background color or one of the background opacity options of caption display according to your own preference.

- Select a color and one of the opacity options.

- Edge type

Allows you to select the edge type of caption display according to your own preference.

- Select a type.

- Edge color

Allows you to select the edge color of caption display according to your own preference.

- Select a color.

6.5 Sleeptimer

This sets a time period after which the TV automatically turns to standby.

- 1** Select **Sleeptimer**.
- 2** Press the cursor right.
- 3** Select a value with the cursor up/down. The list will have values from **0** to **180** minutes. You can always turn off your TV earlier or select another time set.

6.6 Child lock

With a 4-digit code, you are able to lock TV channels and external sources to prevent children from watching certain programs.

- 1** Select **Child lock**.

TV menu	
Features	Child lock
Closed captions	Lock after
Caption service	Channel lock
Digital caption service	TV ratings lock
Digital caption options	Movie ratings lock
Sleeptimer	
Child lock	
Set/Change PIN	
On timer	
Demo	
Info	

- 2** Press the cursor right to enter the Child lock menu.
- 3** Enter your 4-digit code.

❗ You have to re-enter your code each time you enter the Child lock menu.

- 4** Select one of the menu items of the Child lock menu and press the cursor right.

6.6.1 Lock after

1 Lock after is only selectable if time and date are known. See Chapter 7.6 - Set your Clock.

This allows you to prevent the viewing of the selected channel after a selectable time delay. Locked channels can still be tuned, but the picture is blanked and the audio is muted.

TV menu / Features	
Child lock	Lock after
Lock after	Timer
Channel lock	Time
TV ratings lock	
Movie ratings lock	
Region ratings lock	
Info	

- 1 Press the cursor right and select **Timer On** or **Off**.
 - ▷ When set to **On** this allows you to set the clock.
- 2 Select **Time** and press the cursor right.
 - ▷ This allows you to set the time after which the lock is set.
- 3 Select **AM** or **PM** to select the correct period of the day.
- 4 Enter the time with the digit or the cursor buttons.

6.6.2 Channel lock

This allows you to completely lock a certain TV channel or external source.

- o Select the channels or subchannels you want to lock.

6.6.3 TV ratings lock

Your TV is equipped with a V-chip. This allows you to control access to individual programs based on their movie and TV ratings. All settings apply to all AV inputs, except HDMI. The program content advisory data are sent by the broadcaster or program provider.

- 1 Select **TV ratings lock** with the cursor down.

TV menu / Features	
Child lock	TV ratings lock
Lock after	All
Channel lock	None
TV ratings lock	TV-Y
Movie ratings lock	TV-Y7
Region ratings lock	TV-G
	TV-PG
	TV-14
	TV-MA
Info	

- ▷ A list appears, showing the age-based TV ratings and a corresponding content-based ratings list.
- 2 Press the cursor right to enter the list.
 - 3 Select an age-based TV rating with the cursor up/down, and enter, if present, the list with content-based ratings with the cursor right, and select one content-based rating.
 - 4 Press **OK** to activate/de-activate the selected rating.
 - 5 Select another content-based rating if you like and press **OK** again.

Age-based rating	Content-based rating
All	None
None	None
TV-Y	None
TV-Y7	(FV) Fantasy Violence
TV-G	None
TV-PG	(D) Dialog (L) Language (S) Sex (V) Violence
TV-14	(D) Dialog (L) Language (S) Sex (V) Violence
TV-MA	(L) Language (S) Sex (V) Violence

When **All** has been selected, all items in the age-based and in the contents-based lists are locked.

If, while All is selected, any other item, either an age-based or content-based item, is unselected, then All is automatically unselected.

No rating is the selection for items that either have no rating information or have a rating of None. Both will be locked.

When an item on the age-based list is selected, all items below that item of the same group are locked as well.

When you select a content-based rating, all identical content-based ratings in the older age-based categories are also selected.

1 You can lock/unlock any number of ratings on the list without re-entering your code.

Each ratings item has a box-graphics in front of it to indicate whether or not programs carrying that rating are currently locked.

TV ratings

TV-Y appropriate for children of all ages with themes and elements suitable for children aged 2-6

TV-Y7 programs designed for children age 7 and older

TV-Y7-FV programs include fantasy violence more intense than other programs in the TV-Y7 category

TV-G programs suitable for all ages. These programs contain little or no violence, no strong language and little or no sexual dialogue or situations

TV-PG programs contain elements that some parents may find unsuitable for younger children and which may need parental guidance. The program may contain moderate violence, sexual dialogue and/or situations and some strong language.

TV-14 programs contain elements that may not be suitable for children under 14 years of age.

These programs include one or more of the following: intense violence, intense sexual situations, suggestive dialogue and strong language.

TV-MA programs are designed to be viewed by adults and may be unsuitable for children under the age of 17. These programs may contain graphic violence, explicit sexual activity and/or crude or indecent language.

6.6.4 Movie ratings lock

This function allows you to control access to individual movies based on their MPAA ratings (Motion Picture Association of America).

- 1 Select **Movie ratings lock** with the cursor down. A list appears, showing all valid MPAA content ratings.

TV menu / Features	
Child lock	Movie ratings lock
Lock after	All
Channel lock	NR
TV ratings lock	G
Movie ratings lock	PG
Region ratings lock	PG-13
	R
	NC-17
	X
Info	

- 2 Press the cursor right to enter the list.
- 3 Select a movie rating with the cursor up/down.
- 4 Press **OK** to activate/de-activate the selected rating.

Each rating item has a box-graphic in front of it to indicate whether or not programs carrying that rating are currently locked.

When **All** has been selected, all items on the movie ratings list become selected. (All movies are locked.)

If, while **All** is selected, any other item is unselected, then **All** is automatically unselected.

When any other item has been selected, all ratings below are selected as well, thus all movies with those ratings will be locked.

Movie ratings

NR not rated

G movies with a mild content, suitable for all ages

PG movies for which parental guidance is recommended. They may contain a few racy or violent scenes or maybe some bad language

PG-13 movies for which parental guidance may be recommended if under age 13

R restricted. The movies usually contain offensive sex or bad language and may be unsuitable for children under the age of 17. Parental guidance or permission needed.

NC-17 even with parental permission, forbidden under age 17. More offensive sex, violence or bad language.

X movies which generally focus on sex, violence and/or bad language. Also known as pornography.

6.6.5 Region ratings lock (if present)

This allows you to control access to individual programs based on their broadcasted regional rating.

- 1 Select **Region ratings lock** with the cursor down.
 - ▷ A list appears, showing all valid region ratings.

TV menu / Features	
Childlock	TV ratings lock
Lock after	
Channel lock	Please enter your PIN.
TV ratings lock	
Movie ratings lock	
Region ratings lock	
Info	

- 2 Press the cursor right to enter the list.
- 3 Select a region rating with the cursor up/down.
- 4 Press the **OK** button to activate the selected rating.
- 5 Select another region rating if you like and press **OK** again.
- 6 Press the cursor left to return to the **Child lock** menu.

6.7 Set / Change PIN

This allows you to set or change the personal 4-digit access code that is used in the different lock functions of the TV.

- 1 Select **Set or Change PIN** with the cursor down.

TV menu	
Features	Set/Change PIN
Closed captions	
Caption service	
Digital caption service	Please enter your current
Digital caption options	PIN.
Sleeptimer	□ □ □ □
Child lock	
Set/Change PIN	
On timer	
Demo	
Info	

- ▷ If no PIN-code exists yet, the menu item is set to **Set PIN**. Follow the instructions on screen.
 - ▷ If a PIN-code has previously been entered, the menu item is set to **Change PIN**. Follow the instructions on screen.
- 2 Enter your PIN with the digit buttons. All number combinations from 0000 to 9999 are valid numbers.
 - 3 The Menu preferences menu reappears with a message confirming that the PIN has been created.

! Important: you have forgotten your PIN !

- 1 Select **Change PIN** in the Features menu.
- 2 Press the cursor right to enter the overriding PIN code 0-7-1-1.
- 3 Enter a new personal 4-digit PIN code. The previous code is erased and the new PIN-code is stored.

6.8 On timer

From standby, this automatically turns the TV to the specified channel number, at a specified time.

- 1 Select **On timer**.
- 2 Press the cursor right to enter the On timer menu.
- 3 Select **Timer** and press the cursor right.
- 4 Select **On**.
- 5 Select **Channel** and then the TV channel you want your TV to turn to on a selected time and day
- 6 Select **Day** and then a day of the week or select **Daily**.
- 7 Select **Time** and enter the time with the digit buttons or with the cursor up/down.
- 8 Press the **OK** button to activate.
- 9 Press the cursor left to return to the Features menu or press the **MENU** button to turn off the menu.

! From now on, your TV will automatically turn to the selected channel, on the selected day, at the selected time, until the On timer function is turned off again.

! Only one On timer can be set.

6.9 Demo

This allows you to get an idea of the features that are part of the television.

- 1 Select **Demo**.

TV menu	
Features	Demo
.....	Perfect Pixel HD
Set/Change PIN	Settings Assistant
On timer	120 Hz Clear LCD
Demo	Active Control
Info	

- 2 Press the cursor right.
- 3 Select a desired demo.
- 4 Press the **OK** button to start the demo.
 - ▷ The selected demo is played once.
- 5 Press the red color button to stop the demo and to return to the demo menu.
- 6 Press the red color button to exit the demo menu.

7 How to search for and store TV channels

- ! You will need this chapter only if you want to change the installation settings.

7.1 Installation menu

This menu will adjust settings related to the installation of the TV channels.

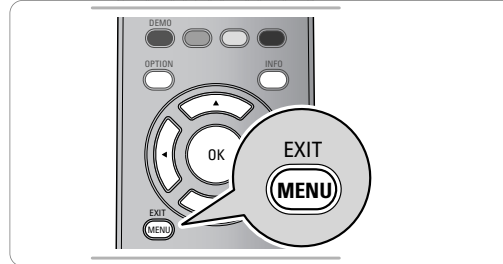

- 1 Press the **MENU** button on the remote control.
 - ▷ The main menu appears.

Television	TV menu
	Channel list
	Program guide
Multimedia	USBdevice 1

- 2 Select **TV menu** and press the cursor right.
 - ▷ The TV menu is moved to the left.
- 3 Select **Installation** and press the cursor right.
 - ▷ The Installation menu is moved to the left panel.

TV menu	Installation
TV settings	Language
Features	Channel installation
Installation	Preferences
Software update	Connections

Info	

- 4 Use the cursor up/down to select the Installation menu items.
- 5 Press the cursor right to enter the selected Installation menu item.
- 6 Use the cursor button to make a selection.
- 7 Press the **OK** button to activate or to confirm.
- 8 Press the cursor left to return to the Installation menu or press the **MENU** button to turn off the menu.

7.2 Select your language

This allows you to select your menu language out of the list of the available languages.

TV menu	
Installation	Language
Language	English
Channel installation	Français
Preferences	Español
Connections	Português
.....	
Info	

7.3 Store TV channels

After language is set correctly, you can now search for and store the TV channels.

- 1 Select **Channel installation** and press the cursor right.
- 2 Select **Autoprogram**.

TV menu / Installation	
Channel installation	Autoprogram
Autoprogram	
Installation update	Start now
Weak channel installat..	
Installation mode	
Channel edit	
Info	

- 3 Press the cursor right.
- 4 Press the **OK** button.
- 5 Select **Cable** or **Antenna** in the Installation mode.

TV menu/Installation	
Installation mode	
Antenna	Please select your installation mode.
Cable	
● Previous ● Next ● ●	

- ▷ When **Antenna** is selected, the TV will detect antenna signals and will search for antenna TV (NTSC and ATSC) channels available in your local area.
- ▷ When **Cable** is selected, the TV will detect cable company supplied signals and will search for cable TV (NTSC, ATSC, QAM modulated) channels available in your area.

! Make sure that registration with your cable TV provider and connection of equipment are completed.

- 6 Press the green corresponding color button on the remote control for **'Next'**.

! All channels must be unlocked in order to autoprogram. If requested, enter your PIN code to unlock all channels. See Chapter **6 Adjust features menu settings**.

- 7 Press the green corresponding color button on the remote control for **"Start"** to start autoprogramming.

- ▷ The menu screen disappears and the progress of autoprogramming is displayed. The progress bar indicates the number of analog and digital TV channels found.
- ▷ When Autoprogramming is complete, a message appears confirming the completion and the TV switches to the first installed TV channel.

- 8 Press the red color button to finish.

! Don't forget !

- When interrupted, the updated channel information is retained as well as the not yet updated old channel information.
- Background autoprogramming occurs only when the TV is turned on.
- Channel information of an ATSC channel is updated only for the ATSC channel currently tuned.
- Once you have searched for as well the available Antenna as well as the Cable TV channels, they are stored in the memory.

Channel tuning

! After the installation of the TV channels has been done, always make a selection in the Installation menu, Installation mode between Antenna or Cable whether you want to watch Antenna TV channels or Cable TV channels.

! If you make use of a signal splitter do not forget to put the switch in the corresponding position.

Available channels:

- Cable (analog NTSC or digital QAM): max. from 1 to 135
- Terrestrial (analog NTSC or digital ATSC): max. from 2 to 69

If a tuned channel is not yet in the master channel map, the TV will attempt to tune the channel and it will be added to the map.

If the channel is not acquired, a message will appear that the channel is not available.

When you tune an audio-only digital subchannel, a display appears with the message **Audio only**.

! Subchannel selections

The new standards employed with digital broadcasting make it possible to receive multiple program channels under a single major channel number which can be selected by pressing the digit channel number entry.

! Digital Channel selection delay

Due to the tuning complexity of subchannel digital programming, the time to select and view a digital channel may take slightly longer than what the viewer is normally accustomed to (as compared to analog channel programs).

Digital channel broadcasts contain program and system data information that must be processed before the channel selection can be displayed.

7.3.1 Installation update

This allows you to automatically tune to and update all available channels, without altering the sorting of existing channels.

TV menu / Installation	
Channel installation	Installation update
Autoprogram	
Installation update	Start now
Weak channel installat..	
Installation mode	
Channel edit	
Info	

- ! - New channels found will not be added to any favorite list.
- Already installed channels will not be renumbered.

7.3.2 Weak channel installation

This allows you to manually tune weak ATSC channels in order to adjust the antenna and thus optimize signal quality for that channel. This only available for TV channels installed via an antenna connection.

- 1 Select a channel in the displayed list of TV channels (in the antenna mode).
- 2 The signal strength is displayed and updated continuously as you rotate the antenna.

7.3.3 Installation mode

This allows you to select the already stored terrestrial or cable TV channels. Choose for Antenna or Cable whether these signals are present.

7.3.4 Channel edit

This allows you to rename, to reshuffle and to uninstall or reinstall the stored channels.

- Press the corresponding color button and follow the on screen instructions.

TV menu / Installation	
Channel installation	Channel edit
Autoprogram	0
Installation update	1
Weak channel installat..	2
Installation mode	3
Channel edit	4

Info	

7.3.4.1 Rename

This allows you to change the name stored in the memory or to assign a name to a channel for which a name has not yet been entered.

- 1 Select the channel you want to rename.
 - 2 Press the red color button on your remote control.
 - 3 Select the characters with the cursor up/down. Select the following position with the cursor right.
 - 4 Press the green color button or the **OK** button when finished.
- ⊕ - Press the yellow color button to delete all characters. The cursor is positioned at the beginning again;
 - Press the blue color button to delete the character the cursor is positioned. Enter a new character with the cursor up/down;
 - A name can be given to the channel numbers 0 to 999;
 - Space, numbers and other special characters are located between Z and A.
- 5 Select another channel number and repeat steps 2 to 5.

7.3.4.2 Uninstall - reinstall

This allows you to uninstall a stored channel so that it is no longer possible to tune to. This also allows you to reinstall an earlier uninstalled channel.

- 1 Select the channel you want to uninstall.
 - 2 Press the green color button to uninstall the selected channel.
 - ▷ The uninstalled channel is indicated in the list by an icon in front of the uninstalled channel.
 - 3 Press the green color button again to reinstall the uninstalled channel.
- ❗ Uninstalled channels are not reinstalled during an installation update.

7.4 Set your preferences

This menu contains items that can set or adjust various special TV functions and that will typically be accessed only occasionally.

TV menu	
Installation	Preferences
Language	Location
Channel installation	Volume bar
Preferences	Show emergency alerts
Connections	Downloaded rating table
Clock	
Reset AV settings	
Info	

7.4.1 Select your location

This allows you to select the location of your TV.

If you choose for **Retail shop** it will result in fixed settings of picture and sound.

The location **Home** will give full flexibility to change any predefined settings for picture and sound.

7.4.2 Select the volume bar

This allows you to select the display of the volume bar.

- 1 Select **Volume bar**.
- 2 Press the cursor right to select **On** or **Off**.
 - Select **On** to activate the temporarily display of the volume bar.

7.4.3 Show emergency alerts (EAS)

This allows you to select the alert priority level of the information disseminated by the cable operator. The standard SCTE18 defines an Emergency Alert signalling method for use by cable TV systems to signal emergencies to digital devices such as digital Cable boxes, digital TVs and digital VCRs.

The Emergency alert signalling scheme defined in the standard allows a cable operator to disseminate emergency alert information related to state and local-level emergencies and warnings in a cost-effective and efficient way, while minimizing disruption of programming.

An Emergency alert message will have one of the following priorities: Low, Medium, High or Maximum.

The Emergency alert message with priority High or Maximum will always be presented. Low or Medium will be present or ignored depending on the selected setting.

⚠ When the TV clock is undefined (See Chapter **7.6 Set your clock**), the Emergency Alert will be ignored.

The Emergency Alert message display will contain following information:

- The Emergency Alert text
- The start time + date
- The end time + date.

- 1 Select **Show emergency alerts** in the Preferences menu.
- 2 Press the cursor right and select one of the Emergency alerts options:
 - **Always**, when you always want the Emergency alert messages to be displayed when available;
 - **Skip low priority**, when you want the messages with low level to be ignored;
 - **Skip low/medium priority**, when you only want the messages with high priority to be displayed.

- ❗ - Emergency Alert Signalling is not possible:
 - with multimedia browser;
 - with analog video sources.
- You always have the possibility to remove the message from the screen.
- The message display will overlap whatever menu element or other message is on the screen.

7.4.4 Downloaded rating table

This allows you to add region ratings lock options next to your current ones.

TV menu / Installation	
Preferences	Downloaded rating table
Location	Off
Volume bar	On
Show emergency alerts	
Downloaded rating table	
Info	

- ❗ Before activating, please ensure regional ratings are broadcasted.

7.5 Select your connections

This allows you to identify the type of accessory device you have connected to each particular input and output.

- 1 Select **Connections**.

Menu TV	
Installation	Connections
Language	AV1
Channel installation	AV2
Preferences	AV3
Connections	HDMI 1
Clock	HDMI 2
Reset AV settings	HDMI 3
	Side
	AUDIO IN L/R
	DIGITAL AUDIO IN
Info	

- 2 Press the cursor right to enter the list of types of external inputs.
- 3 Select the appropriate input with the cursor up/down.
 - ▷ When you select **AV1, AV2, AV3, HDMI 1, HDMI 2, HDMI 3, Side, AUDIO IN L/R** or **DIGITAL AUDIO IN** a list appears allowing you to identify which type of accessory device is attached to this input.
- 4 Press the cursor right again to enter the list of types of devices connected to the selected input.
- 5 Select the accessory device with the cursor up/down.

Digital Audio In

If an accessory device has a digital audio output, you can connect this with a single cable to the TV's **DIGITAL AUDIO IN** jack.

In the Connections menu, assign the **DIGITAL AUDIO IN** to the corresponding external input to which your accessory device is connected.

In addition to accepting audio input via Digital Audio In, the TV can output encoded Dolby Digital audio via the **DIGITAL AUDIO OUT**

connector to an external amplifier or receiver.

If your amplifier or receiver has a matching connector for Digital Audio In, you can connect it with a single cable to the TV's digital audio out. See Chapter **11.1 To make Video and Audio connections**, Home theater amplifier.

7.6 Set your clock

This allows you to set the time and day.

- ❗ Adjusting the clock is necessary for the correct working of Lock after (See Chapter **6 Adjust feature menu settings**) features.

TV menu	
Installation	Clock
Language	Auto clock mode
Channel installation	Auto clock channel
Preferences	Time
Connections	Day
Clock	Time zone
Reset AV settings	Daylight saving
Info	

7.6.1 Auto clock mode

- 1 Select **Clock** in the Installation menu.
- 2 Press the cursor right to select the **Auto clock mode**.
- 3 Press the cursor right to instruct the TV to get the time automatically or manually.

- ❗ Most of the TV channels are not transmitting clock information. There are few cable channels but they are at the end of the channel ring. There is no clock transmission in antenna channels. In such cases either clock extraction is taking a long time or there is no clock.

7.6.2 Auto clock channel (only available when Auto clock mode is set to Automatic)

With the cursor buttons, select the channel number on which time can be found by the TV. Typically time can be found on PBS (Public Broadcasting System) as well as some other channels.

7.6.3 Time - Day (only available when Auto clock mode is set to Manual)

With the cursor buttons, select and enter the correct time and day. If **Auto clock mode Manual** has been selected, and no clock search has been done, the system will keep the entered time and day.

7.6.4 Time zone (only available when Auto clock mode is set to Automatic)

This function allows you to select your local time zone. Broadcasted time information will correct the clock display for your local time.

- 1 Select **Time zone** with the cursor down.
- 2 Press the cursor right to select your local time zone.

7.6.5 Daylight saving (only available when Auto clock mode is set to Automatic)

Daylight saving time is automatically set by specially broadcasted signals. This menu item allows you to disable the automatic setting of daylight saving time. This is useful if you live in an area or state where daylight saving is not applied, but you receive channels from other areas where daylight saving signals are broadcasted.

- 1 Select **Daylight saving** with the cursor down.
 - 2 Press the cursor right to select **Automatic** for automatic clock correction for daylight saving time, based on specially broadcasted signals.
 - 3 Select **Off** to disable automatic clock correction based on the specially broadcasted signals.
- ⓘ Changes in Clock settings are only activated after turning the set off and on again.

7.7 Reset AV settings

This allows you to reset most of the predefined factory states.

- 1 Select **Reset AV settings** with the cursor down.

TV menu	
Installation	Reset AV settings
Language	
Channel installation	Reset
Preferences	
Connections	
Clock	
Reset AV settings	
Info	

- 2 Press the cursor right.
- 3 Press the **OK** button to erase settings and reset them to their default values.

8 Create your favorite list

This allows you to select up to four favorite channels lists with your preferred TV channels. For example, each member of your family can create his/her own favorite list.

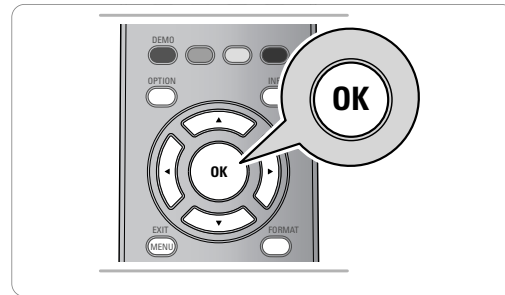

- 1 When the **OK** button is pressed the first time after you have finished the installation, it will bring up the full channel list. In other situations it will bring up the last selected channel list.

All channels	
AV1	
AV2	
HDMI	
1 Analog channel 1	
2 Digital channel 1	
3 Digital channel 2	
4	
• Select list	•
Info	

8.1 To select a channel from the displayed favorite list

- 1 Press the **OK** button.
 - ▷ The last selected channel list appears.
- 2 Use the cursor up/down to select a channel.
- 3 Press the **OK** button to display the selected channel.

8.2 To select another favorite channel list

- 1 Press the **OK** button.
 - ▷ The last selected channel list appears.

All channels	
AV1	
AV2	
All	
Favorites 1	
Favorites 2	
Favorites 3	
Favorites 4	
Select list	
Info	

- 2 Press the red color button to bring up the list of possible favorite channel lists.
- 3 Use the cursor up/down to select a list.
- 4 Press the **OK** button.
- 5 Press the **OK** button again to exit.

8.3 To create or modify a favorite list

- 1 Press the **OK** button.
 - ▷ The last selected channel list appears.
- 2 Press the red color button.
 - ▷ A list with all possible favorite channel lists appears.
- 3 Use the cursor up/down to select a Favorites (1 to 4) channel list.
- 4 Press the **OK** button.
- 5 Press the green color button to enter the Edit mode.
 - ▷ The selected Favorite list will bring up a full channel list.

Favorites 1	
Side	None
1
15
18
25
.....

Select list Edit list
 Info

- 6 Use the cursor up/down to select a channel.
 - 7 Press the **OK** button to check or uncheck the highlighted channel and to add it to or remove it from your selected favorite list.
 - 8 Press the green color button again to leave the Edit mode.
 - ▷ The modified favorite channel list appears.
 - Press the **OK** button again to exit.
 - ▷ With the **-CH+** button you will be able to browse through the TV channels of the selected list.
 - 9 Press the red color button to remove the channel list.
- ! With the numeric buttons you can still select channels which are not marked as favorite.

9 Electronic Program Guide

(only with Digital TV broadcasting)

The Electronic Program Guide shows you detailed information about the current program and also about the next program (if this information is available).

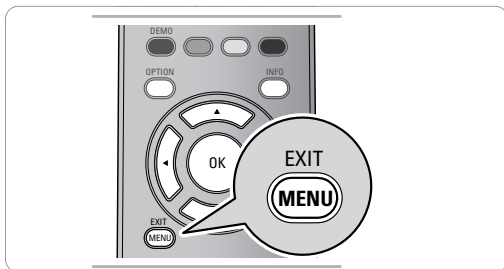

- 1 Press the **MENU** button.

Television	TV menu
	Channel list
	Program guide
Multimedia	USBdevice 1

- 2 Select **Program guide** and press the cursor right.
 - ▷ The EPG screen appears. Dependent on conditions it may take some time to acquire EPG data.
 - ▷ The EPG screen updates automatically if the EPG data is acquired successfully. If not, the EPG screen remains blank.
 - ▷ Information about the selected program appears.
- 3 Use the colored buttons to activate the available EPG features displayed at the bottom of the screen.
- 4 To quit the Program Guide page, press the **MENU** button again.

10 Multimedia browser

The Multimedia browser lets you display pictures or play audio files stored on a USB device. The Multimedia browser application is invoked from the main menu.

- 1 Press the **MENU** button on the remote control.

Television	TV menu
	Channel list
	Program guide
Multimedia	USBdevice 1

- 2 Select **Multimedia** and press the cursor right.
- 3 Select the USB device inserted into the USB connector at the side of the TV.
- 4 Press the cursor right and select a content type.

- Following file formats can be reproduced:
 - for pictures: JPEG
 - for audio: MP3, LPCM
- Only FAT/DOS-formatted memory devices are supported.
- Philips can not be held responsible if your USB device is not supported.

10.1 To view content from a USB device

- ! If your USB device does not fit into the USB connector at the side, use an USB extend cable (max. 2 m) to connect the USB device to the USB port. Ask your dealer for more information.

10.1.1 To insert a USB device

- ! USB devices are not supplied with this TV.

Insert a USB device to the USB connector at the side of the TV. When a USB device is inserted, the Multimedia browser menu is displayed automatically. See further.

10.1.2 To remove the USB device

- 1 Press the **MENU** button on the remote control to turn off the main menu.
- 2 Remove the USB device.

10.2 Multimedia Browser menu

- 1 Insert a USB device.
- 2 Select the USB device under Multimedia with the cursor up/down.

USB	Picture
Picture	Afrika_2001
Music	Paris_2006
	My_car.jpg
	Jean.jpg
	Mary.jpg

- ▶ The Multimedia browser allows you to browse content stored on the inserted USB device.
- ▶ The 2-panel browser will be shown with the left panel containing the content types (Pictures, Music).
- ▶ The right panel will display the content that is available of the selected content type.

Picture	Afrika_2001
Afrika_2001	Kenya.jpg
Paris_2005	Congo.jpg
My_car.jpg	Victoria.jpg
Jean.jpg	Dakar.jpg
Mary.jpg	Cairo.jpg

- 3 Press the cursor right to enter the content.
- 4 Press the cursor up/down to select a content.

Afrika_2001	Afrika_2001
Kenya.jpg	 Kenya.jpg
Congo.jpg	
Victoria.jpg	
Dakar.jpg	
Cairo.jpg	

- 5 Press the cursor right to enter the content.
- 6 Press the cursor up/down to select a file or a directory.

USB Afrika_2001 Kenya.jpg
 Kenya.jpg

➤ Press the green color button to display all the image files in the current directory as thumbnails when browsing pictures. Press the green button again to display the image files in a list.

- 7 In case a **file, directory, album** or **playlist** is selected, press the cursor right to enter the content or press the **OK** button to start a slide show or a loop playback of the files present.
- 8 Press the cursor left to keep music playing and switch back to the Multimedia menu.
- 9 Press one of the color buttons on the remote control to perform the corresponding function mentioned at the bottom of the screen.

➤ The blue color button can, if necessary, be used to let the color buttons reappear.

❗ The playback will continue to play even if temporarily switched to browser screens. The audio will be stopped when another song starts playing, or when the end has been reached.

Following icons may appear:



Function buttons at the bottom of the screen

Details

to display a description of the selected file or directory

Transitions

to select if you like to apply a transition during a slide show

Slide time

to select the duration a picture will be displayed in a slide show

Rotate

to rotate a picture

Repeat one/all

to repeat the playback of a music file

Shuffle

to shuffle music collections in a random way

Zoom

to select one of the zoom magnifications (x1, x2, x4) with the cursor up/down.

Additionally you can shift the selected zoom window over the screen with the cursor buttons

❗ To rotate a picture or to select one of the zoom magnifications, first stop the slide show with the **OK** button or the blue color button.

11 How to connect and operate accessory devices

- 1 Connect your accessory AV device. See following pages.
- 2 Link your devices to the connections in the Installation menu. See Chapter 7.5 **Select your connections**.

TV menu	
Installation	Connections
Language	AV1
Channel installation	AV2
Preferences	AV3
Connections	HDMI 1
Clock	HDMI 2
Reset AV settings	HDMI 3
	Side
	AUDIO IN L/R
	DIGITAL AUDIO IN
Info	

- 1 In case of Digital audio connection also link the **DIGITAL AUDIO IN** to the corresponding input.
In case of Analog audio connection (via Component Video Output (YPbPr) on **AV3** or via **HDMI**), also link the **AUDIO IN L/R** to the corresponding input.
- 3 To operate the desired connected device:
 - Turn on your connected device.
 - Press the **SOURCE** button on the remote control.

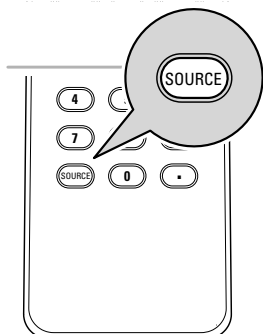

- Select your source with the cursor up/down.
- Press the **OK** button.

11.1 Side panel overview

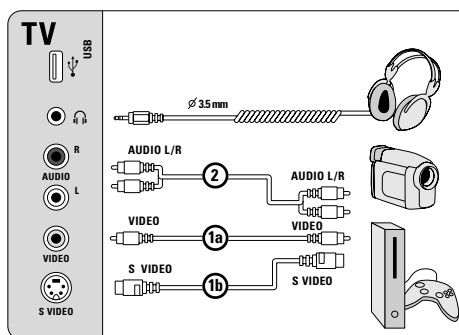

11.2.1 Camera, Camcorder, Game, PC

Do not connect cable 1a and 1b at the same time. This may cause picture distortion !

⚠ Caution

Before connecting a PC, set the PC monitor refresh rate to 60Hz.

11.2.2 Headphone

Select **Headphone volume** in the Sound menu to adjust the headphone volume. See Chapter 5.2.3 **Adjust sound menu settings**.

⚠ Press **MUTE** on the remote control to turn off the internal loudspeakers of the TV.

11.2.3 USB

See Chapter 10 **Multimedia browser**.

11.2 To make video and audio connections

❗ Use the inputs that are available on your device that provide the best video or audio performance, as below.

BEST



BEST PERFORMANCE	CONNECTOR CABLE	AUDIO CONNECTION REQUIRED
 HDMI	HDMI (High-definition Multimedia Interface)	No
 HDMI	DVI to HDMI (High-definition Multimedia Interface)	 DIGITAL AUDIO IN
 HDMI	DVI to HDMI (High-definition Multimedia Interface)	 ANALOG AUDIO IN
	Component video (480p, 720p, 480i, 1080i) - for digital audio (AV1, AV3)	 DIGITAL AUDIO IN
	- for analog audio (AV1, AV3)	 AV 3 AV 1
 S VIDEO	S VIDEO (AV1, Side)	 AV1 Side
 VIDEO	VIDEO	 AV1 Side
 75 Ω	RF/Coaxial	No

- ⊕ - If you experience a discolored line on the left or right side of the set, adjust the picture position to the center of the screen with the cursor buttons.
- Cables are often color-coded to connectors. Connect red to red, white to white....
- Component video (YPbPr) connection is necessary to view video sources, for example digital broadcastings coming from a settop box, in 1080i, 1080p, 720p, 480i or 480p;
- The labels for the component video sockets may differ depending on the DVD player or the device connected. Although the abbreviations may vary, the letters B and R stand for the blue and red component signals, respectively, and Y indicates the luminance signal. Refer to the DVD player's or devices instructions for use for definitions and connection details;
- This television is designed to accept high definition signal standards 480p, 720p, 1080p and 1080i as specified by the Electronic Industries Association standard EIA770.3. Digital devices from different manufacturers have the possibility of differing output standards which may cause difficulties for the television to properly display.

⊕ DVI to HDMI

- Your TV comes with all types of connectors with the exception of the DVI connector but some of your equipment may be equipped with this type. In this case you'll need a DVI to HDMI adapter or a HDMI to DVI cable and separate audio cables, all available at your local dealer.
- Be sure to connect the DVI output connector first, then connect to the HDMI input on your TV.

11.3 Connect a recorder (VCR / DVD-R)

⚠ Do not place your recorder too close to the screen as some recorders may be susceptible for signals.

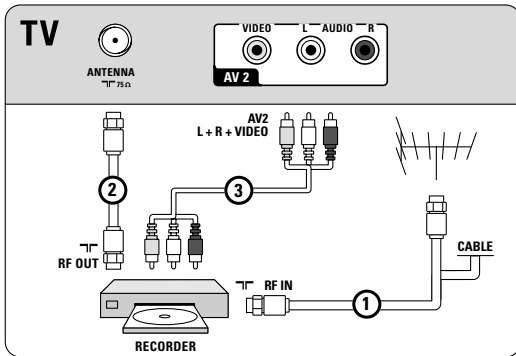

11.4 Connect a recorder (VCR / DVD-R) and a second A/V device

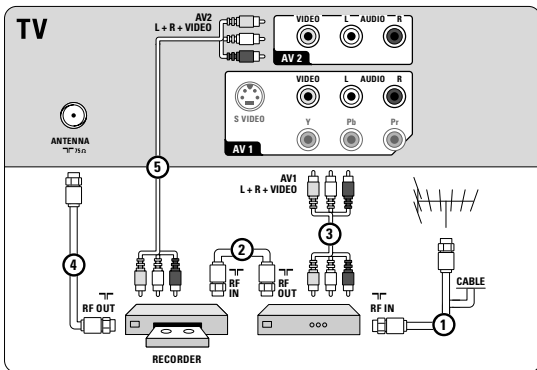

If your recorder has an S-VHS video jack: for improved picture quality, connect a S-Video cable with the **S-VIDEO** input and connect the audio cables to the **AUDIO L** and **R** input jacks of **AV1**.

⚠ When using the **S-VIDEO** connector do not connect any device to the **AV1** video jack.

In case of mono equipment, only the left loudspeaker reproduces sound. Use a mono to stereo adapter (not supplied) for sound reproduction via all internal loudspeakers.

11.5 Connect a DVD player/DVD recorder, Set top box, game console,... with a HDMI (High Definition Multimedia Interface) connector

⊕ HDMI is the leading new standard for Digital Video and audio interconnection.

Sound and picture interruptions ? See Chapter 12 Problems.

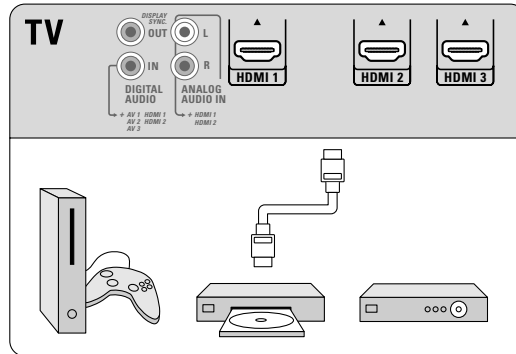

11.6 Connect a DVD player/DVD recorder, Set top box, game console,... with a DVI connector

11.6.1 With DIGITAL AUDIO OUT

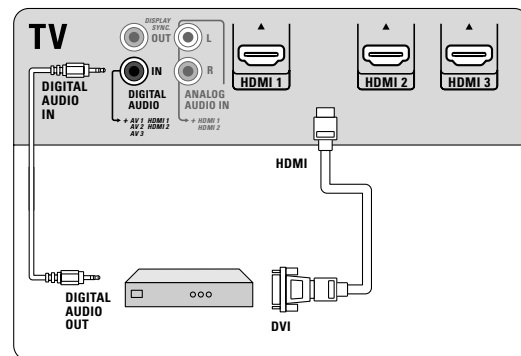

11.6.2 With ANALOG AUDIO OUT

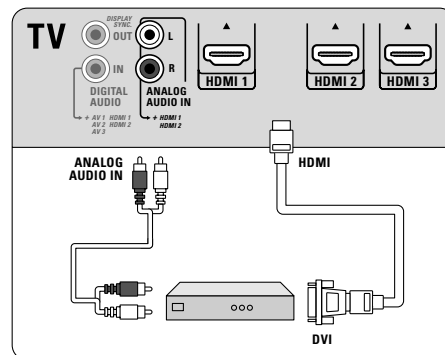

11.7 Connect a DVD player with a S-VIDEO connector

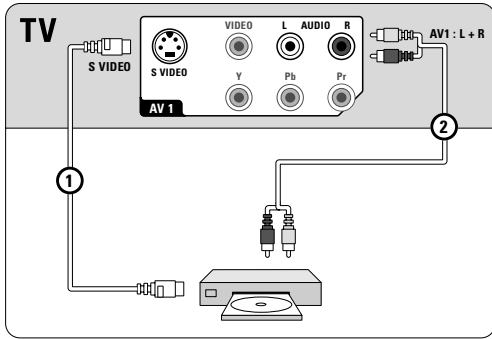

ⓘ When using the **S-VIDEO** connector, **do not** connect any device to the **AV VIDEO** input that you are using.

11.8 Connect a recorder and Set top box with RF output

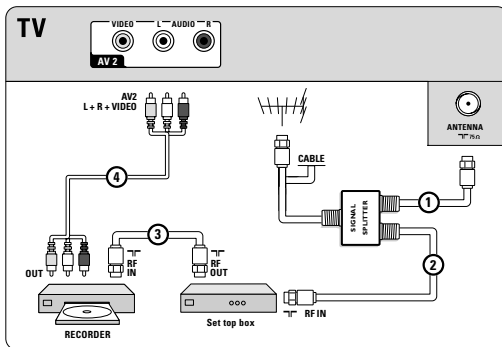

11.9 Connect a satellite receiver or Set top box with A/V outputs

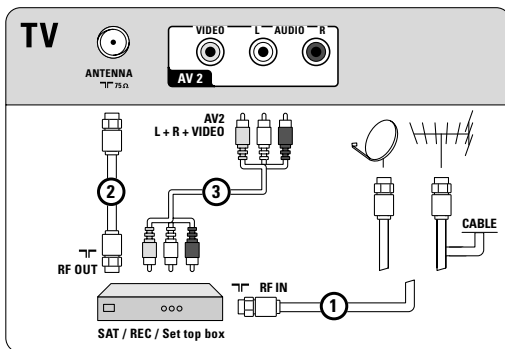

If your device has an S-VHS video jack: For improved picture quality, connect a S-video cable with the **S-VIDEO** input of **AV1** and connect the audio cables to the **AUDIO L** and **R** input jacks of **AV1**.

ⓘ When using the **S-VIDEO** connector do not connect any device to the **AV1** video jack.

In case of mono equipment, only the left loudspeaker reproduces sound. Use a mono to stereo adapter (not supplied) for sound reproduction via all internal loudspeakers.

11.10 Connect a satellite receiver or Set top box and a recorder with A/V outputs

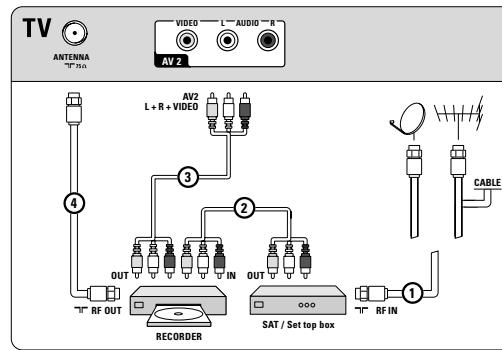

If your device has an S-VHS video jack: For improved picture quality, connect a S-video cable with the **S-VIDEO** input of **AV1** and connect the audio cables to the **AUDIO L** and **R** input jacks of **AV1**.

ⓘ When using the **S-VIDEO** connector do not connect any device to the **AV1** video jack.

In case of mono equipment, only the left loudspeaker reproduces sound. Use a mono to stereo adapter (not supplied) for sound reproduction via all internal loudspeakers.

11.11 Connect digital source devices with Component Video Output connectors (YPbPr)

This TV is capable of displaying 1080i, 1080p, 720p and 480p DTV signals when connected to a DTV tuner cable box. Select the output of the cable box to either 1080i, 1080p, 720p or 480p. A DTV signal must be available in your area.

11.11.1 With DIGITAL AUDIO

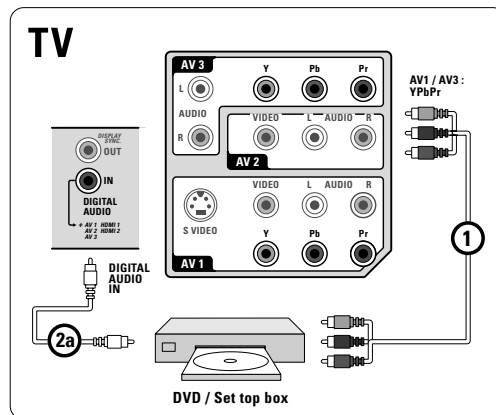

11.11.2 With ANALOG AUDIO

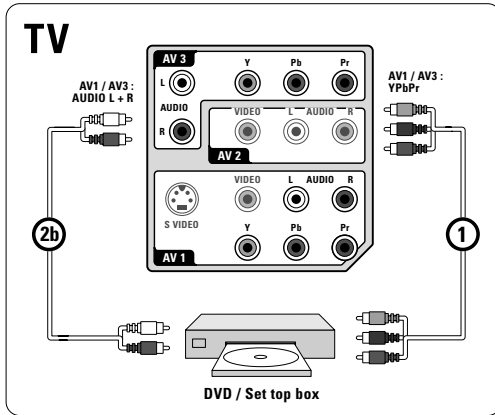

11.12 Connect a Home Theater Amplifier

11.12.1 Digital Home Theater Amplifier

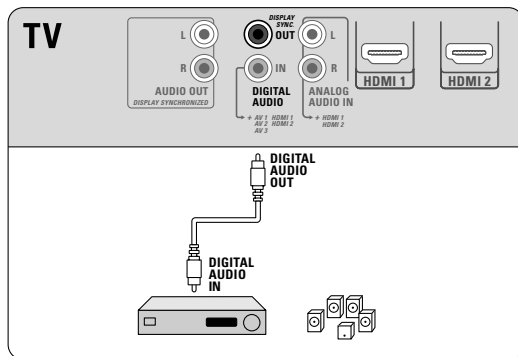

11.12.2 Analog Home Theater Amplifier

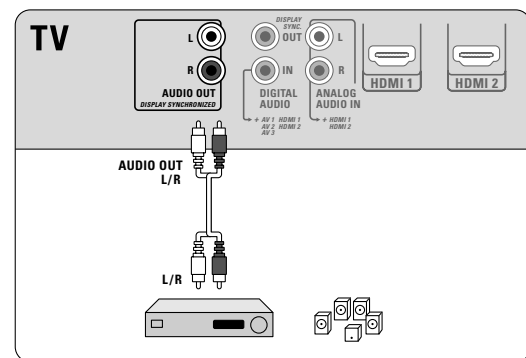

⚠ Due to legal requirements, it is possible that with certain copy protected PCM audio qualities from a accessory device connected to the **HDMI** input, the Digital audio signal is muted.

11.13 Connect a PC

11.13.1 Equipped with a S-VIDEO connector at the side

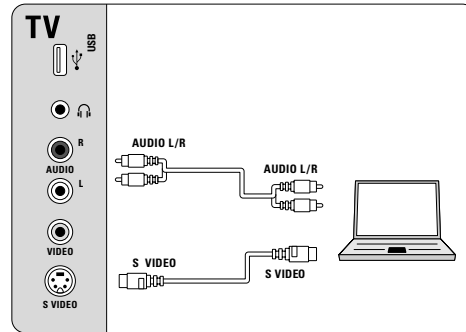

11.13.2 Equipped with a S-VIDEO connector at the back

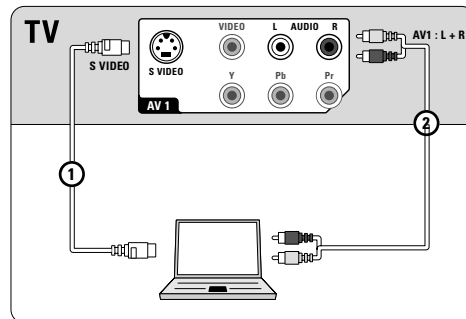

11.13.3 Equipped with a DVI connector

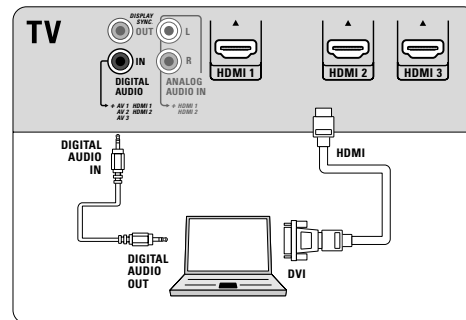

11.13.4 Equipped with a HDMI connector

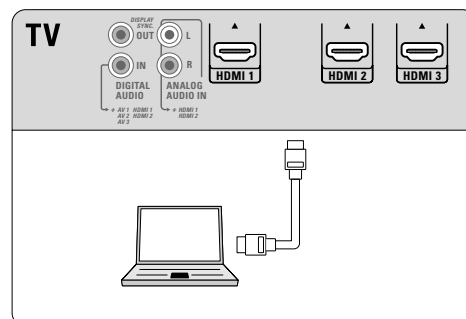

⊕ If necessary you can adjust the picture position to the center of the screen with the cursor buttons.

12 Problems

“Ghost” or double images

- This may be caused by obstruction to the antenna due to high rise buildings or hills. Using a highly directional antenna may improve the picture.

No power

- Verify that the TV's AC power cord is plugged into the mains socket.
- Unplug the television, wait for 60 seconds. Then re-insert plug into the mains socket and turn on the television again.

No picture

- Verify antenna connections at the bottom of the TV to see if they are properly connected to the TV.
- Possible broadcast station trouble. Try another channel.
- Adjust the contrast and brightness settings.
- Verify the Closed Captions control. Some TEXT modes could block the screen.
- Verify if you selected the correct AV source.

No picture and power turned on

- Your TV has a protective mode in case there is too much heat build-up. Verify the clearance around the vents of the device to be certain there are no blocking walls or cabinets which would limit the air flow.

Picture position adjustment

When displaying a High Definition signal from the YPbPr inputs or HDMI input, if necessary, you can adjust the picture position to the center of the screen with the cursor left/right or up/down buttons on the remote control. This may be needed due to slight differences in output signals from different brands and types of HD sources boxes.

❗ Most High Definition receiver boxes also have picture-positioning controls in their menu systems. If the TV cursor controls run out of range before the picture is correctly positioned, the receiver box controls will need to be adjusted.

No photo, music or video play or in poor quality only

- Verify if the source complies with a supported code.

No sound

- Increase the VOLUME.
- Verify that the TV is not muted, press the **MUTE** button on the remote control.
- When no signal is detected, the TV automatically turns off the sound. This is proper operation and does not indicate a malfunction.

Sound and picture interruptions using HDMI to HDMI connection

- If it occurs occasionally, perhaps there is something wrong with the broadcasted program.
- If it occurs persistently, see the manual of your connected device to verify the necessary adjustments.
- Alternatively, connect an extra audio cable (either an analog or a digital audio cable) from your connected device to your TV. Verify whether you selected the connected device in the Installation menu, Select your connections and also select the respective audio input in the same Connections menu.
- Limit the HDMI cable length to max 5 m.
- Verify if the connected device is properly selected in the Installation menu, Connections, according to the connection you have made **HDMI 1 or 2**.

No sound when using DVI to HDMI connection

- Verify whether you properly connected the audio cable to the **DIGITAL AUDIO IN** or **ANALOG AUDIO IN L/R** connector of the TV.
- Verify whether you selected the connected device in the Installation menu, Select your connections and if you linked it to **HDMI 1, 2 or 3**, according to where you made the connection. Also verify if you selected **DIGITAL AUDIO IN** or **AUDIO IN L/R** in the same Connections menu.

Good sound but poor color or no picture

- Adjust the contrast, color, tint and brightness setting.
- Select Reset AV settings in the Installation menu.

Snowish picture and noise

- Verify the antenna connection.

Television not responding to remote control

- Verify whether the batteries are working. Replace if necessary.
- Clean the remote control sensor lens on the monitor.
- Operating range between TV and the remote control should not be > 240”.
- You can still use the buttons at the side of your TV.

The software will not install

Possibly the operating system is wrong.

Go to www.philips.com/welcome to see which operating systems are supported.

No stable or not synchronized VGA picture

- Check if you have selected the correct VGA mode in your PC.

Control of accessory devices

- The infrared signals of the screen may influence the reception sensibility of other peripherals
Solution: replace the batteries of the remote control of other devices.
E.g. keep away a wireless headphone from within a radius of 50”.

Standby

Your TV consumes energy in standby mode. Energy consumption contributes to air and water pollution.

After improper shutdown

If your TV has been shutdown in an improper way (e.g. power drop, power cord plug out), starting up the TV again will take a longer time than usual.

❗ If your problem is not solved

Turn your TV off and then on again once.

Never attempt to repair a defective TV yourself.

Check with your dealer or call a TV technician.

Telephone number Philips Customer Care Center: 1-888-PHILIPS (744-5477)

Please, have the Model and Product number which you can find at the back and the bottom of your television set ready, before calling.

13 Glossary

- 1080i/p** A 1080 screen uses the highest available resolution to display both 1080i and 1080p signals in the highest possible image quality without loss of resolution
- 720p** Displays images using progressive scanning with 720 horizontal lines.
- ATSC** Digital antenna signals with HDTV programming.
- NTSC** Analog signals, on cable or antenna, in Standard definition.
- QAM** Digital scrambled and unscrambled cable signals with HDTV programming.
- YPbPr** Component video inputs.
- CS** Digital Caption Service
- CC** Analog Caption Service
- DTV** A new technology for transmitting and receiving broadcast television signals. DTV provides higher resolution and improved sound quality over analog television.
- DV** Digital Video (from a camera)
- EAS** Emergency Alert System
Method for use by cable TV systems to signal emergencies to digital terminal devices such as digital STV, digital TV receivers and digital VCRs. It allows a cable operator to disseminate emergency alert information related to state and local-level emergencies and warnings.
- HDMI** (High Definition Multimedia Interface)
Provides an uncompressed, all digital audio/video interface between the TV and any HDMI-equipped audio/video component, such as a set top box, DVD player and AV receiver. HDMI supports enhanced or high-definition video plus two-channel digital audio.
- DVI** (Digital Visual Interface)
A digital interface standard created by the Digital Display Working Group (DDWG) to convert analog signals into digital signals to accommodate both analog and digital monitors.
- S-VHS signals** There are 2 separate Y/C video signals from the S-VHS and Hi-8 recording standards. The luminance signals Y (black and white) and chrominance signals C (color) are recorded separately on the tape. This provides better picture quality than with standard video (VHS and 8 mm) where the Y/C signals are combined to provide only one video signal.

14 Recycling

 The packaging of this product is intended to be recycled. Apply to the local authorities for correct disposal.

14.1 Disposal of your old product

Your product is designed and manufactured with highly quality material and components, which can be recycled and reused. Like all LCD products, this set contains a lamp with mercury. Please inform yourself about the local separate collection system for electrical and electronic products. Please act according to your local rules and do not dispose of your old products with your normal household waste. The correct disposal of your old product will help prevent potential negative consequences for the environment and human health.

14.2 Disposal of batteries

The batteries supplied do not contain the heavy metals mercury and cadmium. Please check on how to dispose of exhausted batteries according to local regulations.

15 Product information

- Your TV consumes energy in standby mode. Energy consumption contributes to air and water pollution. Very low standby power consumption.
- Specifications: see the product leaflet on www.philips.com/welcome.

15.1 Philips on-line support

The website for support: www.philips.com/welcome offers you all information you need to optimally enjoy your TV, and to make your home entertainment experience even more enjoyable. Please visit www.philips.com/welcome and enter your modelnumber to view:

- FAQ (Frequently Asked Questions)
- Latest updated user manuals
- Firmware upgrade files for your TV
- Product information
- ...

15.2 Open source software

This television contains open source software. NV Philips Innovative Applications hereby offers to deliver or make available, upon request, for a charge no more than the cost of physically performing source distribution, a complete machine-readable copy of the corresponding source code on a medium customarily used for software interchange.

To obtain the source code, write to
NV Philips Innovative Applications,
Assistant to the Development Manager
Pathoekeweg 11,
B-8000 Brugge - Belgium (Europe)

This offer is valid for a period of 3 years after the date of purchase of this product.

Annex 1 - Philips TV Slideshow Format with background music

- ❗ Philips can't be held responsible for any problems that may occur as a result of the content in this document. Errors reported to Philips will be adapted and published as soon as possible.

Introduction

This document explains how to make a Philips slideshow file with background audio.

Be aware that the content of this document is addressing technical or software skilled users.

To start the slideshow open the slideshow file in the Multimedia browser of your TV.

- 1 Press the **MENU** button on the remote control after having inserted a USB device and turned on the TV.

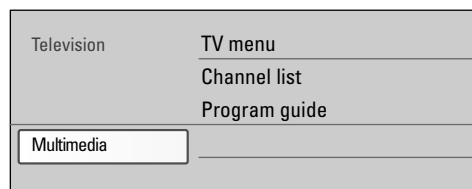

- 2 Select **Multimedia** and press the cursor right.
- 3 Go to where you stored the slideshow file (.alb) on your portable memory.
- 4 Select the slideshow file and press the **OK** button to start the slide show.

General Rules

- The slideshow will use plain ASCII XML syntax to allow the creation and editing of the slideshow files using simple tools.
- All references to network content must be based on the global address of the content.
- Content on a Portable Memory (PM) doesn't have a global address; as a result content from a PM can never be referenced from a slideshow not stored on the PM itself.
- To maintain portability, a slideshow stored on a PM should **ONLY** reference content on the same PM. Referencing global addresses can result in inconsistencies if the PM is used on a non-networked CE device. The latter is however not forbidden, it is only a recommendation.

Supported XML-tags

The following table gives a description of the XML syntax.

Tag Name	Use	Description
philips-slideshow	mandatory	Philips slideshow signature including the version.
title	optional	The title of the playlist.
audio	optional	The audio-URL following this tag will define the music playing in the background during the slideshow. A single song or playlist (.m3u & .pls) are the only valid audio references. Other reference will not result in any audio playback. If a single song is referenced the song will be repeated forever. If a playlist is referenced the playlist will be played in sequence with a repeat at the end of the playlist.
slide-duration	optional	The default display time (in 0,1 second) of a slide. The TV application isn't obliged to support this tag. The TV application can force the use of one or multiple predefined display times.
slides	mandatory	Identifies the slides to show.
slide	optional	Identifies the URL of the individual slide.

- It is preferable that URL's referencing PM content are based on a relative path starting from the directory where the slideshow is stored. This path includes the device or drive name of the PM.
 - An absolute path to content will also be supported.
- relative path:
pictures\test1.jpg, tamper.jpg, ..\new\bird.jpg, ...
- absolute path:
USB1:\pictures1\foo_bar.jpg, C:\f1.jpg, \organization.jpg, ...

General Format

The format and syntax below will be used to create the slideshow file (simple ascii text) with the extension .alb (.ALB). Examples: slshow1.alb, summer_holiday_2004.ALB, test.alb, ...

The following syntax should be used to create the text file:

```
<?xml version="1.0" encoding="ISO-885h9-1" ?>
<philips-slideshow version="1.0" >
  <title>Title of the slideshow</title>
  <audio>audio_url</audio>
  <slide-duration>30</slide-duration>
  <slides>
    <slide>slide_1_url</slide>
    <slide>slide_2_url</slide>
    <slide>slide_3_url</slide>
    <slide>slide_4_url</slide>
    <slide>slide_5_url</slide>
    <slide>slide_6_url</slide>
    ...
    <slide>slide_N-1_url</slide>
    <slide>slide_N_url</slide>
  </slides>
</philips-slideshow>
```

Annex 2 - Philips TV - Digital camera and USB issues

- ❗ - The software of your TV is updatable. If you have problems first check if you have the latest software installed on your TV. The latest software, together with instructions, can be found on the Philips support website. Use the type number of your TV to find this documentation and other related files.
- Philips can't be held responsible neither for any errors in the content of this document nor for any problems as a result of the content in this document. Errors reported to Philips will be adapted and published as soon as possible.

Digital Camera Issues

If a USB connection between your digital camera and the TV isn't working, you can try the solutions below to resolve your problem.

- Make sure your digital camera is turned on and verify if the configuration of your digital camera is correct (see the manual of your digital camera for more information).
- Some digital cameras allow you to turn off the USB interface. Make sure that the USB interface is turned on before connecting to the TV.
- If you have a digital camera with only internal memory (no removable memory) you can try to copy the content manually to a USB memory device using a personal computer.
- Some digital cameras allow you to switch between PTP (Picture Transfer Protocol) or "PC Link" and USB Mass Storage. Make sure that you select USB Mass Storage or "PC Drive" on your digital camera.
- If your camera supports different interface settings be sure to try them one by one or contact the reseller of your camera to find out the correct setting.

USB Memory Device Issues

- Devices connected to the USB port of your TV must be "Mass Storage Class" compliant. If your device (digital camera, MP3 player, ...) is not "Mass Storage Class" compliant it will not be detected by the content browser of the TV.
- The following subsets of the Mass Storage Class specification are supported:
The implementation of the TV is based on the "Universal Serial Bus Mass Storage Class Specification Overview" (v1.2, June 23, 2003) including all documents referenced by the document. The document can be found on the USB standardization website (www.usb.org).
Full support of the USB Mass Storage Class Bulk-Only Transport (bInterfaceProtocol = 50h).
Full support of SubClass Code = 05h; SFF-8070i spec.
Full support of SubClass Code = 06h; SCSI transparent command set.
- For large USB memory devices, when you are in the Content Browser, it may take a long time before you can access your files.

Annex 3 - Issues referring to connected accessory devices with a HDMI or Component Video output connector

The **HDMI IN** and Component Video connectors allow the following TV and monitor modes:

HD	Standard Definition TV (SDTV)	640x480i	60 Hz
		720x480i	60 Hz
		720x576i	50 Hz
Enhanced Definition TV (EDTV)		640x480p	60 Hz
		720x480p	60 Hz
		720x576p	50 Hz
High Definition TV (HDTV)		1920x1080i	50/60 Hz
		1920x1080p	24/25/30/35/60 Hz
		1280x720p	50/60 Hz

The **HDMI IN** connectors allow the following PC modes:

PC	640x480	60 Hz
	800x600	60 Hz
	1024x768	60 Hz
	1280x768	60 Hz
	1360x768	60 Hz
	1920x1080	60 Hz

- If necessary, you can adjust the picture position to the center of the screen with the cursor buttons.
- Due to legal requirements, it is possible that with certain copy protected PCM audio qualities from a an accessory device connected to the **HDMI** input, the Digital audio output signal is muted.
- Proper working is only guaranteed with HDMI compliant consumer products. Limit the cable length to maximum 5 m.
- In case no signal is detected from your HDMI devices, turn off the HDMI device and then on again.

Annex 4 - Software update

How to update the TV software

Use of the Update assistant

Philips continuously tries to improve its products and it wants you to profit of that even after your purchase. Therefore it allows you to update your TV software using a USB memory device (not supplied).

Note

The device must have at least 48Mb free space. Make sure the write protection is turned off.

Step 1 USB Memory device to TV

- 1 Select **TV menu** and press the cursor right.
 - ▷ The TV menu appears.
- 2 Select **Software update** and press the cursor right.
 - ▷ The Software update menu appears.

TV menu	
Software update	Update assistant
Update assistant	Start now
Current software info	
Local updates	
Info	

- 3 Select **Update assistant** and press the cursor right.
- 4 Press the **OK** button to activate.
- 5 Insert a USB memory device to the USB connector at the side of the TV.
 - ▷ The main menu appears.
- 6 Press the green color button to proceed.
 - ▷ A message appears the TV has successfully written an identification file to the USB memory device.
- 7 Press the green color button again to finish.
- 8 Remove the USB memory device from the TV.

Step 2 USB Memory device to PC

- 1 Insert the USB memory device into a PC linked to the internet.
- 2 Locate and open the file "update.htm" on your device.
- 3 Follow the instructions on the page displayed.
 - ▷ The software update is downloaded on the USB memory device (on condition the software version is newer than the one currently installed).
- 4 Remove the USB memory device from your PC.

Step 3 USB Memory device back to TV

- ⚠ - do not remove the USB portable memory device during the software update procedure;
- in case of a power drop during the update procedure, don't remove the USB portable memory from the TV. The TV will continue the update as soon as the power comes back.

- 1 Insert the USB memory device in the **USB** slot of the TV.

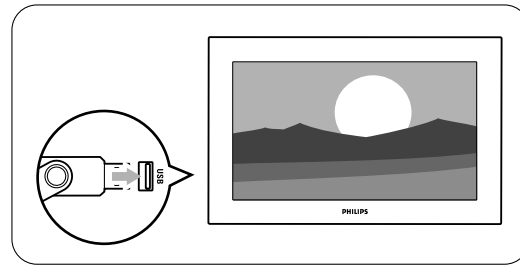

- 2 The TV turns off. The screen stays black for about 10 seconds. Please, wait and do not use the **POWER** switch on the TV.

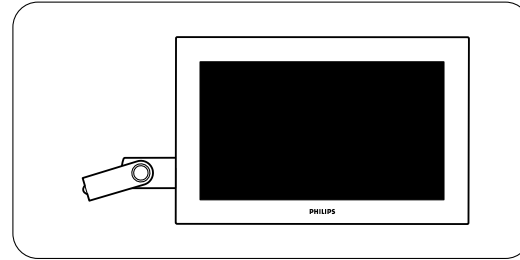

- 3 The update process starts automatically. Please wait.

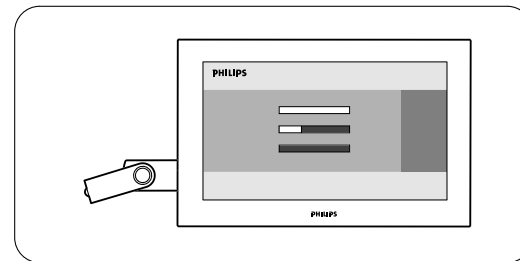

- 4 The update is finished when the message 'Operation successful' appears on the screen.

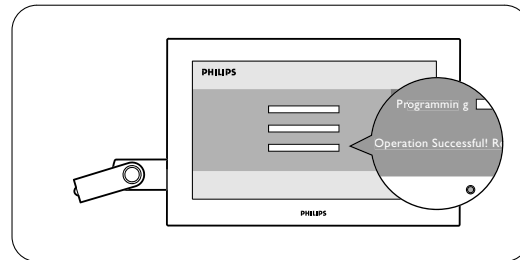

- 5 Remove the USB memory device from the TV.

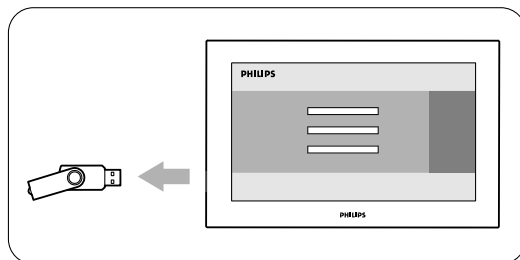

- 6 Press the **POWER** button on the remote control. Do not press more than once.

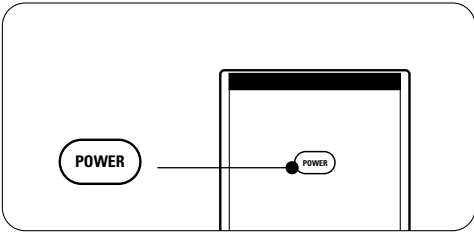

- 7 Do not use the **POWER** switch on the TV.
- 7 The TV turns off. The screen stays black for about 10 seconds. Please, wait.

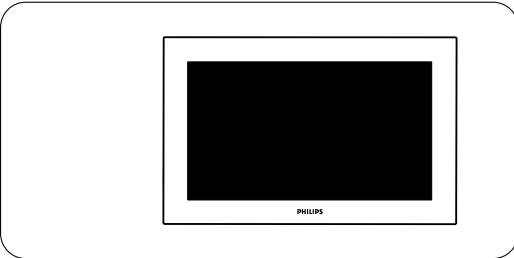

- 8 The TV turns back on again. The update is done.

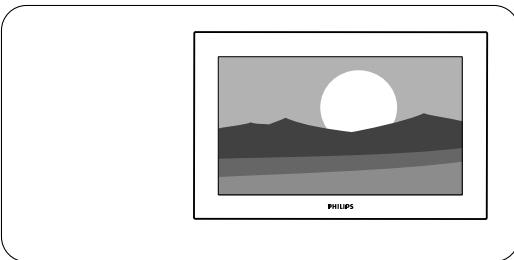

- 9 Once the upgrade is finished, use your PC to remove the TV software from your USB portable memory.

Verifying the version of the TV software

Updating software is only possible if the version of the new available software is different from the current one. You can verify your current software version.

- 1 Select **Software update** in the TV menu.
- 2 Press the cursor right.
 - The Software update menu moves to the left panel.

TV menu	
Software update	Current software info
Update assistant	Version:
Current software info	JX31.....
Local updates	Release

Info	

- 3 Select **Current software info** to observe the version and the description of the current software.

Local updates

For Service use only.

Index

A

Autoprogram 17
Auto surround 12
Alternate audio 11
Antenna 5
Auto volume levelling 12

B

Balance 11
Batteries 5,29
Button
 cursor 6
 MENU 6
 MUTE 6
 OK 6
 POWER 6
Brightness 10

C

Cable 5
Care of the screen 2
Clock 19
Closed captions 12
 service 13
 options 13
Camera 23
Channels
 uninstall 18
 edit 18
 installation 17
 store 17
Code
 Set 15
 Change 15
Color 10
 buttons 6
 temperature 10
Connections 19
 side 23
 audio/video 24
Connector
 HDMI 25
Contrast 10

D

Daylight saving 19
Delta volume 12
Demo 16
DVD
 recorder 25
 player 25

E

Emergency alert signalling 18

F

Features menu 12

G

Game 23,25
Getting started 4
Glossary 29

H

Headphone 23
 volume 12
Home theater amplifier 27

I

Installation 16
 Weak channel 17
 First time 8

K

Kensington lock 3

L

Language 16
 audio 11
Lock 13
 after 14
 channels 14
 TV ratings 14
 movie ratings 15
 region ratings 15

M

Multimedia browser 21

N

Navigate through the menus 9
Noise reduction 11

O

On timer 16
Overview
 side panel 23

P

PC 27
Picture
 menu 10
Problems 28

R

Recorder 25
Remote control 6
Recycling 29
Reset AV settings 20

S

Safety warnings 2
Satellite receiver 26
Set top box 25
Sharpness 10
Sleeptimer 13
Software update 33
Sound
 menu 11
 mode 12

T

Time zone selection 19
Tint 10
Turn the TV on 7
TV menu settings 9

U

USB
 connector 23
 device 21

V

VCR 25
Video comp. connectors 26
Volume 6,11

W

Widescreen picture format 7

Need help ?

Online help

www.philips.com/welcome

www.philips.com/support (outside USA)



USA

1 888 PHILIPS (744 5477)

Mo-Sat 7am-11pm,

Sun 8am-11pm 7 days a week, except public holidays.

Canada

01 800 363 7278 English

01 800 661 6162 Français

Please, have the Model and Serial Number ready before your call.
You can find these numbers on the packaging label or on the back and bottom of your TV.

Model:

Serial No: _____

Regulatory Notices - Federal Communications Commission Notice

This equipment has been tested and found to comply with the limits for a Class B digital device, pursuant to part 15 of the FCC Rules. These limits are designed to provide reasonable protection against harmful interference in a residential installation. This equipment generates, uses, and can radiate radio frequency energy and, if not installed and used in accordance with the instructions, may cause harmful interference to radio communications. However, there is no guarantee that interference will not occur in a particular installation. If this equipment does cause harmful interference to radio or television reception, which can be determined by turning the equipment off and on, the user is encouraged to try to correct the interference by one or more of the following measures:

Reorient or relocate the receiving antenna.

Increase the separation between the equipment and the receiver.

Connect the equipment into an outlet on a circuit different from that to which the receiver is connected.

Consult the dealer or an experienced radio or television technician for help.

Modifications -

The FCC requires the user to be notified that any changes or modifications made to this device that are not expressly approved by Philips Consumer Electronics may void the user's authority to operate the equipment.

Cables -

Connections to this device must be made with shielded cables with metallic RFI/EMI connector hoods to maintain compliance with FCC Rules and Regulations.

Canadian notice -

This Class B digital apparatus meets all requirements of the Canadian Interference-Causing Equipment Regulations.

Avis Canadien -

Cet appareil numérique de la classe B respecte toutes les exigences du Règlement sur le matériel brouilleur du Canada.

PHILIPS LIMITED WARRANTY

ONE (1) YEAR

WARRANTY COVERAGE:

PHILIPS warranty obligation is limited to the terms set forth below.

WHO IS COVERED:

Philips warrants the product to the original purchaser or the person receiving the product as a gift against defects in materials and workmanship as based on the date of original purchase ("Warranty period") from an Authorized Dealer. The original sales receipt showing the product name and the purchase date from an authorized retailer is considered such proof.

WHAT IS COVERED:

The Philips warranty covers new products if a defect arises and a valid claim is received by Philips within the Warranty Period.

At its option, Philips will either (1) repair the product at no charge, sing new or refurbished replacement parts, or (2) exchange the product with a product that is new or which has been manufactured from new, or serviceable used parts and is at least functionally equivalent or most comparable to the original product in Philips current inventory, or (3) refund the original purchase price of the product.

Philips warrants replacement products or parts provided under this warranty against defects in materials and workmanship from the date of the replacement or repair for ninety (90) days or for the remaining portion of the original product's warranty, whichever provides longer coverage for you. When a product or part is exchanged, any replacement item becomes your property and the replaced item becomes Philips' property.

When a refund is given, your product becomes Philips' property.

Note: Any product sold and identified as refurbished or renewed carries a ninety (90) day limited warranty.

Replacement product can only be sent if all warranty requirements are met. Failure to follow all requirements can result in delay.

WHAT IS NOT COVERED - EXCLUSIONS AND LIMITATIONS

This Limited Warranty applies only to the new products manufactured by or for Philips that can be identified by the trademark, trade name, or logo affixed to it. This Limited Warranty does not apply to any non-Philips hardware product or any software, even if packaged or sold with the product. Non-Philips manufacturers, suppliers, or publishers may provide a separate warranty for their own products packaged with the bundled product.

Philips is not liable for any damage to or loss of any programs, data, or other information stored on any media contained within the product, or any non-Philips product or part not covered by this warranty. Recovery or reinstallation of programs, data or other information is not covered under this Limited Warranty.

This warranty does not apply (a) to damage caused by accident, abuse, misuse, misapplication, or non-Philips product, (b) to damage caused by service performed by anyone other than Philips or Philips Authorized Service Location, (c) to a product or a part that has been modified without the written permission of Philips, or (d) if any Philips serial number has been removed or defaced, or (e) product, accessories or consumables sold "AS IS" without warranty of any kind by including refurbished Philips product sold "AS IS" by some retailers.

This Limited Warranty does not cover:

- Shipping charges to return defective product to Philips.
- Labor charges for installation or setup of the product, adjustment of customer controls on the product, and installation or repair of antenna systems outside of the product.
- Product repair and/or part replacement because of improper installation, connections to improper voltage supply, abuse, neglect, misuse, accident, unauthorized repair or other cause not within the control of Philips.
- Damage or claims for products not being available for use, or for lost data or lost software.
- Damage occurring to product during shipping.
- A product that requires modification or adaptation to enable it to operate in any country other than the country for which it was designed, manufactured, approved and/or authorized, or repair of products damaged by these modifications.
- A product used for commercial or institutional purposes (including but not limited to rental purposes).
- Product lost in shipment and no signature verification receipt can be provided.
- Failure to operate per Owner's Manual.

TO OBTAIN ASSISTANCE IN THE U.S.A., PUERTO RICO, OR U.S. VIRGIN ISLANDS....

Contact Philips Customer Care Center at:
1-888-PHILIPS (1-888-744-5477)

TO OBTAIN ASSISTANCE IN CANADA....

1-800-661-6162 (French speaking)
1-888-PHILIPS (1-888-744-5477) (English or Spanish speaking)

REPAIR OR REPLACEMENT AS PROVIDED UNDER THIS WARRANTY IS THE EXCLUSIVE REMEDY FOR THE CONSUMER. PHILIPS SHALL NOT BE LIABLE FOR ANY INCIDENTAL OR CONSEQUENTIAL DAMAGES FOR BREACH OF ANY EXPRESS OR IMPLIED WARRANTY ON THIS PRODUCT. EXCEPT TO THE EXTENT PROHIBITED BY APPLICABLE LAW, ANY IMPLIED WARRANTY OF MERCHANTABILITY OR FITNESS FOR A PARTICULAR PURPOSE ON THIS PRODUCT IS LIMITED IN DURATION TO THE DURATION OF THIS WARRANTY.

Some states do not allow the exclusions or limitation of incidental or consequential damages, or allow limitations on how long an implied warranty lasts, so the above limitations or exclusions may not apply to you.

This warranty gives you specific legal rights. You may have other rights which vary from state/province to state/province.

Philips, P.O. Box 671539, Marietta, GA. 30006-0026

