

Register your product and get support at:

[www.philips.com/TVsupport](http://www.philips.com/TVsupport)

32PHT5505

43PFT5505

---

EN User Manual

**PHILIPS**



# Table of contents

---

<b>1</b>	<b>Caution</b>	<b>2</b>
----------	----------------	----------

---

<b>2</b>	<b>Important</b>	<b>3</b>
	Safety	3

---

<b>3</b>	<b>Overview of your TV</b>	<b>5</b>
	Remote control	5
	Using the remote control	6

---

<b>4</b>	<b>Using the TV</b>	<b>7</b>
	Switching the TV on or off	7
	Switch channels	7
	Adjust the TV volume	8

---

<b>5</b>	<b>Other uses of the TV</b>	<b>9</b>
	Accessing the TV menu	9
	Changing the picture and sound settings	9
	Function settings	10
	Using the timer	11
	Playing multimedia files from USB devices	12
	Updating the TV software	13
	Restoring factory settings	13

---

<b>6</b>	<b>Setting up channels</b>	<b>14</b>
	Setting up channels automatically	14
	Swapping channels	14
	Renaming channels	14
	EPG	14
	Recording option	15
	Time-shift option	15

---

<b>7</b>	<b>Connecting the TV</b>	<b>17</b>
	Down ports	17
	Side ports	17
	Connecting to a computer	18
	Using Philips EasyLink	19

---

<b>8</b>	<b>Product information</b>	<b>20</b>
	Display resolutions	20
	Multimedia	20
	Audio output power	20
	Intrinsic resolution	20
	Tuner/reception/transmission	20
	Remote control	20
	Power supply	20
	Supported TV mounts	21

---

<b>9</b>	<b>Troubleshooting</b>	<b>22</b>
----------	------------------------	-----------

---

<b>10</b>	<b>Warranty</b>	<b>25</b>
-----------	-----------------	-----------

# 1 Caution

2019©TP Vision Europe B.V. All rights reserved. Specifications are subject to change without notice. All trademarks are the property of Koninklijke Philips N.V. or their respective owners. TP Vision Europe B.V. reserves the right to change products at any time without being obliged to adjust previously supplied products. The material in this manual is adequate for the intended use of the system. If the product, or its individual modules or procedures, are used for purposes other than those specified herein, their validity and suitability must first be confirmed. TP Vision Europe B.V. warrants that the material itself does not infringe upon any patents from the United States. No further warranty is expressed or implied. TP Vision Europe B.V. accepts no responsibility for any errors in the content of this document, nor for any issues that arise due to the content of this document. Errors reported to Philips will be rectified and published on the Philips support website as quickly as possible.

## Terms of warranty

- Risk of injury, damage to the TV or voided warranty! Never attempt to repair the TV yourself.
- Please only use the TV and accessories as set out by the manufacturer.
- The caution sign printed on the back of the TV indicates the risk of electric shock. Never remove the TV cover. Please contact Philips Customer Support if repairs are needed.
- Operations expressly prohibited in this manual, or any adjustments and assembly steps that are not recommended or authorised in this manual, are not within the scope of the warranty.

## Pixel characteristics

This LCD/LED product has a high number of colour pixels. Although its proportion of effective pixels is 99.999% or more, black dots or bright points of light (red, green or blue) may appear persistently on the screen. This is a structural property of the display (within common industry standards), and is not a fault.

## Mains fuse (/56)

This TV is fitted with an approved moulded plug. Should the mains fuse need replacing, it must be replaced with a fuse of the same value as indicated on the plug (e.g. 10A).

- 1 Remove the fuse cover and fuse.
- 2 The replacement fuse must comply with BS 1362 and carry the ASTA approval mark. If the fuse is lost, please contact your dealer to confirm the correct type.
- 3 Refit the fuse cover.

## Copyright



®Kensington and Micro Saver are registered US trademarks of ACCO World Corporation with issued registrations and pending applications in other countries and regions throughout the world.



HDMI, the HDMI logo and High-Definition Multimedia Interface are trademarks or registered trademarks of HDMI Licensing LLC in the United States and other countries and regions. All other registered and unregistered trademarks are the property of their respective owners.



This product is manufactured under license from Dolby Laboratories. Dolby, Dolby Audio and the double-D symbol are registered trademarks of Dolby Laboratories.

## 2 Important

Please read and make sure you understand all instructions before using the TV. Damage caused by a failure to follow the instructions is not covered by the warranty.

### Safety

#### Risk of electric shock or fire!

- Never expose the TV to rain or water; Never place liquid containers (such as vases) next to the TV. If liquids are spilt on or inside the TV, disconnect the TV from the power supply immediately. Contact the Philips Customer Service Centre to have the TV checked before you use it again.
- Never place the TV, remote control or batteries near naked flames or other heat sources (including direct sunlight). To avoid fire spreading, always keep candles or other naked flames away from the TV, remote control and batteries.



- Never insert any objects into the ventilation slots or other openings on the TV.
- Make sure that no strain is placed on the power cable when swivelling the TV. Strain on the power cable can loosen connections and cause arcing.
- The power plug of the TV must be disconnected to disconnect the TV from the mains supply. When you disconnect the power, always pull out the power plug, and never the cable. Ensure that the power plug, power cable and outlet socket are accessible at all times.
- The power plug is a disconnection device and should be kept so that it is easy to operate.

#### Risk of short circuit or fire!

- Never expose the remote control or batteries to rain, water or excessive heat.
- Avoid pulling the power plug. Loose power plugs can lead to arcing or fire.

#### Risk of personal injury or damage to the TV!

- TVs weighing more than 25 kg must be carried by at least two people.
- Use the stand supplied when mounting the TV on a stand. Secure the TV to the stand tightly. Place the TV on a flat, level surface that can bear the weight of the TV and the stand.
- When mounting the TV on a wall, use a wall mount that can bear the weight of the TV. Secure the wall mount bracket to a wall that can bear the total weight of the TV and the wall mount. TP Vision Europe B.V. accepts no responsibility for improper wall mounting leading to accident, injury or damage.
- Remove the stand from the TV when storing the TV. Never place the TV face down with the stand attached.
- Before connecting the TV to the power outlet, make sure that the power voltage matches the value printed on the back of the TV. Never connect the TV to the power outlet if the voltages do not match.
- This product contains glass parts. Handle with care to avoid injury or damage.

#### Risk of injury to children!

Follow these precautions to prevent the TV from toppling over and injuring children:

- Never place the TV on a surface covered by a cloth or other material that can be pulled away.
- Make sure that no part of the TV hangs over the edge of the supporting surface.
- When you place the TV on high furniture (such as a bookcase), both the furniture and the TV must be secured either to the wall or a suitable support.
- Educate children on the dangers of climbing on furniture to reach the TV.

#### Risk of swallowing batteries!

- The product/remote control may contain coin-type batteries, which can easily be swallowed. Keep these batteries out of reach of small children at all times!

#### Risk of overheating!

- Never install the TV in a confined space. Leave a space of at least 4 inches (10 cm) around the TV for ventilation. Ensure that the ventilation slots on the TV are not covered by curtains or other objects.

### Risk of injury, fire or power cord damage!

- Never place the TV or any objects on the power cable.
- Disconnect the TV from the power outlet and antenna before lightning storms. During lightning storms, never touch any part of the TV, power cable or antenna.

### Risk of damage to hearing!

- Avoid the use of earphones or headphones at high volume for prolonged periods.

### Low temperatures

- If the TV is transported in temperatures below 5°C (41°F), unpack the TV and wait for it to reach room temperature before connecting the TV to the power outlet.

---

## Screen care

- Avoid static images as much as possible. Static images are images that remain onscreen for extended periods. Examples include onscreen menus, black bars and time displays. If you must use static images, reduce the screen contrast and brightness to avoid screen damage.
- Unplug the TV before cleaning.
- Use a soft damp cloth to wipe the TV and frame. Never use substances such as alcohol, chemical products or household cleaners to clean the TV.
- Risk of damage to the screen! Never touch, push, rub or strike the screen with an object.
- Wipe off any water as quickly as possible to avoid deformation and discolouration.



Note

Static images may cause permanent damage to the TV screen.

- Do not display static images on LCD TV screens for longer than 2 hours, as this can cause ghosting onscreen. To prevent ghosting, reduce the brightness and contrast of the screen when displaying static images.
- Watching programmes in 4:3 format for extended periods may leave different marks on the left and right of the screen and the border of the image. Therefore, avoid using this mode for prolonged periods.

- Displaying static images from video games and computers for extended periods may cause an afterimage and ghosting due to screen burn. Reduce the screen brightness and contrast accordingly when using the TV in this way.

Any afterimages, ghosting or marks displayed on the TV screen due to the causes mentioned above are not covered by the warranty.

---

## Recycling



This product has been manufactured using high-performance materials and components that can be recycled and reused.



When the crossed-out wheeled bin symbol is attached to a product, the product is covered by European Directive 2002/96/EC. Familiarise yourself with your local separate collection system for electrical and electronic products. Follow local regulations and do not dispose of your old products with normal household waste. Proper disposal of old products helps to prevent potential harm to the environment and human health.



This product contains batteries covered by European Directive 2006/66/EC. These batteries cannot be disposed of together with normal household waste.

Educate yourself on local regulations covering the separate collection of batteries, as proper battery disposal helps to prevent harm to the environment and human health.

# 3 Overview of your TV

Congratulations on your purchase and welcome to Philips! To fully benefit from the support offered by Philips, please register your TV at [www.philips.com/TVsupport](http://www.philips.com/TVsupport).

## Control panel

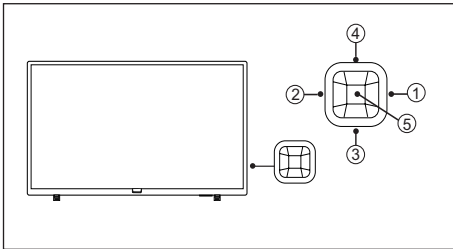

- ① **Volume+**: Without the key menu, the volume-up function is available.
- ② **Volume-**: Without the key menu, the volume-down function is available.
- ③ **Channel-**: When there is no keyboard menu, switch to the prior channel function; when the keyboard menu appears, move up and down the appropriate options.
- ④ **Channel+**: When there is no keyboard menu, switch to the next channel function; when the keyboard menu appears, move up and down the appropriate options.
- ⑤ **Signal source/OK**: In standby, the signal source/OK key is used as a power key. Press this key to boot. After booting, the signal source/OK key is used to open the keyboard menu functions. Note: In USB mode, the signal source/OK key has no function.

## Remote control

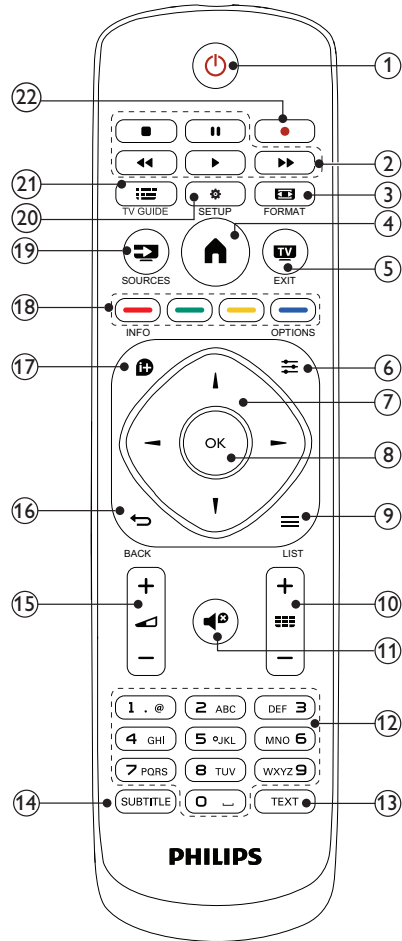

- ① **⏻ (Standby/On)**  
Switch the TV on or to standby.
- ② **Playback buttons**  
Control video, music or text.
- ③ **FORMAT**  
Change picture format.
- ④ **Home**  
Access or exit from the main menu and return to the previous menu.

- ⑤ **TV EXIT**  
Switches to TV.
- ⑥ **≡ OPTIONS**  
In TV mode, access Options to select audio.
- ⑦ **▲ ▼ ◀ ▶ (Navigation buttons)**  
Navigate through menus and select items.
- ⑧ **OK**  
Confirm an entry or selection.
- ⑨ **≡ LIST**  
Access or exit from the TV channel list.
- ⑩ **CH +/- (Channel +/-)**  
Changes channels; scrolls up/down through the options in USB mode.
- ⑪ **🔇 (Mute)**  
Mute or restore audio.
- ⑫ **0-9 (Numeric buttons 0-9)**  
Select channel.
- ⑬ **TEXT**  
Enable or disable teletext.
- ⑭ **SUBTITLE**  
Select the subtitles.
- ⑮ **+/- (Volume)**  
Adjust volume.
- ⑯ **↶ BACK**  
Return to the previous menu or exit from a certain function, and switch to the previous channel or signal source.
- ⑰ **ℹ INFO**  
Display information about current activity.
- ⑱ **Color buttons**  
Select tasks or options.
- ⑲ **📺 SOURCES**  
Select connected devices
- ⑳ **⚙ SETUP**  
Accesses TV setup menu.
- ㉑ **📺 TV GUIDE**  
Accesses or exits the TV guide.
- ㉒ **● Red dot**  
Recording function.

---

## Using the remote control

When you use the remote control, hold it close to the TV and point it at the remote control sensor. Make sure that the line-of-sight between the remote control and TV is not blocked by furniture, walls or other objects.

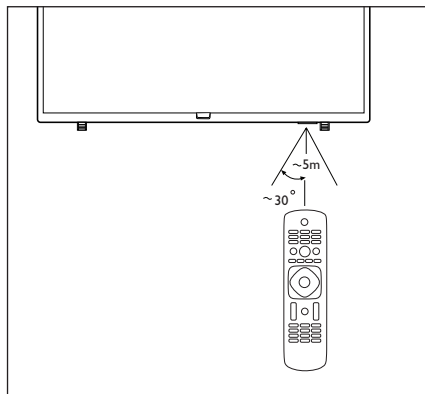



# 4 Using the TV

This section helps you to perform basic TV operations.

## Switching the TV on or off

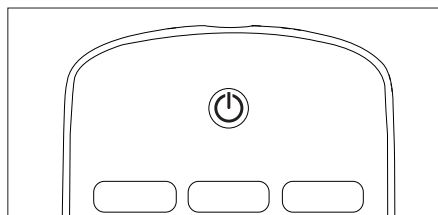
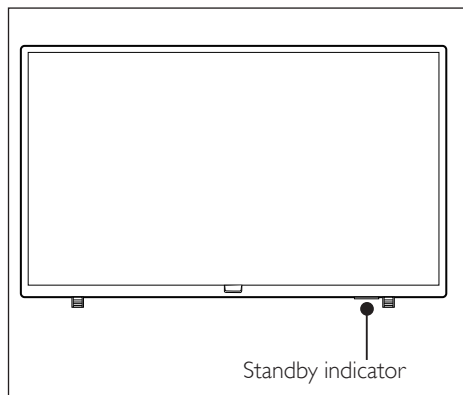

### To switch on

- Plug in the power plug.
  - ↳ If the standby indicator is red, press **⏻** (Standby-On) on the remote control.

### To switch to standby

- Press **⏻** (Standby-On) on the remote control.
  - ↳ The standby indicator switches to red.



### Tip

- Though your TV consumes very little power when in standby mode, energy continues to be consumed. When not in use for an extended period of time, disconnect the TV power cable from the power outlet.

## Switch channels

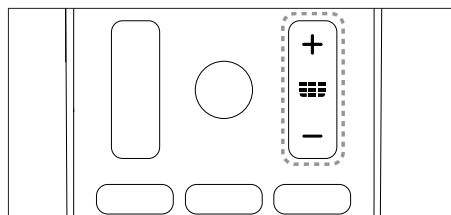
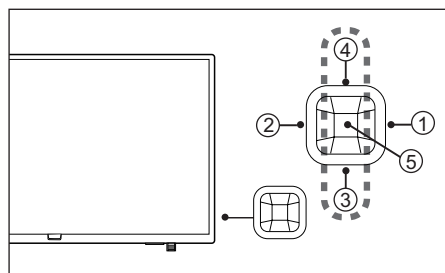

- Press CH+/- on the remote control or the lower right section of the TV.
- Enter a channel number using the numeric buttons on the remote control.
- Press **↶** on the remote control to switch and return to the previous channel.

## View installed channel

All available channels can be viewed in the channel list.

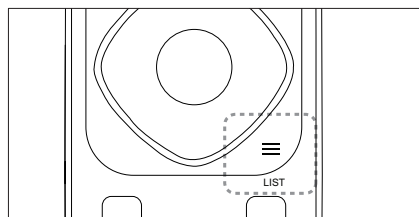

- 1 Press **≡** LIST.
  - ↳ The channel list appears.
- 2 Press **▲▼** to select channels and to browse the channel list.
- 3 Press **OK** to watch the selected channel.
- 4 Press **↶** to switch and return to the last watched channel.

## Watch connected devices

### Note

- Switch on the device before selecting it as an external signal source.

## Use the Sources button

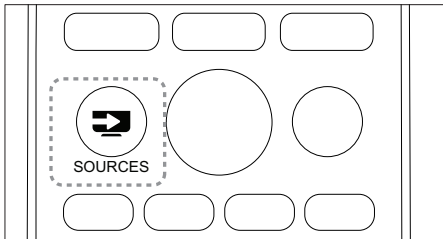

- 1 Press **SOURCES**.  
↳ The source list appears.
- 2 Press **▲▼** to select a device.
- 3 Press **OK** to confirm.  
↳ The TV switches to the selected device.

## Adjust the TV volume

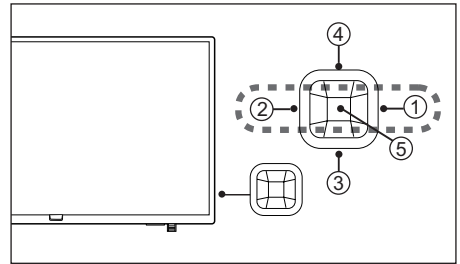

To increase or decrease volume

- Press **VOL +/-** on the lower right section of the TV or the **Volume control +/-** on the remote control.

To mute or unmute sound

- Press **🔇 (Mute)**.
- Press **🔊** again to restore the sound.

## 5 Other uses of the TV

### Accessing the TV menu

The menu helps you set up channels, change the picture and sound settings, and access other functions.

- 1 Press **Home** .  
↳ The menu screen is displayed.

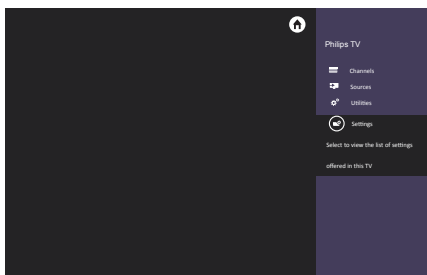

- 2 Select **[Setting]**.
- 3 Press **▲▼◀▶** to select from the following options:
  - **[Picture]** / **[Sound]** / **[TV]** (only shown in TV mode) / **[Settings]** / **[Parental]** (only shown in TV mode) / **[EasyLink]**.
- 4 Press **OK** to confirm.
- 5 Press **Home** to exit or return to the previous menu.

### Changing the picture and sound settings

You can change the picture and sound settings to suit your preferences. You can use the preset settings or manually adjust the settings.

### Adjusting the picture settings

- 1 Press **Home** and select **[Setting]** to enter the **[Setting]** menu. Then select **[Picture]**.  
↳ The **[Picture]** menu is displayed.
- 2 Press **▲▼◀▶** to select/adjust the settings:
  - **[Smart Picture]:**
    - **[Standard]:** standard picture settings. This option is recommended for home entertainment use.
    - **[Vivid]:** increases the contrast and sharpness of the picture.
    - **[Movie]:** applies to film settings and works best in a home cinema environment.
    - **[Natural]:** increases the softness of the picture.
    - **[Personal]:** you can customise your settings with this option.
  - **[Brightness]:** adjusts the intensity and detail of dark areas (the adjustments made can only be saved in personal settings).
  - **[Video Contrast]:** adjusts the intensity and detail of bright areas, while dark areas remain unchanged (the adjustments made can only be saved in personal settings).
  - **[Color]:** adjusts the colour saturation (the adjustments made can only be saved in personal settings).
  - **[Tint]:** adjusts the level of green (this option only appears when using the NTSC system).
  - **[Sharpness]:** adjusts the sharpness of the image (the adjustments made can only be saved in personal settings).
  - **[Color Temperature]:**
    - **[Cool]:** gives a bluish-white hue.
    - **[Normal]:** gives a white hue. Users can customise the white hue when in PC mode.
    - **[Warm]:** gives a reddish-white hue.
  - **[Advance Control]:**
    - **[Noise Reduction]:** filters and eliminates signal noise in the image.
    - **[Backlight]:** adjusts the screen brightness (when the backlight is set to a low value, a brief white flicker may be seen when switching the TV on. This is normal).
    - **[Dynamic Contrast]:** sets the contrast to maximum.
    - **[Dynamic Backlight]:** the contrast changes with the brightness of the image.

#### Note

- Options may vary for pictures from different sources.

---

## Adjusting the sound settings

- 1 Press **⬆** (**Home**) and select **[Setting]** to enter the **[Setting]** menu. Select **[Sound]**.  
↳ The **[Sound]** menu is displayed.
- 2 Press **▲▼◀▶** to select and adjust the settings:
  - **[Smart Sound]:**
    - **[Standard]:** gives balanced, outstanding sound performance in the treble, mid and bass ranges.
    - **[Music]:** enhances treble and bass, delivering bright, clear, pure sound for piano or orchestral instrument performances.
    - **[Movie]:** enhances film sound effects, allowing you to enjoy a home cinema-like effect.
    - **[Speech]:** enhances the performance of sound ranges associated with the human voice spectrum. This option is suitable for watching news or arts programmes.
    - **[Flat]:** enhances the smoothness of the sound output, creating a softer sound.
    - **[Personal]:** provides users with customisation functions so that all sound effect parameters are optimised to create the best possible experience.
  - **[Balance]:** adjusts the balance of the left and right speakers.
  - **[Bass]:** adjusts the base level (the adjustments made can only be saved in personal settings).
  - **[Treble]:** adjusts the treble level (the adjustments made can only be saved in personal settings).
  - **[Virtual Surround]:** enables virtual surround sound: switching on or off.
  - **[AVL]:** turns automatic volume adjustment on when switching channels.
  - **[SPDIF MODE]:** selects the coaxial output mode.
  - **[Audio Delay]:** delays the sound output.
  - **[TVSpeakers]:** turns sound on the TV on and off.
  - **[Clear Sound]:** turns speech on and off.
  - **[TV Placement]:** adjusts the means of the TV placement.

---

## Function settings

- 1 Press **⬆** (**Home**) and select **[Setting]** to enter the **[Setting]** menu. Then select **[Settings]**.  
↳ The **[Settings]** menu is displayed.
- 2 Press **▲▼◀▶** to select and adjust the settings:
  - **[Menu Language]:** adjusts the language settings of the TV.
  - **[Picture Format]:** the majority of signals use 16:9, 4:3, zoom 1 and zoom 2 formats. HDMI signal sources use 16:9, 4:3, Point to Point, zoom 1 and zoom 2 formats.
  - **[Menu Timeout]:** sets how long the menu is displayed.
  - **[Blue Screen]:** sets the colour of the screen when the TV receives no signal (when the TV signal is not functioning).
  - **[Auto Sleep]:** sets how long the TV must be idle for before switching off automatically (not applicable to PC mode).
  - **[Sleep Timer]:** sets when the TV automatically enters standby mode. The options are: off/10/20/30/60/90/180 minutes..
  - **[Time Setup]:** sets the system time.
  - **[Freeze Switch]:** sets the freeze screen for switching channels (only available in TV mode).
  - **[TTX Language]:** sets the Teletext language (only available in TV and video modes).
  - **[Color System]:** sets the AV colour system (only displayed in AV mode).
  - **[HDMI Mode]:** sets the HDMI mode (only displayed in 480p/576p/720p/1080p HDMI modes).
  - **[PVR File System]:** before carrying out PVR operations, the USB flash drive must be formatted and memory space allocated.
  - **[Enable OAD Upgrade]:** enables and disables OAD updates.
  - **[Reinstall TV]:** restores all settings to default and reopens the installation wizard menu.
  - **[Reset]:** restores the default settings (excluding password settings and channel information).
  - **[Software Version]:** checks the current software version.

## Changing the picture format

- 1 Press **⏠** (Home) and select **[Setting]** to enter the **[Setting]** menu. Then select **[Settings]**.
- 2 Press **▲▼◀▶** to select **[Picture Format]**.
- 3 Select a picture format.
- 4 Press **OK** to confirm.

## Summary of picture formats

The following picture formats can be configured.



### Note

- Some picture settings may be unavailable due to differences between picture signal formats.



**[16:9]**: adjusts the normal standard ratio to a widescreen format.



**[4:3]**: the normal standard format.



**[Zoom 1]**: horizontal scaling for the widescreen picture format. When this format is used, the left and right of the frame will be partially cut off.



**[Zoom 2]**: adjusts the standard ratio to a widescreen format (only 16:9, 4:3 and Point to Point options are available in PC mode).



**[Point to Point]**: used for HDMI connections with PCs. This displays the full PC screen to achieve the best display results.

## Using the timer

You can set the timer to switch the TV to standby mode at a set time.



### Tip

- Set the sleep timer before using the timer function.

## Setting the sleep timer



### Tip

- You can turn the TV off in advance or reset the sleep timer when the timer is up.

- 1 Press **⏠** (Home) and select **[Setting]** to enter the **[Setting]** menu. Then select **[Settings]**.
- 2 Press **▲▼◀▶** to select **[Sleep Timer]**.
- 3 Press **▲▼** to select a time for the sleep timer to switch the TV off.
  - ↳ The longest time that the sleep timer can be set for is 180 minutes.

## TV lock

By locking the TV remote control, you can prevent children from watching specific programmes or channels.

## Setting or changing your password

- 1 Press **⏠** (Home) and select **[Setting]** to enter the **[Setting]** menu. Then select **[Parental]**.
- 2 Enter the password using the numeric buttons on the remote control.
- 3 Select **[Change Password]** and follow the instructions onscreen to change the password.

## Locking channels

- 1 Press **⏠** (Home) and select **[Setting]** to enter the **[Setting]** menu. Then select **[Parental]**.
- 2 Enter the password and select **[Parental Rating]**.
- 3 Adjust the channel locking rating.

## 4 Repeat this step to adjust the channel ratings.

- **[Parental Rating]:** when channels are locked:
  - Enter the four-digit password to access the channel blocking menu.
  - Enter the four-digit password to view locked channels.
  - Enter the four-digit password to access the parental lock menu.
- **[Clear All]:** this function will clear all previously saved locked channels and signal sources.
  - The default password is '0000'. Users may change or set the password themselves.



### Note

- If you go to a locked channel, you will be prompted to enter the password.

## Playing multimedia files from USB devices

You can play photo, music or video files stored on a USB storage device on your TV.

- Supported storage devices: USB (only FAT or FAT 32 USB storage devices are supported)
- Supported multimedia file formats:
  - Images: JPEG
  - Audio: MP3
  - Video: MPEG 2/MPEG 4, H.264
  - Documents: TXT



### Note

- TPVision assumes no responsibility if a USB storage device is not supported, or if the data on the device is damaged or lost.

## Viewing photos and text files and playing audio and video files

- 1 Turn the TV on.

- 2 Connect the USB storage device to the USB port on the side of the TV.

- 3 Press  (**SOURCES**).

- 4 Select **[USB]** and press **OK**.
  - ↳ The USB browser will open.



---

## Viewing photos

- 1 Select the photo within the USB browser and press **OK**. The photo will be enlarged to fill the screen.
  - Press **CH-** or **CH+** to see either the previous or the next photo.

---

## Starting slide shows

- 1 Select a photo or folder and then press **OK**. The photo will be enlarged to fill the screen.
  - ↳ The slide show will start playing from the selected photo.
- 2 Press the following buttons to control the playback of photos:
  -  or : play or pause
  - **CH-** or **CH+**: view either the previous or the next photo.

---

## Changing the slide show settings

To start playing a slide show, press  (**Option**) and select one of the following options, then press **OK**.

- **[Rotate]:** sets the images to rotate.
- **[Duration]:** sets the duration of the slide show.

---

## Listening to music

- 1 In the USB browser, select a song or album. Then press **OK** to begin playing.

---

## Changing the music settings

-  or : to play or pause.

- **⏮/⏭**: switches to the previous/next song.
- **⏮/⏭**: for rewinding or fast forwarding.

---

## Watching videos

- 1 Select the video file in the USB browser, then press **OK** to play the video.
- 2 The following buttons are used to control the film:
  - **▶** or **⏸**: to play or pause.
  - **⏮/⏭**: move to the previous or next one.
  - **⏮/⏭**: for rewinding or fast forwarding.

---

## Viewing text files

- 1 Select the text file in the USB browser, then press **OK** to view the document.
- 2 The following buttons are used to control the text playback:
  - **▶** or **⏸**: to play or pause
  - **⏮/⏭**: to go back 20 pages or move on 20 pages.

---

## Removing USB storage devices



### Note

- Follow the steps below to avoid damaging the USB storage device.

- 1 Hold down **↶** to exit the USB browser.
- 2 Wait around 5 minutes before removing the USB storage device.

---

## Updating the TV software

Philips constantly strives to improve its products, and so we recommend that you update your TV software whenever an update is released. Visit [www.philips.com/TVsupport](http://www.philips.com/TVsupport) to check whether updates are available.

---

## Restoring factory settings

You can restore the default picture and sound settings for your TV without affecting the saved channel set up.

- 1 Press **⌂** (**Home**) and select **[Setting]** to enter the **[Setting]** menu
- 2 Press **▲▼◀▶** Then select **[Settings] > [Reset]**.
- 3 Select **[Yes]** and press **OK**. If you wish to cancel, select **[No]** and press **OK**.

## 6 Setting up channels

This chapter explains how to reconfigure and fine-tune channels.

---

### Setting up channels automatically

This option automatically finds and saves channels.

- 1 Press **⏠** (Home) and select **[Setting]** to enter the **[Setting]** menu
- 2 Press **▲▼◀▶** to select **[TV] > [Channels] > [Channel Scan]**.
- 3 Press **OK**.  
↳ The TV will start searching for channels automatically.

---

### Swapping channels

- 1 Press **⏠** (Home) and select **[Setting]** to enter the **[Setting]** menu.
- 2 Press **▲▼◀▶** to select **[TV] > [Channels] > [Channel Edit]**.  
↳ The **[Channel Edit]** menu is displayed.
- 3 Press **▲▼** to select **the analogue channel you wish to swap**. Then press the **blue button**.
- 4 Press **▲▼** to select **the analogue channel you wish to swap**. Then press the **blue button** to confirm.

---

### Renaming channels

You can rename channels. Selecting a channel will display its name

- 1 Press **⏠** (Home) and select **[Setting]** to enter the **[Setting]** menu.
- 2 Press **▲▼◀▶** to select **[TV] > [Channels] > [Channel Edit]**.  
↳ The **[Channel Edit]** menu is displayed.
- 3 Press **▲▼** to select the analogue channel you wish to rename. Then press the **OK** button.
- 4 Press **▲▼** to select the channel name, then press the **OK** button to enter the editing interface.
- 5 Press **▲▼◀▶** to select the characters.
- 6 Select **[Confirm]** then **OK** to finish renaming the channel.



#### Tip

- Channel names can be up to six characters long.

---

### EPG

- 1 Press **!≡** (TV GUIDE) on the remote control to access TV program guide list (It is available only in DTV mode). In this program guide list, press **▲▼** to select the current time and date, and then press **◀ ▶** to view all programs information in the next 7 days of the future (Fig.1).



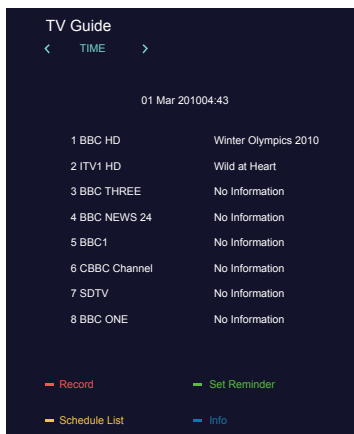

- 2 Press ◀▶ to select Channel in the top bar of guide list, then press ▲▼ to view a program information in the next 7 days of the future. Focus on the Channel bar you can press ◀▶ to view the other programs information (Fig.2).

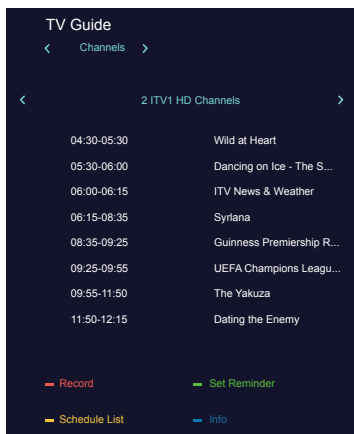

You can select the color keys to edit these programs with the tips on the screen. The color keys introductions as below:

- **Record:** Press ■ red key to record the program.
- **Remind:** Press ■ green key to set remind the program.

- **Info:** Press ■ blue key to display the program information.
- **Schedule:** Press ■ yellow key to view program status in schedule list.

## Recording option

In DTV mode, press ● red dot on the remote control. Record option menu will show on the screen, and the TV system begin recording now.

- 1 Press ■ key to stop and quit the recording.
- 2 Press ■ (Home), select **[Utilities]** > **[Recordings]** to open the TV recorded list.
- 3 Press ■ green key to view the file information or delete it by pressing ■ red key, and press **OK** to play it normally.



### Note

- This function need connect with USB device, the USB of FAT32 format must be used. The USB of NTFS format does not support recording. The duration of each recording should be no longer than 6 hours.

## Recording options menu introduction

- ▶: Play the current video.
- ◀◀: Fast back for the video, press ▶ (play) key to play normally.
- ▶▶: Fast forward for the video, press ▶ (play) key to play normally.
- ⏸: Pause the video.
- ■: Stop recording and quit the recording function.

## Time-shift option

In DTV mode, press ▶ (start), time-shift option menu will show on the screen, and the program is in suspended status. press ■ to stop and quit time-shift function. When you leave program for

a short time, time-shift function can suspend and cache the playing program to U disk. When you resume playing, the program can continue to be played.

---

## Time-shift options menu introduction

- ▶ : Play the current video.
- ◀◀ : Fast back for the video, press ▶ (play) key to play normally.
- ▶▶ : Fast forward for the video, press ▶ (play) key to play normally.
- || : Pause the video.
- ■ : Stop and quit time-shift function.

# 7 Connecting the TV

This section explains how to connect devices with different connectors.

## Note

- You can use different connection types to connect devices to the TV.

## Down ports

### ① AV input

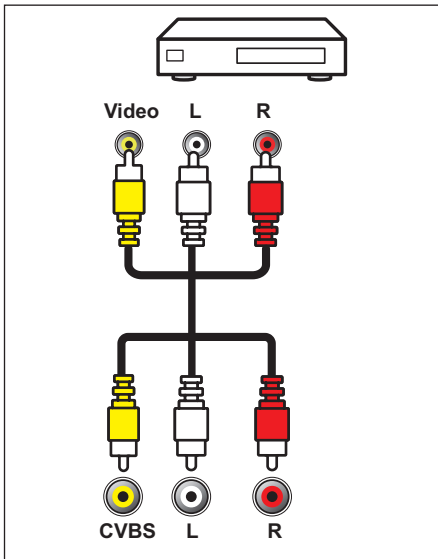

### ② HDMI 1

Digital audio and video input from high definition devices such as Blu-ray players.

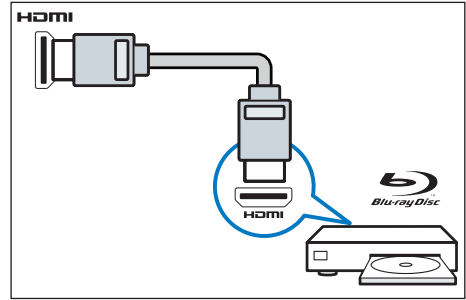

## Side ports

### ① HDMI 2 (ARC)

Digital audio and video input from high definition devices such as Blu-ray players.

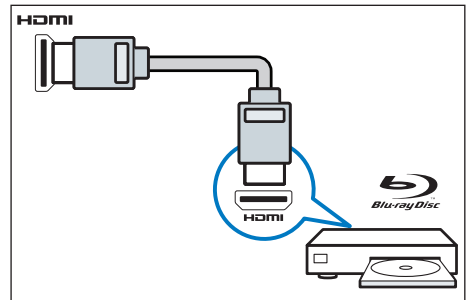

### ② SPDIF OUT

Digital audio signal output for digital audio equipment.

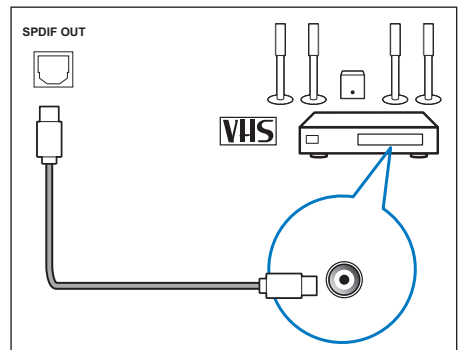

### ③ Antenna/cable TV

Input for an antenna, cable or satellite signal

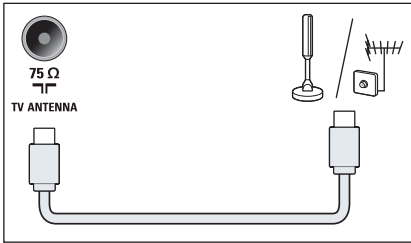

### ④ USB

Data input from a USB storage device.

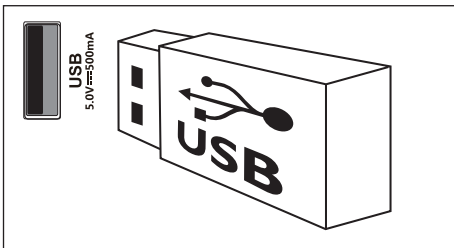

### ⑤ Headphones

Stereo sound output for headphones.

If you want to use headphone only, please turn off TV Speakers in advance.

Press **Home** > [Sound] > [TV Speakers] > [off].

#### Note

- Headphones can only be used as a low-power audio output. Do not connect high-power active devices (such as high-power active speakers).

## Connecting to a computer

Before connecting a computer to the TV:

- Set the computer screen refresh rate to 60 Hz.
- Select a supported screen resolution on the computer.

Connect to the computer using one of the following connections:

#### Note

- A separate audio cable is required when connecting via DVI.

- HDMI cable
- Set the resolution of the computer display to 480p/576p/720p/1080p
  - Press **Home** (Home) and select [Setting] to enter the [Setting] menu.
  - Press **Up/Down/Left/Right** to select [Settings] > [HDMI Mode], and set the HDMI display mode to graphics or video.
  - Adjust the picture format to achieve the best display results.
    - Press **Home** (Home) and select [Setting] to enter the [Setting] menu.
    - Press **Up/Down/Left/Right** to select [Settings] > [Picture Format].
    - Select a picture format.
    - Press **OK** to confirm.

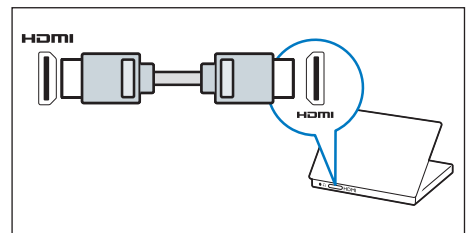

## Using Philips EasyLink

Making full use of your Philips EasyLink HDMI-CEC compatible devices can enhance control features to achieve the best possible results. HDMI-CEC compatible devices connected through the HDMI connector can be controlled by a TV remote control.

To enable Philips EasyLink, you will need to:

- Connect two or more HDMI-CEC compatible devices using HDMI connections.
- Make sure that each HDMI-CEC compatible device is operating normally.
- Switch to EasyLink.



### Note

- EasyLink compatible devices must be switched on and selected as a signal source.
- Philips does not guarantee 100% interoperability with all HDMI-CEC devices.

## Enabling or disabling EasyLink

Once an HDMI-CEC compatible device has been switched on, the TV will automatically turn on and switch to the correct signal source.



### Note

- Do not enable this function if you would prefer not to use Philips EasyLink.

- 1 Press **⏠** (**Home**) and select **[Setting]** to enter the **[Setting]** menu.
- 2 Press **▲▼◀▶** to select **[EasyLink] > [HDMI CEC]**.
- 3 Select **[Off]** or **[On]**, then press **OK**.

## Using One-touch Play

- 1 Once EasyLink has been enabled, press play on the device.
  - ↳ The TV will automatically switch to the correct signal source.

## Using One-touch Standby

- 1 Press **(Standby/On)** on the remote control.
  - ↳ The TV and all connected HDMI devices will automatically enter standby mode.

# 8 Product information

Product information is subject to change without notice. For detailed product information, please visit [www.philips.com/TVsupport](http://www.philips.com/TVsupport).

---

## Display resolutions

### Computer Formats

- Resolution - refresh rate:
  - 640 x 480 - 60Hz
  - 800 x 600 - 60Hz
  - 1024 x 768 - 60Hz
  - 1360 x 768 - 60Hz
  - 1920 x 1080 - 60Hz(32 inches TV is not supported)

### Video Formats

- Resolution - refresh rate:
  - 480i - 60Hz
  - 480p - 60Hz
  - 576i - 50Hz
  - 576p - 50Hz
  - 720p - 50Hz, 60Hz
  - 1080i - 50Hz, 60Hz
  - 1080p - 50Hz, 60Hz.

---

## Multimedia

- Supported storage devices: USB (only FAT or FAT 32 USB storage devices are supported).
- Compatible multimedia file formats:
  - Image: JPEG
  - Audio: MP3
  - Video: MPEG 2/MPEG 4, H.264
  - Document: TXT

---

## Audio output power

- 32PHT5505: 5W x 2
- 43PFT5505: 6W x 2

---

## Intrinsic resolution

- 32PHT5505: 1366x 768
- 43PFT5505: 1920x 1080

---

## Tuner/reception/transmission

- Aerial input: 75 ohm coaxial (IEC75)
- TV systems: PAL, DVB-T/T2
- Video playback: NTSC, SECAM, PAL

---

## Remote control

- Batteries: 2 x AAA

---

## Power supply

- Mains power: 110-240V, 50-60Hz
- Standby power:  $\leq 0.5$  W
- Ambient temperature: 5 to 40 degrees Celsius
- Power consumption:
  - 32PHT5505: 50W
  - 43PFT5505: 80W

## Supported TV mounts

To mount the TV, please purchase a Philips TV mount or any TV mount compliant with the VESA standard. To prevent damage to cables and connectors, be sure to leave a clearance gap of at least 2.2 inches or 5.5cm between the back of the TV to the wall.



### Caution

- Please follow all instructions provided with the TV mount. TP Vision Europe B.V. bears no responsibility for improper TV mounting that results in accident, injury or damage.

Model No.	Required Pixel Pitch (mm)	Required Mounting Screws
32PHT5505	100 × 100	4 × M6 (recommended length: 15 mm)
43PFT5505	200 × 100	4 × M6 (recommended length: 11 mm)

# 9 Troubleshooting

This section covers common problems and their accompanying solutions.

---

## General issues

### The TV cannot be switched on:

- Disconnect the power cable from the power outlet. Wait for one minute before reconnecting it.
- Check that the power cable is securely connected.

### The remote control is not working properly:

- Check that the remote control batteries are correctly inserted according to the +/- orientation.
- Replace the remote control batteries if they are flat or weak.
- Clean the remote control and TV sensor lens.

### The standby light on the TV is red and blinking:

- Disconnect the power cable from the power outlet. Wait for the TV to cool down before reconnecting the power cable. If the light continues to blink, please contact Philips Customer Care Centre.

### You forgot the code to unlock the TV lock feature

- Enter '3448'.

### The TV menu is in the wrong language.

- Change the TV menu to your preferred language.

### When turning the TV On/Off or to Standby, you hear a creaking sound from the TV chassis:

- No action is required. The creaking sound comes from the normal expansion and contraction of the TV as it cools down and warms up. This does not impact its performance.

---

## Channel issues

### Previously installed channels do not appear in the channel list:

- Check that the correct channel list is selected.

---

## Picture issues

### The TV is on, but there is no picture:

- Check that the antenna is properly connected to the TV.
- Check that the correct device is selected as the TV source.

### There is sound but no picture:

- Check that the picture settings are correctly set.

### Poor TV reception from the antenna connection:

- Check that the antenna is properly connected to the TV.
- Loudspeakers, unearthed audio devices, neon lights, high buildings and other large objects can influence reception quality. If possible, try to improve the reception quality by changing the antenna direction or moving devices away from the TV.
- If the reception on one particular channel is poor, please fine tune this channel.

### There is poor picture quality from connected devices:

- Check that the devices are connected properly.
- Check that the picture settings are correctly set.

### The TV did not save your picture settings:

- Check that the TV location is set to the home setting. This mode offers you the flexibility to change and save settings.

### The picture does not fit the screen; it is too big or too small:

- Try using a different picture format.

### The picture position is incorrect:

- Picture signals from some devices may not fit the screen correctly. Please check the signal output of the device.

---

## Sound issues

The pictures are showing but sound quality is poor:

### Note

- If no audio signal is detected, the TV automatically switches the audio output off - this does not indicate malfunction.



- Check that all cables are properly connected.
- Check that the volume is not set to 0.
- Check that the sound is not muted.
- Check that the sound settings are correctly set.

**The pictures are showing but sound comes from one speaker only:**

- Verify that sound balance is set to the centre.

---

## HDMI connection issues

**There are problems with HDMI devices:**

- Please note that HDCP (High-bandwidth Digital Content Protection) support can delay the time taken for a TV to display content from a HDMI device.
- If the TV does not recognise the HDMI device and no picture is displayed, please try switching the signal source to another device before switching it back again.
- If there are intermittent sound disruptions, please check that output settings from the HDMI device are correct.
- If you are using a HDMI to DVI adapter or cable, please check if the audio cable that comes with the product is connected to AUDIO (only for mini jacks).

---

## Computer connection issues

**The computer display on the TV is not stable:**

- Check that your PC uses the supported resolution and refresh rate.
- Set the TV picture format to unscaled.

---

## Contact us

If you cannot resolve your problem, please refer to the FAQs for this model at [www.philips.com/TVsupport](http://www.philips.com/TVsupport).

If the problem remains unresolved, please contact your local Philips Customer Service Centre.



### Warning

- Do not attempt to repair the TV yourself. This may cause severe injury, irreparable damage to your TV or void your warranty.



### Note

- Please make a note of your TV model and serial number before you contact Philips Customer Service Centre. These numbers are printed on the back/bottom of the TV and on the packaging.



This electrical and electronic product contains some hazardous substances. You may be safe to use it during the environment-friendly use period, and please hand it over to recycle system after environment-friendly use period exceeded.

## **Suggestive description of the Recycling Administrative Regulations for Waste Electrical and Electronics Products**

In order to care and protect the Earth in a better way, please adhere to the national and applicable laws in relation to the recycling management of waste electrical and electronics products when the user no longer needs to use this product, or when it has reached the end of its product life.

# 10 Warranty

English  
Warranty

Indonesia  
Jaminan

简体中文  
保修

Malay  
Waranti

Deutsch  
Garantie

ไทย  
การรับประกัน

繁體中文  
保養

Français  
Garantie

Tiếng Việt  
Bảo hành

العربية  
الضمان

## English - Guarantee

Dear Customer,  
Thank you for purchasing this Philips product. For the Philips warranty applicable to this product, we refer you to the Philips website [www.philips.com/guarantee](http://www.philips.com/guarantee). In the event you do not have an internet connection, please contact your local Philips Consumer Care Centre. Contact details are given in the Consumer Care Centres list hereafter:

## Deutsch - Garantie

Sehr geehrter Kunde, wir beglückwünschen Sie zu Ihrer Entscheidung für dieses Produkt von Philips. Nähere Informationen zu der für dieses Produkt geltenden Philips Garantie finden Sie im Internet unter [www.philips.com/guarantee](http://www.philips.com/guarantee). Die durch Philips gewährte Garantie beeinträchtigt in keiner Weise Ihre gesetzlichen Rechte. Sofern Sie keinen Zugang zum Internet haben, wenden Sie sich bitte an Ihr Philips Info-Center vor Ort. Die entsprechenden Kontaktdaten entnehmen Sie bitte der nachstehenden Liste.

## Français - Garantie

Cher client,  
Merci d'avoir acheté ce produit Philips. Pour connaître les conditions de garantie Philips applicables à ce produit, reportez-vous à la page [www.philips.com/guarantee](http://www.philips.com/guarantee). Si vous ne possédez pas de connexion Internet, contactez votre Service Consommateurs Philips local. Vous trouverez les coordonnées de tous les Services Consommateurs dans la liste ci-après. Ces informations étaient correctes à la date d'impression. Pour des informations à jour, consultez la page [www.philips.com/support](http://www.philips.com/support).

## Indonesia - Jaminan

Pelanggan yang terhormat,  
Terima kasih telah membeli produk Philips. Untuk mendapatkan jaminan produk ini, kunjungi situs Web Philips di [www.philips.com/guarantee](http://www.philips.com/guarantee). Jika Anda tidak memiliki sambungan Internet, hubungi Pusat Layanan Pelanggan Philips setempat. Rincian kontak tercantum dalam daftar Pusat Layanan Pelanggan.

## ไทย - การรับประกัน

เรียนลูกค้า  
ขอขอบคุณที่เลือกซื้อผลิตภัณฑ์ของ Philips สำหรับการรับประกันที่มีผลบังคับใช้กับผลิตภัณฑ์นั้น โปรดอ้างอิงเว็บไซต์ของ Philips [www.philips.com/guarantee](http://www.philips.com/guarantee) ในกรณีที่คุณไม่มีอินเทอร์เน็ต โปรดติดต่อศูนย์บริการลูกค้า Philips ประจำท้องถิ่นของคุณ รายละเอียดการติดต่อจะแสดงอยู่ในรายชื่อศูนย์บริการลูกค้าต่อไป

## Tiếng Việt - Bảo hành

Kính gửi Quý khách hàng,  
Cảm ơn quý vị đã mua sản phẩm Philips này. Để biết bảo hành của Philips có thể áp dụng cho sản phẩm này, chúng tôi xin giới thiệu trang web của Philips [www.philips.com/guarantee](http://www.philips.com/guarantee). Trong trường hợp quý vị không có kết nối internet, vui lòng liên hệ với Trung tâm Chăm sóc Khách hàng của Philips tại địa phương. Chi tiết liên hệ được cung cấp trong danh sách Trung tâm Chăm sóc Khách hàng sau đây:

## 简体中文 - 保证

尊敬的客户：  
感谢您购买此 Philips 产品。有关适用于此产品的 Philips 保修信息，建议您访问 Philips 网站：[www.philips.com/guarantee](http://www.philips.com/guarantee)。如果您无法访问 Internet，请联系您当地的 Philips 客户服务中心。将来，我们会在客户服务中心列表中提供详细联系信息。

## 繁體中文 - 保證

親愛的客戶，您好：  
多謝您購買本飛利浦產品。有關適用於本產品的飛利浦保養詳情，請瀏覽飛利浦網站：[www.philips.com/guarantee](http://www.philips.com/guarantee)。如您未能連線至互聯網，請與您當地的飛利浦消費者保養中心聯絡。聯絡詳情已詳列於之後的消費者保養中心清單中。

## العربية

### الضمان

عزيزي العميل،  
شكرا لكم على شراء هذا المنتج من Philips. لمعرفة شروط ضمان Philips الذي ينطبق على هذا المنتج، راجع موقع [www.philips.com/guarantee](http://www.philips.com/guarantee) في حال لم يكن لديك اتصالاً بالإنترنت، يرجى الاتصال بمرقم مركز خدمة العملاء المحلي لشركة Philips. يمكن معرفة تفاصيل الاتصال من قائمة مراكز خدمة العملاء فيما يلي.

## Inggeris-Jaminan

Pelanggan yang dihormati,  
Terima kasih kerana membeli produk Philips. Bagi waranti Philips yang terpakai untuk produk ini, kami merujuk anda kepada laman web Philips [www.philips.com/guarantee](http://www.philips.com/guarantee). Sekiranya anda tidak mempunyai sambungan Internet, sila hubungi Pusat Layanan Pelanggan Philips tempatan anda. Butiran kenalan diberikan dalam senarai Pusat Layanan Pelanggan selepas ini.





User Manual



FAQ



Chat



Forum



Call



Email



Warranty

[www.philips.com/support](http://www.philips.com/support)

Australia  
1300 998 851

Indonesia  
0800-1-822822

Philippines/Pilipinas  
632 84204970

Malaysia  
1800 220 180

Singapore/新加坡  
65 6286 7333

Thailand/ประเทศไทย  
0-2746-5431



All registered and unregistered trademarks are property of their respective owners.

Specifications are subject to change without notice. Philips and the Philips' shield emblem are trademarks of Koninklijke Philips N.V. and are used under license from Koninklijke Philips N.V. 2019 © TP Vision Europe B.V. All rights reserved.  
[philips.com](http://philips.com)