

Contents

Help?

If this instruction manual does not give an answer or if 'Tips' do not solve your TV problem, you can call your Local Philips Customer or Service Centre. See the supplied World-wide guarantee booklet. Please, have the Model and Product number which you can find at the back of your television set or on the packaging, ready, before calling the Philips helpline.

Model: 32PF9966/79
 32PF9966/98
 42PF9966/79
 42PF9966/98
 50PF9966/79
 50PF9966/98

Product No:

Care of the screen

See Tips, p. 22.

End of life directives

Philips is paying a lot of attention to producing environmentally-friendly in green focal areas. Your new TV contains materials which can be recycled and reused. At the end of its life specialised companies can dismantle the discarded TV to concentrate the reusable materials and to minimise the amount of materials to be disposed of.

Your TV contains a (tolerated) small amount of mercury. Please ensure you dispose of your old TV according to local regulations.

Preparation	2
Keys on the right side of the TV	2
Use of the remote control RC4302	3
To use the menus	5
Installation	5
Select the menu language	5
Store TV channels	5
Automatic installation	5
Manual installation	6
Give name	6
Reshuffle the programme list	6
Select Favourite TV channels	6
TV Setup	7
General	7
Source	9
Demo	9
TV menu	10
Picture menu	10
Active Control	11
Sound	11
Ambilight	12
Features menu	13
Dual screen / PIP / Multipip	14
Teletext	15
Switch Teletext on and off	15
Select a Teletext page	15
Previously selected teletext page	15
Select the index teletext page	15
Select subpages	15
Picture/Teletext	15
Enlarge a Teletext page	15
Hypertext	15
Teletext menu	16
Connect Accessory Devices	17
Recorder (vcr-dvd+rw)	17
Recorder and other A/V devices	17
DVD Player or other accessory digital source devices	18
Multi channel Surround receiver	18
HDMI (High Definition Multimedia Interface) connector	19
Connect extra subwoofer	19
Side connections	20
To select connected peripherals	20
Record with your recorder	20
Audio- and video equipment keys	21
Tips	22

Preparation

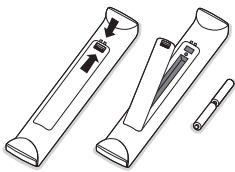
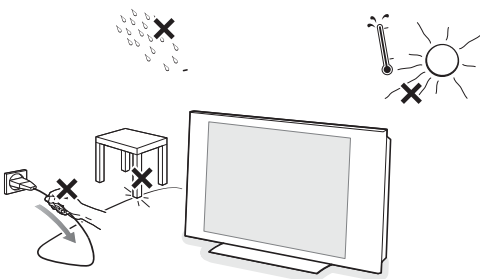

1 Wall mounting instructions/Stand

How to mount the supplied stand and/or wall mount bracket, see the supplied separate Quick Start Guide. Make sure that the wall mount is being fixed securely enough so that it meets safety standards. The weight of the TV (excl. packaging) is about 20 kg (32PF9966); 42 kg (42PF9966); 58 kg (50PF9966).

2 Place or hang the TV wherever you want, but make sure that air can circulate freely through the ventilation slots. Do not install the TV in a confined space such as a book case or a similar unit.

To prevent any unsafe situations, no naked flame sources, such as lighted candles, should be placed in the vicinity. Avoid heat, direct sunlight and exposure to rain or water. The equipment shall not be exposed to dripping or splashing.

3 Insert the aerial plug firmly into the aerial socket at the bottom of the TV. For best picture quality use the suppressor-aerial cable supplied.

4 To connect your computer, see p. 19.

To connect other peripherals, see p. 17.

In order to obtain the best result, please use only the supplied aerial cable between the TV and recorder, and between recorder and aerial connector.

5 Insert the mains cord supplied into the mains at the bottom of the TV and in the wall socket. Check that the mains supply voltage corresponds to the voltage printed on the sticker at the rear of the TV.

To prevent damaging the power (AC) cord which could cause a fire or electric shock, do not place the TV on the cord.

6 Remote control: Insert the 2 batteries supplied (Type R6-1,5V).

The batteries supplied do not contain the heavy metals mercury and cadmium. Please check on how to dispose of exhausted batteries according to local regulations.

7 Switch the TV on : Press the power switch at the right side of the TV. An indicator on the front of the TV lights up and the screen comes on. If the TV is in standby mode, press the **-P+** keys or the key on the remote control.

Keys on the right side of the TV

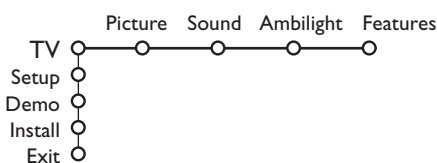
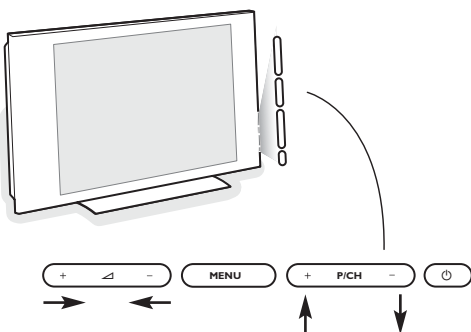

Should your remote be lost or broken you can still change some of the basic settings with the keys on the right side of your TV.

Press:

- the **+ ** - key to adjust the volume;
- the **+ P/CH -** key to select the TV channels or sources.

Press the **MENU** key to summon the main menu without the remote control.

Use:

- the **+ ** - key and the **+ P/CH -** key to select menu items in the directions as shown;
- the **MENU** key to confirm your selection.

Note:

When activated via the **MENU** key on the right side of the TV, only **Exit** lets you remove the menu.

Navigate to **Exit** and press the **MENU** key.

Use of the remote control RC4302

Note: For most keys pressing a key once will activate the function. Pressing a second time will de-activate it. When a key enables multiple options, a small list will be shown. Press repeatedly to select the next item in the list. The list will be removed automatically after 6 seconds or press **OK** to remove immediately.

Remark: in HDMI mode only some keys are valid.

AMP DVD/R TV SAT AUX

See 'Audio- and Video equipment keys', p. 21.

- ➔ **Select your peripherals**
See p. 20.



Audio and Video equipment keys, see p. 21.

🕒 Time display

The time is displayed on the screen.

🔊 Surround mode

Incredible surround

With stereo transmission, and when Incredible surround is selected, it seems as though the loudspeakers are spread further apart from one another.

Virtual Dolby Surround

Optimal with Dolby Surround signals. Enables you to experience the effect of Dolby Surround Pro Logic, reproducing a rear sound effect. See Sound menu, 3D effect, p. 11.

Note: You can make the same selection in the Sound menu, surround mode, p. 11.

🗣️ no function

📺 no function

⏸ Freeze

To freeze the picture. Dependent on the input signal, the function may not be possible.

📄 On Screen information

Press to display (when available) information about the selected TV channel and programme.

Menu info

When a menu is on screen, press **i+** to display info on the selected menu item.

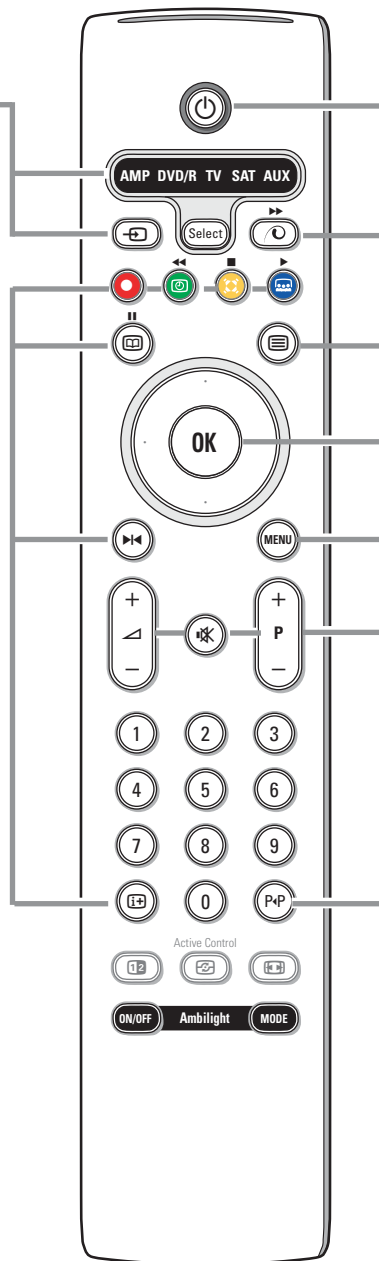

🔌 Standby

Press to switch the TV on or off from or to standby mode. When switched off, a red indicator on the TV lights up.

🕒 Pixel Plus 2 demo on/off

- Press to switch the Pixel Plus 2 demo on or off. In the right part of the screen Pixel Plus 2 is switched on.
- Press longer to display the list of digital options settings. Use the cursor up/down to select one of the settings. See also Picture menu, Digital options, p. 10.

📄 **Teletext On/Off** see p. 15

Cursor keys

Press the cursor keys up/down, left/right to navigate through the menus.

OK

- to activate your choice, when in the menus.
- to display the programme list.

MENU Main menu on/off see p. 5

🔊 To adjust the volume.

🔊 Interrupt the sound or restore it.

P Programme selection

To browse through the TV channels and sources stored in the favourite list.

0/9 Digit keys

To select a TV channel. For a two digit programme number, enter the second digit before the dash disappears. To switch immediately to a selected one digit TV channel, keep the digit key pressed a bit longer.



P+P Smart surf

With this key you can easily switch between 2 up to 9 different TV channels or sources. See General, Smart surf, p. 7.
Press the **OK** key or wait for the time out to dismiss the Smart surf display.

12 Dual screen / PIP / Multipip See p. 7 and 14.

13 Active control see p. 11.

14 Picture format

Press this key repeatedly or press the cursor up/down to select another picture format: Auto format, Super zoom, 4:3, Movie Expand 14:9, Subtitle zoom or Wide screen.

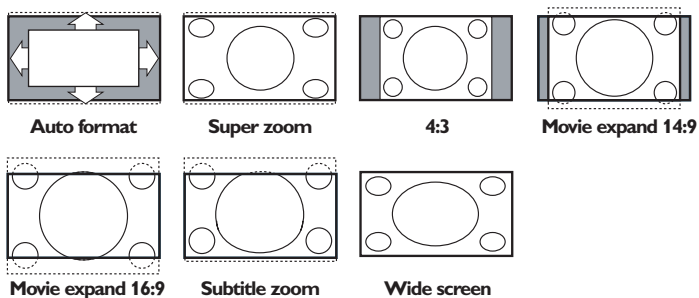

Auto format makes the picture fill the screen as much as possible.

In case of subtitles in the bottom black bar Auto format makes the subtitles visible.

In case of a broadcaster logo in the corner of the top black bar, the logo disappears from the screen.

Super zoom removes the black bars on the sides of 4:3 programs with minimal distortion.

When in Movie Expand 14:9, Movie Expand 16:9, Super zoom or Subtitle zoom picture format, you can make subtitles visible with the cursor up/down.

*Note: With signals via the **HDMI** connector or **HD** signals via **AV1** or **AV2** less picture formats are selectable.*

Ambilight see also p. 12.

- **ON/OFF** Press to switch Ambilight on or off.
- **MODE** Press repeatedly to select one of the predefined ambient light settings.

Note: When the TV is switched to standby, and you switch Ambilight On, Ambilight will be active. Only then less modes are available.

To use the menus

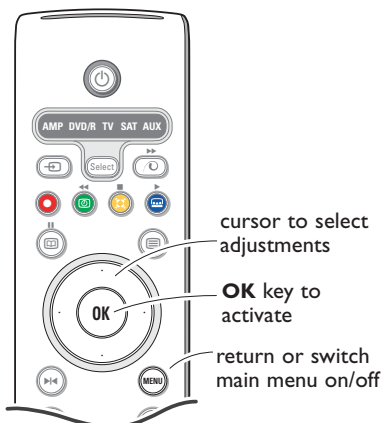

Press the **i+** key to get information about the selected menu item.

- 1 Press the **MENU** key on the remote control to summon the main menu. At any moment you can exit the menu by pressing the **MENU** key again.

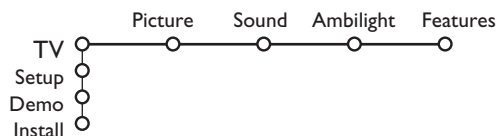

- 2 Use the cursor in the up/down direction to select the **TV**, **Setup**, **Demo** or **Install** menu. Use the cursor left/right to select **Picture**, **Sound**, **Ambilight** or **Features**.
Note: Sometimes not all the menu items are visible on the screen (indicated by a cluster of blue balls). Use the cursor down or right to reveal all items.
- 3 Use the cursor in the left/right direction to select the menu item.
- 4 Use the cursor up/down again to select the control you want to select or to adjust.

Note: Items temporary not available or not relevant are displayed in a light grey colour and cannot be selected.

Installation

The installation menu contains the following items:



Select the menu language

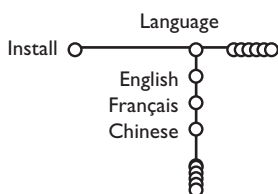

- 1 Press the **MENU** key on the remote control.
- 2 Use the cursor down to select **Install**.
- 3 Use the cursor right to select **Language**. Follow the instructions on screen.
- 4 Use the cursor up/down to select your preferred language and press the **OK** key to confirm your selection.
- 5 Proceed with the **Install** menu.

Store TV channels

After language is set correctly, you can now search for and store the TV channels in two different ways: using Automatic Installation or Manual Installation (tuning-in channel by channel). Select your choice with the cursor right.

Automatic installation

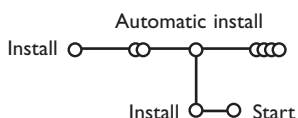

- 1 Select Automatic install in the Install menu.
Note: All channels must be unlocked in order to autoprogram. If requested, enter your code to unlock all channels. (See TV, Features menu, Childlock, p. 13.)
- 2 Press the cursor down. The autoprogramming option label **Start** appears.
- 3 Press the cursor right.
- 4 The message **Searching** appears and the progress of autoprogramming is displayed.

You can change the order of the stored TV channels. You can use Reshuffle to renumber them. See p. 6.

Manual installation

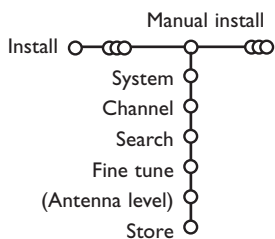

Searching for and storing TV channels is done channel by channel. You must go **through every step** of the Manual Installation menu.

- 1 Select **Manual install** in the Install menu.
- 2 Press the cursor down.
Follow the instructions on screen.

Search or direct selection of a TV channel:

If you know the frequency, enter the 3 or 2 digits of the frequency directly with the digit keys 0 to 9 (e.g. 048).

Repeat to search for another TV channel after you have stored the selected TV channel.

Give name

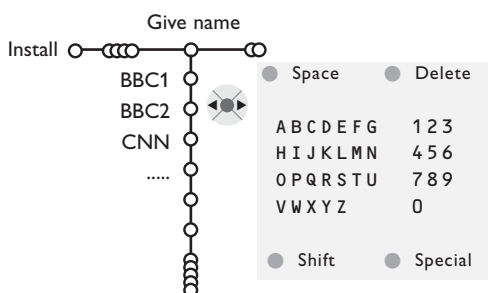

It is possible to change the name stored in the memory or to assign a name to a TV channel or external for which a name has not yet been entered. A name with up to 5 letters or numbers can be given to the channel numbers 0 to 99.

- 1 Select **Give Name** in the Install menu and press the cursor down.
- 2 Select the channel number.
Note: keep the cursor up/down pressed to scroll through the channel list quickly.
- 3 Press the cursor right.
A keyboard appears on the screen.
Note: Only European characters are displayed.
Press the cursor right to enter the keyboard.
Press the cursor up/down, left/right to select the first character and press **OK**. Repeat for every character you want to enter.
Select **Space** to enter a space; **Delete** to erase the highlighted character in the name entered; **Shift** to display upper- or lowercase characters on the keyboard; **Special** to display special characters on the keyboard.
Press **OK** to confirm.
- 4 Press the cursor left repeatedly when you have finished the name giving.
- 5 Select another channel number and repeat steps 3 to 4.

Reshuffle the programme list

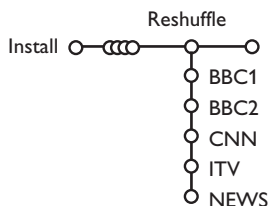

You can change the order of the stored TV channels.

- 1 Select **Reshuffle** in the Installation menu.
- 2 Follow the instructions on screen.

Select Favourite TV channels

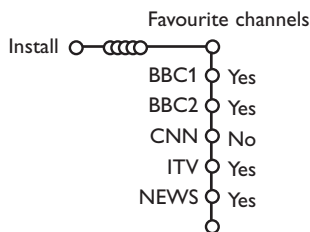

- 1 Select **Favourite channels** in the Install menu.
- 2 Select your channel number with the cursor up/down.
- 3 Select **Yes** or **No** with the cursor right.
- 4 Repeat 2 and 3 for every TV channel or external you want to make a favourite or a non-favourite TV channel or external.

TV Setup

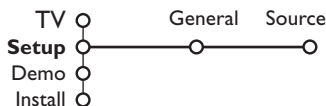

Press the **i+** key to get information about the selected menu item.

The Setup menu contains items that control the settings of the TV's functions, features, services and peripherals you may have connected.

The **General** menu allows you to change settings that will typically be accessed only occasionally.

The **Source** menu allows you to select a source.

General

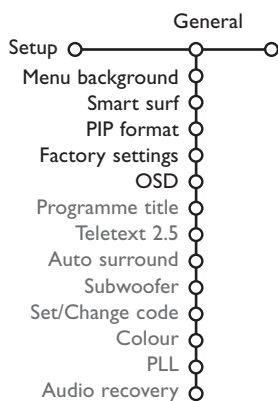

This menu allows you to change various settings that are presumably adjusted less frequently than most other settings.

Menu background

Select **Yes** or **No** to turn the menu background on or off.

Smart surf

- 1 Select **Smart surf**.
- 2 With the cursor left/right, select
 - **2 channels** if you want the P4P key to toggle between the current and the previously selected channel,
 - **9 channels** if you want the P4P key to summon a list of up to 9 channels which can be selected.

To add/remove a channel or source to the 9 channels list:

Tune to the channel or source you wish to add or remove. Press the P4P key and press the cursor right to add or remove.

Note: If there are already 9 channels/sources in the list, the one at the bottom of the list will be removed.

PIP format

This menu allows you to select the preferred format which can then be displayed toggling the **12** key on and off.

- 1 Select **PIP format** with the cursor down.
- 2 Press the cursor right.
- 3 Select **Dual screen**, **PIP**, **PIP 3** or **PIP 6** with the cursor down. When Dual screen mode is activated with the remote control **12** key, and when
 - **Dual screen** is selected, the TV splits the screen into two equally sized screens.
 - **PIP** is selected, the TV shows a full screen of video with a pip window of video on top if it;
 - **PIP3** or **PIP6** is selected, the TV will display the main screen together with 3 or 6 pip screens. See also p. 14.

Factory settings

This resets the picture and sound settings to their predefined factory values, but maintains the channel installation settings.

OSD (On Screen Display)

- 1 Select **OSD**.
- 2 Select **Normal** to activate the continuous display of the programme number and extended display of TV channel and programme information on screen. **Minimum** to activate the display of reduced channel information.

Note: When subtitles is switched on, see Features, p.13, display of the channel number is not possible

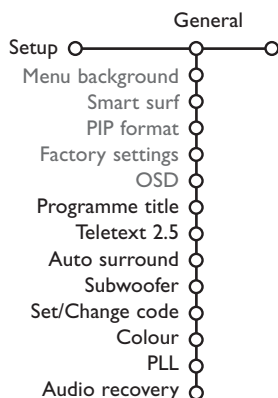

Programme title

Select **Programme title Yes** or **No**.

When selected **Yes**, after the selection of a TV programme or after pressing the **[+]** key on the remote control, a TV channel which broadcasts teletext may transmit the name of the TV channel or the programme title.

Teletext 2.5

Some broadcasters offer the opportunity to see more colours, other background colours and nicer pictures in the teletext pages.

- ❶ Select **Teletext 2.5**.
- ❷ Press the cursor right to select **Teletext 2.5 On** to take advantage of this feature.
- ❸ Press the cursor right again to select **Teletext 2.5 Off** if you like the more neutral teletext layout.

The selection made is valid for all channels which broadcast teletext 2.5.

Note: It may take a few seconds before teletext broadcast switches over to Teletext 2.5.

Auto Surround

Sometimes the broadcaster transmits special signals for Surround Sound encoded programmes.

The TV automatically switches to the best surround sound mode when **Auto Surround** is switched **On**.

Subwoofer

Select **Yes** if you installed an external subwoofer. See Connect Peripheral Equipment, Connect extra subwoofer, p. 20.

Set/Change code

The Child lock feature (see TV, Features, p. 13) allows you to lock channels to prevent others from watching certain programmes. To watch locked channels, a 4-digit code must be entered. The Set/Change code menu item allows you to create or change a Personal Identification Number (PIN).

- ❶ Select **Set/Change code**.
- ❷ If no code exists yet, the menu item is set to **Set code**. If a code has previously been entered, the menu item is set to **Change code**. Follow the instructions on screen.

Important: You have forgotten your code !

- ❶ Select **Change code** in the General menu and press **OK**.
- ❷ Press the cursor right and enter the overriding code 8-8-8-8.
- ❸ Press the cursor again and enter a new personal 4-digit code. The previous code is erased and the new code is stored.

Colour

Select **Colour** and press the cursor right.

If **Auto** is selected, the respective colour system will be automatically selected according to the transmission system.

(If the reception is poor, select another sound system with the cursor up/down.)

PLL

In rare cases certain TV channels may reproduce distorted or unstable pictures.

Select **PLL** (Phase Locked Loop) to switch to the setting 2 with the cursor left/right to restore the picture for the respective transmission.

Audio recovery

Rarely, and with certain TV channels, the broadcasted audio signal can be distorted. Select **Audio recovery On** to reduce distortion for that channel. This will also result in a lower volume level.

Source

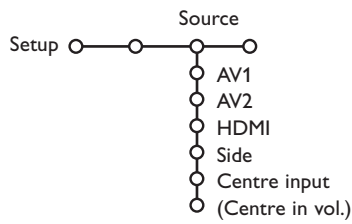

This menu allows you to indicate the peripheral you connected to one of the external inputs.

- 1 Press the cursor right to enter the list of types of peripherals attached to the selected input.
- 2 Select the peripheral device with the cursor up/down.

Once you have selected the source type, e.g. DVD, this source will automatically be selected when your remote control is in DVD mode, see p. 3, and when you press the key on the remote control.

Centre input - Centre in volume

When you have connected a surround receiver to the TV, see p. 18, the loudspeakers of the TV can act as centre speaker, making a separate centre speaker unnecessary.

Select **Centre input On**.

When having selected **On**, you can adjust the **Centre in volume** with the cursor left/right to correct volume level differences of the external audio receiver and speakers.

Demo

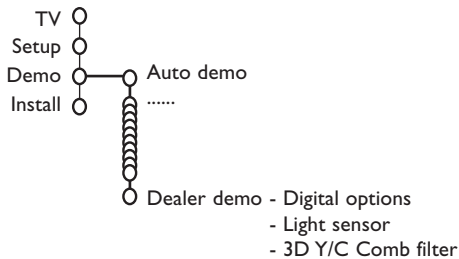

The Demo menu allows to demonstrate the TV features separately or in a loop.

Toggle through all the Ambilight modes will display each mode for 10 seconds each. Before switching to the next mode the light will first fade to off and then fade up in the next mode.

If **Auto demo** has been selected the demo will automatically present the features sequentially in a loop. Press one of the cursor keys to stop the Auto demo.

If one of the features has been selected, this particular feature demo will run only once, and the Demo menu will reappear. Ambient light (Ambilight) demo however will run continuously until it is stopped by pressing one of the cursor keys or the **OK** key on the remote control.

Note: The Dealer demo is not part of the automatic sequence and can only be activated separately.

TV menu

Press the **i+** key to get information about the selected menu item.

Press the **MENU** key on the remote control to summon the main menu.

Note: Dependent on the input signal, one or more menu items may not be selectable.

Picture menu

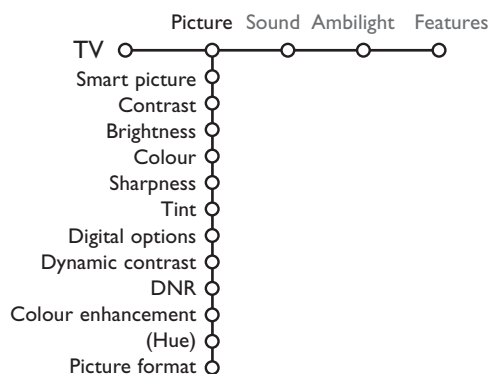

- 1 Press the cursor right to select **Picture**.
- 2 Select the menu items in the Picture menu with the cursor up/down.
- 3 Adjust the settings with the cursor left/right or enter the list of submenu items with the cursor right. Select a submenu item with the cursor up/down.

Note: To remove the menu background before adjusting the picture settings, see *Select TV setup, General, p. 7*.

Smart picture

Select **Smart picture** to display a list of predefined picture settings, each corresponding with specific factory settings.

Personal refers to the personal preference settings of picture in the picture menu.

Note: this Philips TV has been set at the factory to look best in bright store environments which use fluorescent lighting. As your home will likely not be as well lit as a store, we recommend that you cycle through the various **Smart Picture** modes to find the one that best suits your own viewing conditions. Most consumers will find that **Natural** is the correct choice. In case of weak RF/AV signals, please select **Soft**.

Digital options

Pixel Plus 2 is the most ideal setting, doubles the horizontal resolution and increases the number of lines by 33%.

You may consider to select Movie Plus in case a halo effect should disturb you. Dependent on your own preference, select Progressive scan.

Dynamic contrast

Sets the level at which the TV automatically enhances the details in dark, middle and light areas of the picture.

DNR

This sets the level at which noise is measured and reduced in the picture.

Colour enhancement

This makes the colours more vivid and improves the resolution of details in bright colours.

Hue

This compensates for the colour variations in NTSC encoded transmissions.

Picture format

This will adjust the size of the picture dependent on the broadcast format and your preferred setting.

See *Use of the remote control, p. 4*.

Active Control

Active control is a pro-active and automatic system. The TV continuously measures and corrects all incoming signals in order to provide the best picture possible. Thanks to the Ambient Light Sensor which measures the light conditions of the room, the contrast, dynamic contrast, brightness and colour picture settings are adjusted automatically. The light sensor is active when the Active control function is switched to Medium or Maximum.

Press the  key repeatedly to select the Active Control values Off, Minimum, Medium (recommended) or Maximum.

Off Sharpness and Dynamic Contrast are controlled automatically.

Minimum Sharpness, Dynamic Contrast and Noise Reduction are controlled automatically.

Medium Sharpness, Dynamic Contrast, Noise reduction and Colour are controlled automatically.

Maximum Sharpness, Dynamic Contrast, Noise reduction, Colour and Contrast are controlled automatically.

Press the cursor right to select **INFO+**.

The Active Control demo menu appears.

The picture settings are being adapted continuously and automatically.

The menu items cannot be selected.

The sliders will be moving, showing how the TV is tweaking the current picture. None of the sliders is user controllable.

Press the **OK** key to switch off the Demo..

Sound

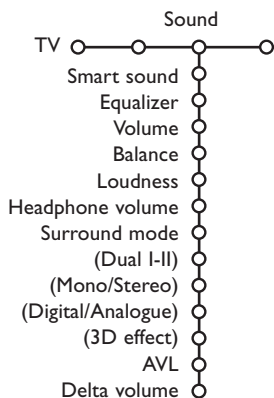

① Press the cursor right to select **Sound**.

② Select the menu items in the Sound menu with the cursor up/down and adjust the settings with the cursor left/right. Remember, control settings are at normal mid-range levels when the bar scale is centred.

Smart sound

Select **Smart sound** to display a list of predefined sound settings, each corresponding with specific factory settings of Treble and Bass.

Personal refers to the personal preference settings of sound in the sound menu.

Notes:

- Dual **I-II** is only available with dual sound transmission.
- Mono/Stereo is only selectable in case of analogue stereo transmission.
- Digital/Analogue is only selectable in case of Digital transmission.

Ambilight

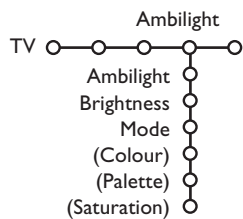

Press the **i+** key to get information about the selected menu item.

Colour modes:

- **Personal:** Select any Colour or hue to match to your personal taste, e.g. your interior, the program content (sports, movie, etc.), the mood you are in, etc.
- **Warm white:** The Colour is matched to that of most normal lightbulbs. Select this setting if you want the Ambilight to fit best with normal living room lighting.
- **Cool white:** The Colour is matched to that of normal daylight (6500K). Select this setting if you prefer more cool lighting.
Note: the 6500 K is the SMPTE recommended setting for ambient backlighting of displays.
- **Blue:** The blue Colour is preferred by most consumers to create a cool, modern and /or mystical atmosphere. Select this setting according to your personal taste or mood.

Ambilight is an innovative lighting concept using light with fully adjustable colours at the back of the TV to enhance the viewing experience. Analysis of the picture content adapts the colours continuously, or the lights can be set to any fixed colour and many shades of white. Ambilight creates the ideal viewing environment for your TV resulting in improved relaxed viewing, improved perceived picture detail, contrast and colour.

In standby mode the lights can be set/operated to any colour and create a unique ambience in the room.

- 1 Select **Ambilight** in the TV menu.
- 2 Press the cursor down to enter the Ambilight menu.
- 3 Select **Ambilight** and press the cursor right to select **Off** or **On**.
 - **Off:** will switch off the ambient lights and downlight all other menu items.
 - **On:** the ambient lights will be on. Refine the light settings in the menus below.
- 4 Select **Brightness** to adjust the light output of the ambient lights.
- 5 Select **Mode** and press the cursor right to select **Colour**, **Ambience**, **Relaxed**, **Movie** or **Action**.
 - **Colour:** this will show constant light according to the settings in the Ambilight colour menu. See below.
 - The options **Ambience**, **Relaxed**, **Movie** and **Action** will dynamically match brightness and colour to the screen content. The mode selection made will effect the speed and/or saturation and/or intensity which determines the viewing impression. E.g. in **Relaxed** mode, the rate of brightness and colour change is smoothly and soft which gives you a more immersive yet relaxed viewing. **Ambience** is the rate of brightness and colour change as predefined in the factory. **Movie** will influence the perception of a movie whereas **Action** mode will influence the dynamic impression.

Notes:

- The rate of change is limited, as not to cause uncomfortable sensations.
- According to the selection made, some Ambilight menu items will be downlighted and can not be selected.

- 6 In case **Colour** has been selected in the Mode menu:
 - Select **Colour** in the Ambilight menu and press the cursor right.
 - Select **Personal**, **Warm white**, **Cool white** or **Blue**.
 - Select **Palette** to select the general colour of the light.
 - Select **Saturation** to adjust the colourfulness of the light.

Notes:

- Adjusting the Palette and/or Saturation settings will set the colour mode to Personal.
- The selected Colour mode will be the one used when turning on the ambient lights from standby.

Ambilight in Standby mode

When the TV is switched off, the ambient lights will also be switched off.

When the TV is in standby mode, ambilight can be used to provide a unique ambience for the room. Press the ambilight on/off key on the remote control to switch between Ambilight Off or On.

Infrared interference on external devices

To avoid bad remote control reception, place your external devices out of sight of the ambient lights of your TV set.

Note: Ambilight does not function well when the room temperature is less than 15°C.

Features menu

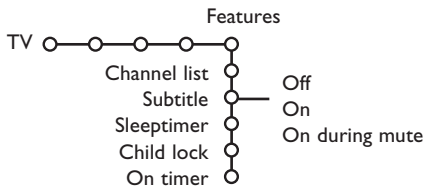

Press the **i+** key to get information about the selected menu item.

- 1 Press the cursor right to select **Features**.
- 2 Select the menu items with the cursor up/down and adjust the settings with the cursor left/right.

Channel list

Press the **OK** key to switch over to the selected TV channel or external.

Select subtitles

The subtitle page must be stored for each TV channel: Switch on teletext and select the proper subtitle page from the index. Switch off teletext.

Subtitle On will automatically display them on the selected TV channels if subtitles are in the transmission. A symbol will indicate that the mode is on. Select **On during mute** when you want to have the subtitles automatically displayed only when the sound has been muted with the **MUTE** key on the remote control.

Sleeptimer

This sets a time period after which the TV automatically switches to standby.

Child lock

- 1 Select **Child lock**.
- 2 Press the cursor right to enter the Child lock menu. You're summoned to enter your code.
Note: You have to re-enter your code each time you enter the child lock menu.

Important: You have forgotten your code ! See p. 8.

- 3 Select one of the menu items of the child lock menu:
 - **Lock** if you want to lock all channels and externals.
 - **Custom lock** and press the cursor right.
 - Select **Channel lock** if you want to lock a certain TV channel or external.
 - Select **Unlock** to disable all locks you have set.

On timer

From either standby or on, this automatically switches the TV to the specified programme number, at the specified time.

- 1 Select **On timer** with the cursor down.
- 2 Select **On** with the cursor right.
- 3 Press the cursor right again to enter the programme list.
- 4 Select the TV channel or external you want your TV to switch to on a selected time and day.
- 5 Press the cursor right again to select a day of the week or to select **Daily**.
- 6 Press the cursor right once again to enter the time with the digit keys or with the cursor up/down and press the **OK** key to activate.
- 7 Press the **MENU** key to turn off the menu.

Notes:

- To check your timer settings, press the **i+** key.
- Only one On timer can be set.

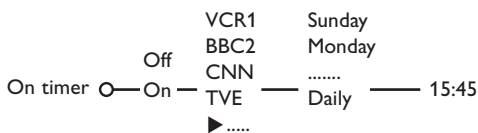
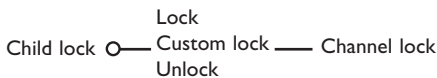

Dual screen / PIP / Multipip



Press the **12** key to switch on **Dual screen, PIP** or one of the PIP modes according to the format selection made in the PIP format list in the General menu. See Setup, General, p. 7.

Press the **12** key again. The screen that has a yellow border will become the full main screen picture.

Notes:

- Continuing to hold the **12** key down will cycle the TV through the various formats (Dual screen, PIP, PIP 3 or PIP 6), launching a new format after each second the key is held down. After standby of the TV, the preference as set in the Setup, General menu is used.
- It is not possible to display a HD source in a Dual screen/PIP screen.
- When Dual screen mode is selected, two picture formats are supported: Full screen or 4:3 letterbox picture format (vertical squeeze).
- Audio from the right screen or the PIP plays to the headphones.

Display options

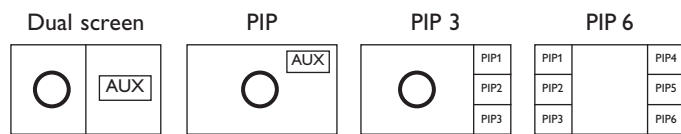

- Press the cursor right to highlight the right screen.
- Press the cursor down to highlight the single PIP screen.
- Press the cursor right to enter the Multipip screen and then use the cursor keys to navigate through the PIP screens and to highlight a PIP screen.

Changing TV channels or external sources in left, right, PIP or Multipip screen

- Press the **-P+** keys or the **P+P** key or the digit keys in order to change the TV channels or external sources in the highlighted screen.

Scan PIP3 or PIP 6

Navigate to the lowest PIP and press the cursor down to display a following series of PIP screens.

Define the position and the size of the single PIP screen

- 1 Select a Dual screen mode with a single PIP screen.
- 2 Press the cursor down to highlight the PIP screen. A PIP menu appears with which you can define the position and the size of the PIP screen.
*Note: When the PIP menu times out, press the **OK** key to make it reappear.*
- 3 Press the cursor down again to select **Position** or **Size**.
- 4 Press the **OK** key or the cursor right to activate.
- 5 Use the cursor keys to define the position of the PIP screen. Use the cursor left/right to define the size of the PIP screen.
- 6 Press the **OK** key. The PIP menu reappears.
- 7 Press the cursor up to the top of the menu to highlight the main screen again.
- 8 Press the **OK** key to switch off the menu or wait until it is timed out.

On-Screen information

The highlighted On-Screen information, which appears when changing channels, always refers to the active screen.

Teletext

Most TV channels broadcast information via teletext. This TV has a 1200 pages memory that will store most broadcasted pages and subpages to reduce waiting time. After each programme change, the memory is refreshed.

Switch Teletext on and off

Press  to switch the teletext on.



The screenshot shows a teletext page with the following content:

```
102 <<03 04 05 06 07 08 09 10 11 12>>
BBC CEEFAX 102 Mon 05 Feb 16.35.22
BBC CEEFAX
LIONS RECORD ANOTHER WIN 430
Index 100 News 300
BBC Info 110 Headlines 305
Children 120 Weather 400
Cookery 150 Sports 415
Education 200 Radio 500
Lottery 230 Travel 550
Finance 240 Subtitling 888
Music 280 TV Listings 600
Red Green Yellow Blue
```

Select a Teletext page

- Enter the desired page number with the digit keys, the cursor keys up/down, left/right or with the **-P+** key.
- Select the options at the bottom of the screen with the colour keys.

Previously selected teletext page

(Only possible in case there is no list of favourite teletext pages available. See p. 16.)

Press the **P*P** key.

Select the index teletext page

Press the grey colour key  to display the main index (usually p.100).

Only for T.O.P teletext broadcasts :

Press . A T.O.P. overview of the teletext subjects available is displayed.

Select with the cursor up/down, left/right the desired subject and press the **OK** key.



Not all TV channels broadcast T.O.P. teletext.

Select subpages

When a selected teletext page consists of different subpages, a list of available subpages appears on the screen.

Press the cursor left or right to select the next or previous subpage.

Picture/Teletext

- 1 Press the  key. Press the  key to show Teletext on the right of the screen.
- 2 Press the  key to switch off dual screen.

Enlarge a Teletext page

Press  repeatedly to display the upper teletext part, the lower teletext part and then to return to the normal teletext page size. When the teletext page is enlarged, you can scroll the text, line by line using the cursor up/down.

Hypertext

With hypertext you can quickly jump to a pagenumber or search for a specific word shown on the current teletext page.

- 1 Press the **OK** key to highlight the first word or a number on the page.
- 2 Use the cursor up/down, left/right to select any other word or number you want to search for.
- 3 Press the **OK** key to confirm. The search starts. A message appears at the bottom of the screen to indicate the searching, or that the word or page is not found.
- 4 Use the cursor up to exit hypertext.

Teletext menu

- 1 Press the **MENU** key to activate the menu.
- 2 Press the cursor up/down to select the menu items.
- 3 Press the cursor right to activate.

Reveal

Reveals/conceals hidden information on a page, such as solutions to riddles and puzzles.

Press the cursor right to activate.

Favourite

You may create a list of eight favourite teletext pages in total, selected from various TV channels.

To add a favourite page to the list:

- 1 Select a favourite teletext page.
- 2 Select **Favourite** in the teletext menu and press the cursor right to enter the list.
- 3 Press the cursor right again to add the page.
- 4 Press the **MENU** key to watch the current page.

To watch a favourite page from the list:

When in Teletext, use the P+P key to browse through the favourite pages of the TV channel actually selected.

Note: only the pages of the current channel can be selected.

Search

Selecting a word

On the keyboard on screen you can type in a random word you want to search for in the teletext pages. Whether upper- or lowercase is used has no influence.



- 1 Press the cursor right to enter the keyboard.
- 2 Press the cursor left/right, up/down to select the characters, words or functions.
Note: Only European characters are displayed.
- 3 Press the **OK** key to confirm each character selected.
- 4 Select **Cancel** to cancel the word; **Space** to enter a space; **Delete** to delete the last character selected; **Shift** to switch between lowercase or capital characters; **Special** to display special characters on the keyboard and press the **OK** key.
- 5 Press the cursor left repeatedly to return to the Teletext menu again.

Searching a word

- 1 Type in the word on screen or select a word from the history list on the right and press **OK**.
- 2 Select **Accept** and press **OK** again. The message Searching appears.
- 3 To cancel the searching or to search for a new word, select **Keyboard** and press **OK**.
- 4 When a word is not found, a message appears. When the word is found, it is highlighted in the teletext page. To continue the search, press the **OK** key.

Cycle subpages (if available)

Makes the subpages cycle automatically.

Press the cursor right to activate and to de-activate again.

Timed page

To display a specific page from a selected TV channel at a certain time.

- 1 Press the cursor right and select **Yes** or **No**.
- 2 Enter the time and pagenumber with the cursor keys or the digit keys.
Note: Teletext does not have to remain switched on, but you should watch the TV channel you have selected the specific page from.
- 3 Press the cursor left to return to the TV menu again.

Connect Accessory Devices

There is a wide range of audio and video devices that can be connected to your TV. The following connection diagrams show you how to connect them to the TV.

AV1 can handle YPbPr, Y/C and CVBS (Y); **AV2** YPbPr (RGB), CVBS and Y/C; **HDMI (AV3)**; **Side**: CVBS and Y/C.

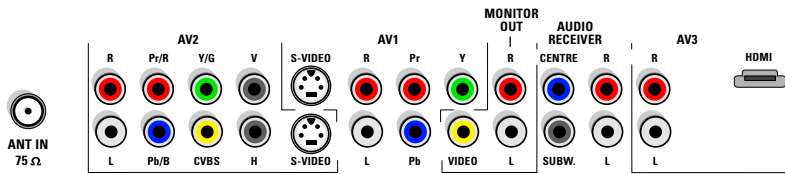

Recorder (VCR-DVD+RW)

Note: Do not place your recorder too close to the screen as some recorders may be susceptible to signals from the display. Keep a minimum distance of 0,5 m from the screen.

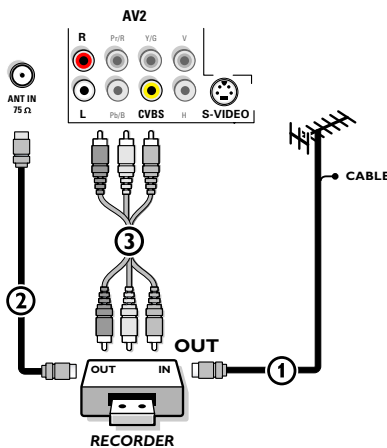

- 1 Connect the RF Antenna cable ① to the **RF IN** socket of your recorder.
- 2 Connect another RF cable ② from the output **OUT** of your recorder to the TV's input 75 Ω jack.
- 3 Better playback quality can be obtained if you also connect the Video, Audio Left and Right (only for stereo devices) AV cables ③ to the **CVBS**, **AUDIO L** and **R** input jacks of **AV2**.

If your recorder has an S-VHS video jack:

For improved picture quality, connect an S-video cable with the **S-VIDEO** input instead of connecting the recorder to the **CVBS** jack of **AV2**. S-Video does not provide audio, so audio cables must still be connected to provide sound.

Recorder and other A/V devices

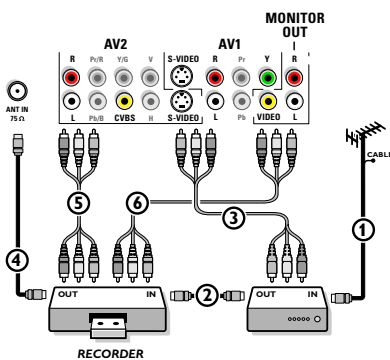

- 1 Connect the RF antenna cable ① of the **RF IN** socket of your other AV device.
- 2 Connect the RF output of the AV device to the RF input of the recorder ②.
- 3 Connect another RF cable ④ from the output **OUT** of your recorder to the TV's input 75 Ohm jack.
- 4 To obtain better picture quality, also connect the Video or S-Video, Audio left and Audio right cables of both devices to **AV1** (**Y** or **S-VIDEO**, **AUDIO L** and **R**), ③ and to **AV2** (**CVBS** or **S-VIDEO**, **AUDIO L** and **R**) ⑤.

Notes:

- In case of mono equipment, only the left loudspeaker reproduces sound. Use a mono to stereo adaptor (not supplied) for sound reproduction via all internal loudspeakers.
- When using the **S-VIDEO** connector do not connect any device to the **AV2 CVBS** or **AV1 Y** input.

The **MONITOR OUT** connector can be used for a daisy chaining or to record programmes from your TV ⑥. Only when a recorder is connected to **MONITOR OUT** it is possible to record a programme from other devices connected to the TV.
See Record with your recorder, p. 20.

DVD Player or other accessory digital source devices

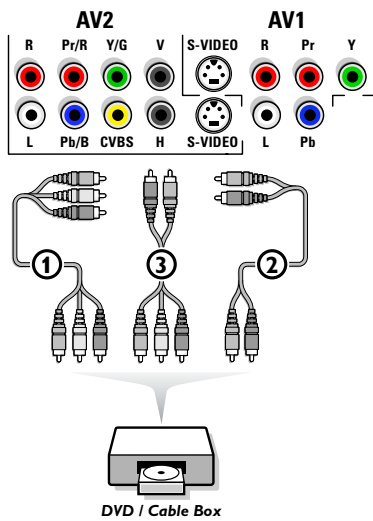

Devices with Component Video Output Connectors (YPbPr)

- 1 Connect the three separate component video cables (1) to the device having component video outputs (YPbPr), such as DVD-players, laser-disc players, videogame players, satellite receivers or other equipment, and to the Y, Pb and Pr jacks of AV1 or AV2 on the TV.
- 2 Connect the audio cable to device's AUDIO L and R (2) jacks and to the L and R audio jacks of AV1 or AV2.

Devices with RGB output

- 1 Connect the device with RGB output with separate Horizontal and Vertical sync to the Pr/R Pb/B Y/G input (1) jacks and to the H and V jacks of AV2 (3).
- 2 Connect the audio cables to the L and R AUDIO jacks of AV2.

Devices with an S-Video connector

- 1 Connect an S-Video cable to the AV1 or AV2 S-VIDEO input.
Note: When using the S-VIDEO connector do not connect any device to the AV2 CVBS or AV1 Y input.
- 2 Connect the audio cables to the device's AUDIO L and R jacks and to the L and R audio AV1 or AV2 jacks on the TV.

Notes

- The labels for the component video sockets may differ depending on the DVD player or the device connected. Although the abbreviations may vary, the letters B and R stand for the blue and red component signals, respectively, and Y indicates the luminance signal. Refer to the DVD player's or devices instructions for use for definitions and connection details.
- This television is designed to accept high definition signal standards 480p, 720p, 1080i and 1152i as specified by the Electronic Industries Association standard EIA770.3.

Digital devices from different manufacturers have the possibility of differing output standards which may cause difficulties for the television to properly display.

Warning: in case you notice scrolling images, wrong colours or no colour, no picture, or even combinations of these on your screen, check if the connections are done in the correct way or move your digital device further away from your TV.

Multi channel Surround receiver

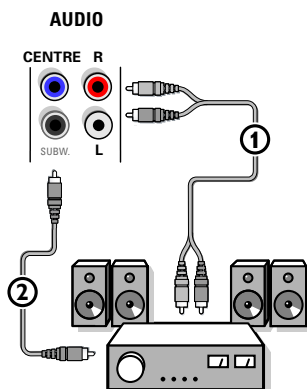

- 1 Connect the audio cable to the multi channel Surround receiver and to AUDIO RECEIVER L and R next to the CENTRE connector of your TV (1).
Note: turn off the TV and your surround receiver before connecting them. Set the Surround receiver's volume to minimum.
- 2 If you want the loudspeakers of your TV to act as centre speaker, also connect an audiocable to the multi channel Surround receiver and to the CENTRE connector of your TV (2).
- 3 Select **centre Input On** in the Source menu. See p. 9.

The loudspeakers of the TV will now only produce centre sound, the loudspeakers connected to the audio receiver will produce Surround Sound. The volume has to be controlled via the multi channel Surround receiver.

Note: No sound will be heard when a TV channel or external source is blocked via the Channel Lock menu (see p. 13).

HDMI (High Definition Multimedia Interface) connector

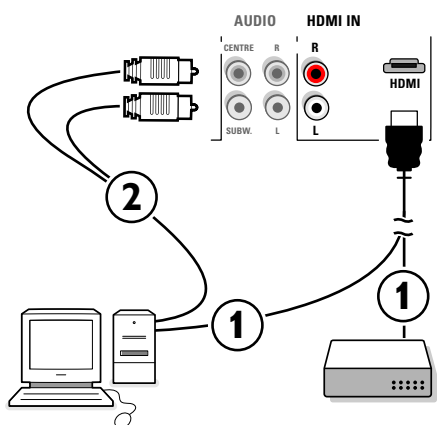

HDMI is the leading new standard for Digital High Definition video and audio interconnection. Eg. with a Digital Set top box, with HDMI-equipped devices like a PC, DVD-R, AV receiver...

Note: the HDMI connector is compatible with DVI-devices and a HDMI to DVI conversion cable is included. (Then also connect the audio cables.)

The **HDMI IN** connector allows

- the following TV and monitor display modes:

EDTV	640/720 x 480p	
	720 x 576p	
HDTV	1280 x 720p	
	1920 x 1080i	
	1152i	
VGA	640 x 480	60 Hz
SVGA	800 x 600	60 Hz

- 1 Connect the digital HDMI output of your HD device (e.g. PC, DVD player, Set Top Box..) ① to the **HDMI** connector of your TV.
- 2 In case a HD-DVI device (and if audio is present) is connected also connect the audio cable ② to the **AUDIO** outputs of your HD device and to the **R** (right) and **L** (left) **HDMI (AV3)** inputs of the panel of the TV.

Notes:

- Proper working is only guaranteed with HDMI compliant consumer products.
- Digital devices from different manufacturers have the possibility of differing output standards which may cause difficulties for the television to properly display;
- If the set is cold, there may be a small "flicker" when the set is turned on. This is normal, there is nothing wrong with the set.

Connect extra subwoofer

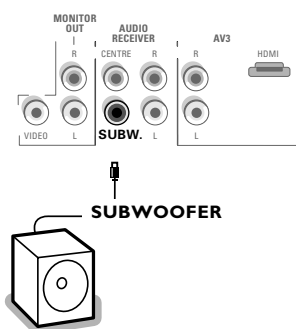

To enhance the sound reproduction of your TV you can connect an externally powered subwoofer (between 20 and 250 Hz).

- 1 Connect the audio cable of the external subwoofer to the **SUBWOOFER** socket at the bottom of your TV.
- 2 Select **Subwoofer** in the Settings, General menu, p. 7.
- 3 Adjust the frequency of the external subwoofer to 100-120 Hz (according to your personal preference) if present on the subwoofer.
- 4 Adjust the volume level of the external subwoofer, presumed this control is present on the subwoofer.
See also the instruction manual of the external subwoofer.

Side connections

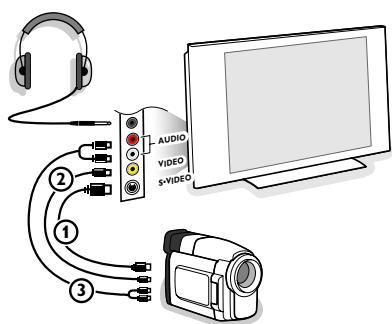

Camera, Camcorder or Game

- 1 Connect your camera, camcorder or Game as shown.
 - 2 Connect to **VIDEO** (2) and **AUDIO L** (3) for mono equipment. For stereo equipment also connect **AUDIO R** (3).
S-VHS quality with an S-VHS camcorder is obtained by connecting the S-VHS cable with the **S-VIDEO** input (1) and **AUDIO** inputs (3).
- Do not connect cable (1) and (2) at the same time. This may cause picture distortion !*

Headphone

- 1 Insert the plug into the headphone socket as shown.
- 2 Press on the remote control to switch off the internal loudspeakers of the TV.
The headphone impedance must be between 8 and 4000 Ohm. The headphone socket has a 3.5 mm jack.
In the Sound menu select **Headphone volume** to adjust the headphone volume.

To select connected peripherals

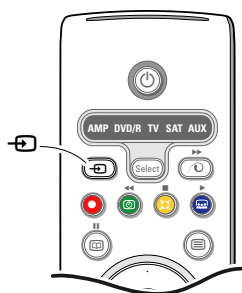

- 1 Press the key to select **AV1, AV2, HDMI (AV3), Side** or **TV** channels, according to where you connected your devices.
- 2 Press the cursor up/down.
- 3 Press **OK**.

Record with your recorder

Record a TV programme

You can record a TV programme using your recorder's tuner without affecting your TV.

- 1 Select the channel number on your recorder.
- 2 Set your recorder to record.
See the handbook for your recorder.

Switching channel numbers on your TV does not disturb recording !

Record a programme from **MONITOR OUT**

You can record a programme on your recorder from the TV tuner via **MONITOR OUT**.

- 1 Switch on the device.
- 2 Select the channel or wanted device on your TV and the correct input on your recorder.
- 3 Set your recorder to record.
You record the tuner channel of the TV or selected device.

*Do not switch channels or turn off your TV when you are recording through **MONITOR OUT**.*

Audio- and video equipment keys

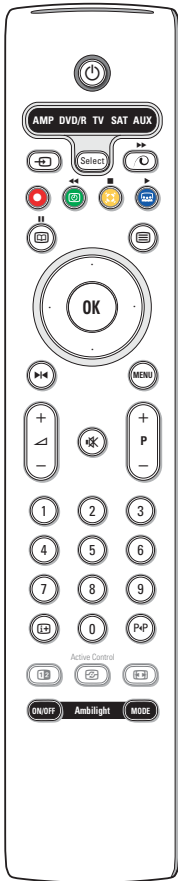

This system remote control operates the following Philips equipment: TV, VCR, DVD, DVD/R, SAT (RC5/RC6), AMP (+TUNER), CD, CD/R.

Press the **Select** key to operate any of the equipment indicated in the display (**AUX** = CD; **DVD/R** = DVD, **SAT** = SAT (RC5)). Another device can be selected by pressing **Select** repeatedly within 2 seconds. The led will blink slowly to indicate the device. Press one of the keys on the remote control to operate the peripheral equipment. To return to TV mode press **Select** while the led is blinking. When no action is taken within 60 seconds, the remote goes back to **TV** mode.

When you do not want the remote to go back to TV mode, and to stay in the mode selected, proceed as follows:

Select the desired mode with the **Select** key. Wait until no LED is lit. Press the **Select** key again simultaneously with the **OK** key for at least 2 seconds. The remote will not go back to TV mode from now on and will remain in the mode selected.

To go back to the default setting of the remote (TV mode) repeat what is explained above, selecting the TV mode.

*Note: When the **Select** key is pressed and held for more than 2 seconds, the RC5/RC6 system select command is transmitted.*

- | | | | |
|----|--|-------------------|--|
| ⏻ | to switch to standby | MENU | to switch the menu on or off |
| ⏸ | for pause (VCR, DVD, CD);
RDS news/TA (AMP);
to shuffle play (CD/R) | - P + | for chapter, channel, track selection |
| ● | for record | 0 to 9 | digit entry |
| ⏮ | for rewind (VCR, CD);
search down (DVD, AMP) | P+P | tape index (VCR),
select a DVD title/chapter,
select a frequency (AMP) |
| ■ | for stop | cursor up/down | to select the next or the previous disc (CD) |
| ▶ | for play | cursor left/right | to select the previous or following track (CD)
search up/down (AMP) |
| ⏭ | for fast forward (VCR, CD);
search up (DVD, AMP) | | |
| ⏸ | for pause (CD/R) | | |
| ☰ | RDS display (AMP);
to select your choice of subtitle language (DVD); | | |
| i+ | display information | | |

Additionally the **DVD/R**, **SAT** and **AUX** indicator can be programmed to operate the DVD-R, DVD + receiver, DVD-R + receiver, SAT (RC6), CD-R and VCR instead.

- 1 Select **TV** with the **Select** key.
- 2 To program
 - **DVD-R**, press the **OK** key + digit 2;
 - **SAT (RC6)**, press the **OK** key + digit 4;
 - **CD-R**, press the **OK** key + digit 6;
 - **DVD + receiver**, press the **OK** key + digit 7;
 - **DVD-R + receiver**, press the **OK** key + digit 8;
 - **VCR**, press the **OK** key + digit 9.
- 3 Select the corresponding **DVD/R**, **SAT**, **AUX** indicator. The remote control will operate your DVD-R, DVD or DVD-R in combination with a receiver (**DVD/R**), SAT (RC6) (**SAT**), CD-R or VCR (**AUX**).

*Note: To return to the modes programmed in the factory, either remove the batteries for a few minutes, or press the **OK** key + digit 1 (DVD mode); or + digit 3 (SAT-RC5) or + digit 5 (CD mode).*

Tips

Care of the screen	Do not touch, push or rub or strike the screen with anything hard as this may scratch, mar or damage the screen permanently. And please do not rub with dust clothes with chemical treatment. Do not touch the surface with bare hands or greasy cloth (some cosmetics are detrimental to the screen). Unplug the TV before cleaning the screen. When the surface becomes dusty, please wipe gently with absorbent cotton or other soft materials like chamois soaks. Do not use acetone, toluene and alcohol because they cause chemical damage. Do not use liquid cleaners or aerosol cleaners. Wipe off saliva or water drops as soon as possible. Their long time contact with the screen causes deformations and colour fading.
Poor Picture	<ul style="list-style-type: none"> • Have you selected the correct TV system in the manual installation menu? • Is your TV or house aerial located too close to loudspeakers, non-earthed audio equipment or neon lights, etc? • Mountains or high buildings can cause double pictures or ghost images. Sometimes you can improve the picture quality by changing the direction of the aerial. • Is the picture or teletext unrecognisable? Check if you have entered the correct frequency. See Installation, Manual installation, p. 6. • Are brightness, sharpness and contrast out of adjustment? Select Factory settings in the Setup, General menu, p. 7.
No Picture	<ul style="list-style-type: none"> • Are the supplied cables connected properly ? (The aerial cable to the TV, the other aerial to your recorder, the VGA cables to the display, the power cables.) • Has the child lock been switched off ? • Is your PC switched on ? • Do you see a black screen and the indicator in front of the TV lights up blue, this means that the display mode is not supported. Switch your HDMI-source to a correct display mode. • In case of weak or bad signal, consult your dealer.
Digital distortion	The low quality of some digital picture material may be the cause of digital image distortion. In this case select the Soft setting using the Picture menu, Smart Picture, without changing the picture settings manually.
No sound	<ul style="list-style-type: none"> • No sound on any channel? Check the volume isn't at minimum. • Is the sound interrupted with the mute key  ?
No solution found for your picture or sound problem ?	Switch your TV off and then on again once. Never attempt to repair a defective TV yourself. Check with your dealer or call a TV technician.
Remote control	<ul style="list-style-type: none"> • Check if the remote control is in the correct mode. • If your TV no longer responds to the remote control, the batteries may be dead. • You can still use the MENU key and the -/+ keys on the right side of your TV.
Standby	Your TV consumes energy in the standby mode. Energy consumption contributes to air and water pollution. Power consumption: 2 W.
No stable or not synchronised VGA picture	Check if you have selected the correct VGA mode in your PC.
Miscellaneous	See Extras, Specifications on this CD.

Warning concerning stationary images on the TV screen

A characteristic of Plasma Display Panels is that displaying the same image for a long time can cause a permanent after-image to remain on the screen. This is called phosphor burn in.

Normal use of the TV should involve the showing of pictures that contain constantly moving and changing images that fill the screen.

Examples of stationary images (this is not an all-inclusive list, you may encounter others in your viewing):

- **TV and DVD menus:** listings of DVD disk content;
- **Black bars:** when black bars appear at the left and right side of the screen, it is recommended to change to a picture format so that the picture fills the entire screen;
- **PIP and Multipip:** do not view for long periods of time using the PIP function or Multipip function;
- **TV channel logo:** present a problem if they are bright and stationary. Moving or low-contrast graphics are less likely to cause uneven aging of the screen;
- **Stock market stickers:** presented at the bottom of the TV screen;
- **Shopping channel logos and pricing displays:** bright and shown constantly or repeatedly in the same location on the TV screen.

Examples of still pictures also include logos, computer images, time display, teletext and images displayed in 4:3 mode, static images or characters, etc.

Notes:

- reduce contrast and brightness when viewing

- **once burn-in occurs it will never disappear completely.**