

Unpacking and wall mounting instructions

For the unpacking instructions follow the illustrated steps printed on the packaging (outside and inside). For the wall mounting instructions follow the illustrated steps ④ to ⑥ printed on the separate template and in the supplied booklet.

Make sure that the wall mount is being fixed securely enough so that it meets safety standards. The weight of the monitor (excl. packaging) is about 24 kg, 30 kg or 35.5 kg, depending on the screen size (32", 37" or 42").

Note: stands are optional accessories. Consult your dealer.

To prevent any unsafe situations, no naked flame sources, such as lighted candles, should be placed on or in the vicinity. Avoid heat, direct sunlight and exposure to rain or water.

The equipment shall not be exposed to dripping or splashing and no objects filled with liquids, such as vases, shall be placed on it.

English

Connect your computer

Directly to the monitor

- ① Connect one end of a VGA cable ① to the video card of the computer and the other end to the **VGA 1** connector at the rear side of the monitor. Fix the connectors firmly with the screws on the plug.
- ② In case of a Multimedia computer, connect the audio cable ② to the audio outputs of your Multimedia computer and to the **AUDIO VGA 1 R** (right) and **L** (left) inputs of the monitor.

VGA 2: The video connector for VGA 2 can be programmed to become an input or an output via the Setup menu, see p. 6. The function of being input or output is determined by the used mode. If the monitor is used in video mode, the VGA 2 connector is VGA output. If the monitor is used in monitor mode, the connector is VGA input or output.

To a electronic receiver box

See the handbook of the receiver box.

- ① Connect one end of a VGA cable to the video card of the computer and the other end to the **PC/MAC IN** connector at the rear side of the receiver box. Fix the connectors firmly with the screws on the plug.
- ② In case of a Multimedia computer, connect the audio cable to the audio outputs of your Multimedia computer and to the **AUDIO IN R** (right) and **L** (left) inputs of the receiver box.

Note: Only use the VGA cable supplied with the monitor.

Daisy chaining

The Loop Through facility makes it possible to make a daisy chain with a second monitor.

- ③ Connect one end of another VGA cable to the **VGA 2** connector at the rear side of the monitor and the other end to the **VGA 1** connector of a second monitor.
- ④ In case of a Multimedia computer, also connect audio cables to the **AUDIO L** and **R** outputs of the original monitor and to the **AUDIO L** and **R** inputs of the second monitor.

The RC out jack next to the VGA 2 connector makes it possible to daisy chain remote control signals to other equipment.

This output cannot be used to daisy chain a second monitor.

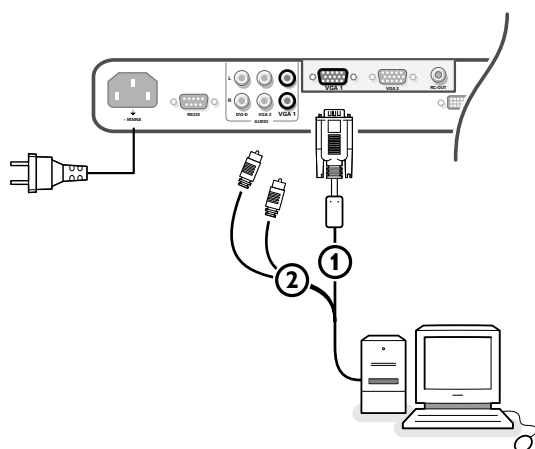

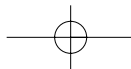

Computer Display modes

VGA	640x480	60, 72, 75, 85 Hz
Wide VGA	848x480	60 Hz
Wide VGA	852x480	60 Hz
MAC	640x480	66.67 Hz
MAC	832x624	74.55 Hz
MAC	1024x768	74.93 Hz
MAC	1152x870	75 Hz
SVGA	800x600	56, 60, 72, 75, 85 Hz
XGA	1024x768	60, 70, 75, 85 Hz
SXGA	1280x1024	60 Hz, 72 Hz (not with DVI-D source)

When a VGA computer is connected, the display selection is made automatically.

A message is displayed when the monitor does not support the connected VGA mode. Switch your computer to a correct display mode.

Operation

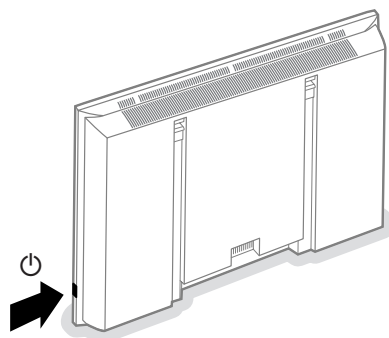
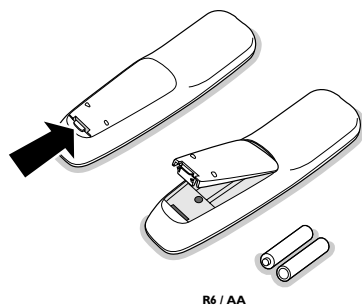

1 Insert the mains plug supplied into the mains inlet at the back of the monitor and in the wall socket. For safety, please, only use the supplied rim-earthed mains cord which has to be inserted in a grounded socket.

2 Remote control: remove the cover of the battery compartment. Insert the 2 batteries supplied (Type LR6/AA-1.5V).

The batteries supplied do not contain the heavy metals mercury and cadmium. Nevertheless in many countries batteries may not be disposed of with your household waste. Please check on how to dispose of batteries according to local regulations.

3 Make sure that your receiver box and/or PC are switched on and that your PC is in the correct display mode.

4 Switch the monitor on : Press the power key  at the right side of the monitor.

A green indicator lights up and the screen comes on.

When the monitor does not receive a supported VGA signal and is not connected to a receiver box, the screen switches to standby and the red indicator lights up.

When you switch on your monitor **for the first time**, and the monitor is not connected to an electronic receiver box, the language menu automatically appears on the screen. The explanation appears in different languages one at a time.

Follow the instructions on screen to select the correct language or see Setup menu, Language, p. 6.

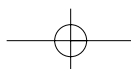

Use of the remote control

VGA

press repeatedly to select your computer connected to the **VGA 1** or **2** connector or to the **DVI-D** connector.

AV1, AV2, AV3

press to select the peripherals connected to the connector indicated on the monitor.

Note: in case the monitor is operating in combination with an electronic receiver box, the AV inputs on the monitor will be disabled and the VGA2 connector becomes an output.

BRIGHTNESS +/-

to adjust the brightness level of the picture

CONTRAST +/-

to adjust the contrast level of the picture

ZOOM ON/OFF

to activate/de-activate the zoom function. See p. 5.

ZOOM IN/OUT to adjust the zoom factor and to change the magnification of the picture when zoom is activated. See p. 5.

 to switch to standby or on again

MENU to switch the menu on/off
cursor buttons to select your choice and to alter a selected adjustment.

OK to activate your choice

 press - or + to adjust the volume

Mute button

Mute the sound or restore it

CH/PR Program selection

To browse through the sources selected.

AV MUTE to mute the picture and the sound or restore it (if the monitor is used in monitor mode).

When activated a green indicator starts blinking in front of the monitor.

Picture format

See Picture 2 menu, p. 5.

Press the  button to switch between the different picture formats.

On screen information

When the monitor is used in the monitor mode, information about the active source (**AV1, AV2, AV3, VGA1, VGA2** or **DVI-D**), and the supported video, VGA or HD-format of the selected source is displayed on the screen together with the selected picture format and icons informing about selected sound mode and AV or audio mute.

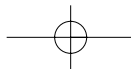

Use of the menus and the menu system

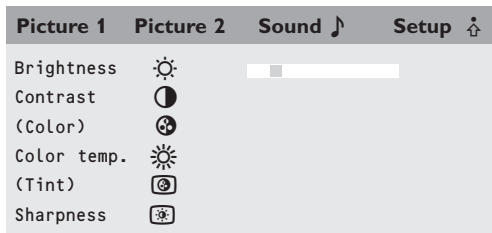

- 1 Press the **MENU** button on the remote control to summon the different menu headers.
- 2 Press the cursor left/right to move the cursor horizontally through the menu headers.
- 3 Press the cursor down to access the menu.
In case of a slider, move the cursor left/right to adjust.
In case of a list with options, move the cursor right to enter and use the cursor up/down to select an option.
Press the cursor left to leave the options list.
- 4 Press the **MENU** button again to switch off the menu.

*Note: Sometimes not all the menu items are visible on the screen.
Press the cursor down until all the items are displayed.*

Only when the US English language has been selected (see Setup menu, Language, p. 6), the menu items will be displayed with additional icons.

Operation

Press the **MENU** button on the remote control to summon the main menu.

Picture 1 menu

Brightness

This control allows you to adjust the brightness level of the picture.

Contrast

This control allows you to adjust the contrast level of the picture.

Color (only available when the source is AV1, AV2 or AV3 YCbCr)

This control allows you to adjust the saturation level of the colors to suit your personal preference.

Color temperature

This control allows you to select the color temperature of the picture.
Move the cursor up/down to make a selection.
Press the cursor left to return to the Picture 1 menu.

Tint (only with NTSC signals and when the source is AV1 or AV2)

This control allows you to compensate for the color variations in NTSC encoded transmissions.

Sharpness

This control allows you to adjust the edge definition of a picture.

SD video-mode

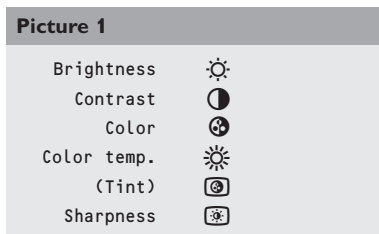

VGA-mode + HD video mode

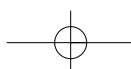
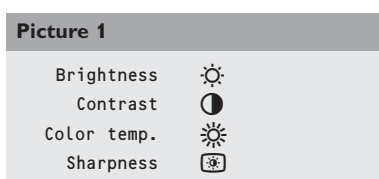

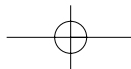

SD video-mode

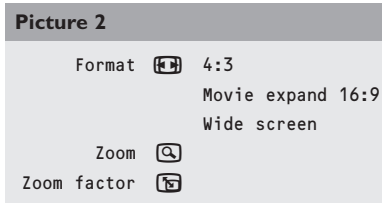

VGA-mode + HD video mode

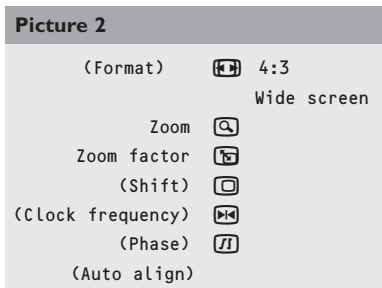

4:3 VGA-mode

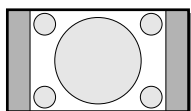

4:3

SD video-mode

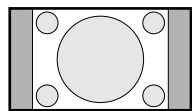

4:3

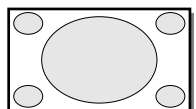

Wide screen

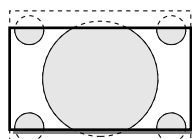

Movie expand 16:9

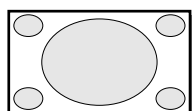

Wide screen

Picture 2 menu

Zoom

Select **Zoom On** to activate the zoom function.

You may also activate the zoom function with the **ZOOM ON/OFF** button on the remote control.

If no zoom is active, press the cursor left/right, up/down to select which part of the screen will be zoomed.

Zoom factor

Select **Zoom factor** and press the cursor left/right to adjust the zoom factor and to change the magnification of the picture.

If zoom is not active, changing the magnification factor will have no effect on the displayed picture.

Format (only available in 4:3 VGA mode and SD video mode)

Select **Format** to summon a list of **available** display formats.

Press the cursor up/down to select another display format: 4:3, **Movie expand 16:9** or **Wide screen**.

Note: *Movie expand 16:9 is not available in VGA mode.*

Shift (only available in VGA mode on VGA1 or VGA2 and in one of the HD modes. See *Connect Peripheral Equipment*, p. 7.)

This control allows you, when necessary, to move the picture in a horizontal or vertical way.

- 1 Use the cursor left/right, up/down to adjust.
- 2 Press the **OK** button when done.

Clock frequency (only available in VGA mode on VGA 1 or VGA 2.

See *Connect Peripheral equipment*, p. 7.)

This control allows you, when necessary, to adjust the values of the clock frequency so that especially text can be displayed with an optimal overall sharpness.

Use the cursor left/right to adjust.

Phase (only available in VGA mode on VGA 1 or VGA 2.

See *Connect Peripheral equipment*, p. 7.)

This control allows you, when necessary, to adjust the pixel phase of the picture to avoid picture interference.

Use the cursor left/right to adjust.

Auto align (only available in VGA mode on VGA1 or VGA2 and in one of the HD modes. See *Connect Peripheral Equipment*, p. 7.)

This control allows you to automatically adjust the shift, the clock frequency and the phase in VGA mode and the shift in HD modes.

Press **OK** to execute.

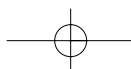

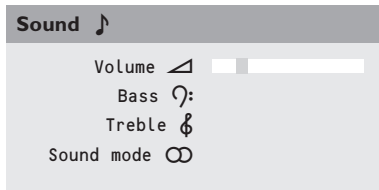
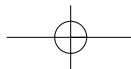

Sound menu

Volume

This control allows you to adjust the volume level of the sound from the speakers.

Bass

Bass attenuates or amplifies the low-frequency response of the sound from the loudspeakers.

Treble

Treble attenuates or amplifies the high-frequency response of the sound from the loudspeakers.

Sound mode

This control allows you to switch between mono and stereo sound.

Note: Bass, Treble and Sound mode will not be available in VGA loop through mode, i.e. when an electronic receiver box is connected to the monitor and a VGA source is selected.

Setup menu

Language

- 1 Use the cursor down to select **Language**.
- 2 Press the cursor right to enter the list of selectable languages.
- 3 Use the cursor up/down to scroll through the list and to bring up other languages which are not displayed on the screen at present.

Note: Only with the US English language, the menu items will be displayed with additional icons.

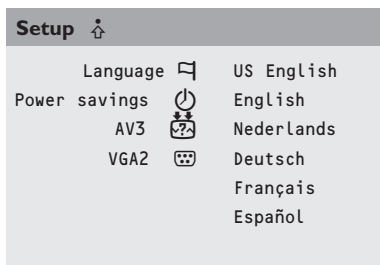

Power savings

This control allows you to overrule the automatic power savings feature. In case **Power savings** is switched **Off**, the power always remains on until the monitor is forced to standby.

- 1 Use the cursor down to select **Power savings**.
- 2 Press the cursor left/right to select **On** or **Off**.

AV3

This control allows you to set the AV3 input to HD-RGB, YCbCr or HD-YPbPr. When having selected **Auto**, the monitor makes the selection automatically between YCbCr, HD-YPbPr or HD-RGB.

See also p. 7, Equipment with Component Video Output connectors.

- 1 Use the cursor down to select **AV3**.
- 2 Press the cursor right to enter the list with options.
- 3 Press the cursor up/down to select one of the options.

VGA2

This control allows you to select whether to set the VGA2 connector as input, output or even HD-input.

- 1 Use the cursor down to select **VGA2**.
- 2 Press the cursor right to enter the list with options: **VGA IN**, **VGA OUT** or **HD IN**.
- 3 Press the cursor up/down to select one of the options.

Note: AV3 and VGA2 will not be available in VGA loop through mode, i.e. when a receiver box is connected to the monitor and a VGA source is selected.

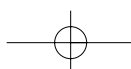

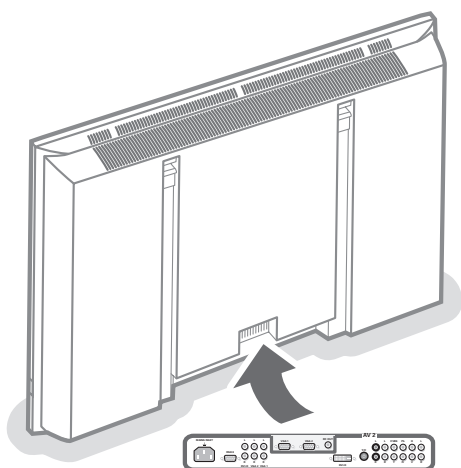

Connect Peripheral Equipment

You may connect 3 possible VGA sources (**VGA1**, **VGA2** or **DVI-D**) and 3 possible video sources (**AV1**, **AV2** and **AV3**) to the monitor.

The following diagrams show you where you can connect your peripheral equipment.

Note: in case the monitor is operating in combination with an electronic receiver box, the AV inputs on the monitor will be disabled and the VGA2 connector becomes an output.

Equipment with Y/C-SVHS output connectors

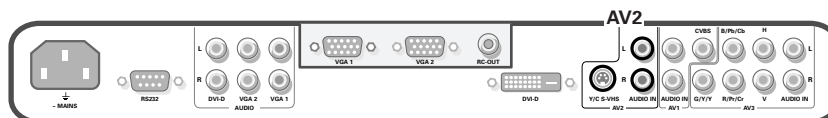

- 1 Connect the video cable to the **AV2** connector.
- 2 Connect the audio cables to the equipment's **AUDIO L** and **R** sockets and to the **AUDIO L** and **AUDIO RA2** sockets on the monitor.

Equipment with CVBS output connectors

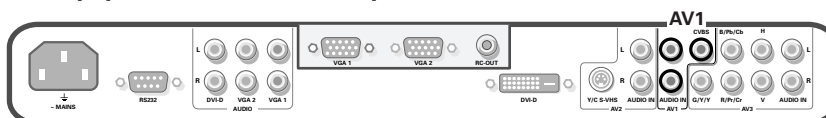

- 1 Connect the video cable to the **AV1** connector.
- 2 Connect the audio cables to the equipment's **AUDIO L** and **R** sockets and to the **AUDIO L** and **RAV1** sockets on the monitor.

Equipment with Component Video Output connectors

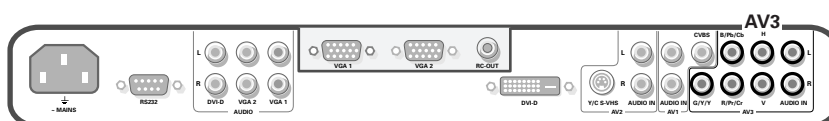

Note: AV3 can handle the following video signals: YCbCr, HD-YpPr and HD-RGB. The discrimination between the various input formats and the appropriate video processing is done automatically. It is however possible to overrule the automatic detection. See Setup menu, p. 6.

- 1 Connect the video cables of your equipment with YPbPr output with composite sync on Y, or of your equipment with YCbCr output with composite sync on Y to the YPbPr, resp. YCbCr input **AV3 IN** sockets of the monitor.
- 2 Connect the video cables of your equipment with RGB output with separate Horizontal and Vertical sync to the RGB input sockets and to the H and V sockets **AV3** of the monitor.
- 3 Connect the audio cables to the equipment's **AUDIO L** and **R** sockets and to the **AUDIO IN L** and **AUDIO IN RA3** sockets on the monitor.

Note: when High Definition signals are inputted to the monitor via the YCbCr/RGB input, the monitor switches to the HD Video Mode.

The following HD and ED video modes are supported by the monitor on the YCbCr, RGB and VGA2 HD input:

1920x1080/60I 720x480/60P
1280x720/60P 720x576/50P

The following SD video modes are supported by the monitor on the YPbPr input:

720x480/60I
720x576/50I

Note: you should make the correct selection for AV3 in the Setup menu, p. 6.

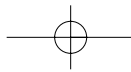

High Definition equipment with VGA connector

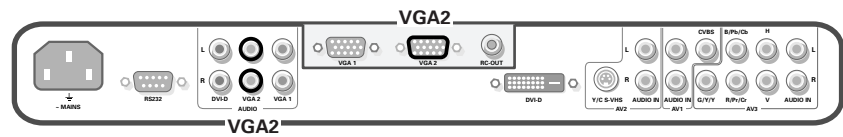

- 1 Connect the VGA output of your equipment to the **VGA2** connector.
- 2 Connect the audio cables to the equipment's **AUDIO L** and **R** sockets and to the **VGA2 AUDIO L** and **R** sockets on the monitor.
*Note: you should select **HD IN** for **VGA2** in the Setup menu. (See p. 6.)*

Digital DVI output of your PC (DVI-D) or DVD player

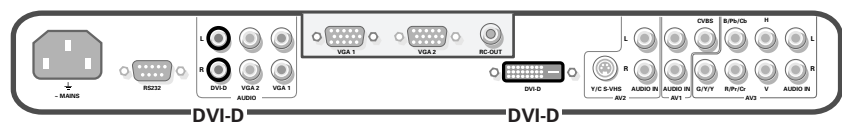

- 1 Connect the Digital DVI output of your PC or DVD-player to the **DVI-D** connector.
- 2 Connect the audio cables to the **DVI-D AUDIO L** and **R** sockets on the monitor.

RC out connector

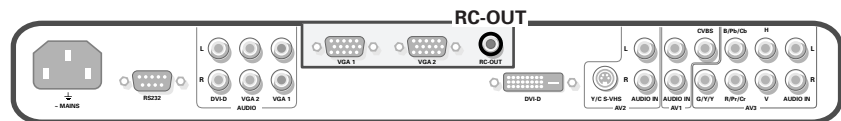

This connector allows you to daisy chain remote control signals to other equipment (e.g. AV receiver, IR repeater) which have an electrical RC in.

Note: it is not possible to daisy chain a second monitor.

Serial I/O port RS232

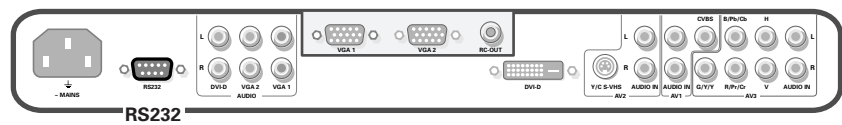

The RS232 connector is only to be used with the monitor as stand alone. This connector allows you to control the monitor via your PC (as a replacement of the remote control).

Note: This connector can also be used for dealer service tools.

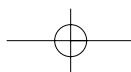

Tips

Ambient temperature

Do not hang up the monitor above a central heating or other heating sources.

Care of the screen

Clean the anti-reflex coated flat glass screen with a slightly damp soft cloth. Do not use abrasives solvents as it can damage the glass surface of the screen.

Plasma Display characteristics

Caution: A video source (such as a video game, DVD, or video information channel) which shows a constant non-moving pattern on the monitor screen, can cause damage to the screen. When your Flat-Monitor is continuously used with such a source, the pattern of the non-moving portion of the game (DVD, etc.) could leave an image permanently on the screen. When not in use, turn the video source **OFF**. Regularly alternate the use of such video sources with normal viewing.

When switching over to another picture after having displayed the same still picture for a long time (many hours), it may happen that some parts from the previous picture will remain on screen due to a kind of memory effect. This ghost picture will disappear after some time. To avoid this effect change the pictures regularly or for PC use you can turn on a screen saver in your computer.

Philips has built in an automatic shift of the picture in video mode every 5 minutes to decrease this effect and to prolong the life of the screen.

Very incidentally and after a longer period of unuse (approx. 1 year) the screen may display some strange colour deficiencies. This is quite normal for plasma displays and these effects will disappear after the set has been turned on for some time.

A plasma display consists of a high number of colour pixels. It is within industry standards that very few pixels (< 0.001%) may be defective, even for a new set.

There is however no reason to doubt about the quality of the set.

The plasma display technology operates with rare gases which are being influenced by air pressure.

Up to an altitude of 6562 ft (local air pressure equal or above 800 hPa) above sea-level, the display is functioning fine. Operating the set at a higher altitude (lower air pressure), the picture becomes unstable and the picture performance is deteriorating. The plasma display might then also produce a humming sound. After bringing the set below 6562 ft (local air pressure equal or above 800 hPa) it works fine again. Transportation has no influence.

Control of peripheral equipment

The infrared radiation of the screen may influence the reception sensitivity of other peripherals. Solution: replace the batteries of the remote control or change position of other equipment. E.g. keep away a wireless headphone from within a radius of 4.92 ft.

No stable or not synchronized VGA picture

Check if you have selected the correct display mode in your PC. See p.4, Computer display modes.

No picture or no sound

Are the supplied cables connected properly? (The power cable to the display, the VGA cables, the audio cables,...)

Is your PC switched on?

Do you see a black screen and the indicator in front of the monitor lights up green, this means that the display mode is not supported.

Switch your VGA source to a correct mode.

Remote control

If your monitor no longer responds to the remote control, the batteries may be exhausted.

If your problem is not solved:

Switch your monitor off and then on again.

Never attempt to repair a defective monitor yourself.

Check with your dealer or call a video technician.

Transport

Keep the original packaging to transport the monitor if needed.

End of life directives

Philips is paying a lot of attention to produce environmentally-friendly in green focal areas. Your new monitor contains materials which can be recycled and reused.

At the end of its life specialized companies can dismantle the discarded monitor to concentrate the reusable materials and to minimize the amount of materials to be disposed of.

Please ensure you dispose of your old monitor according to local regulations.

How to dispose of batteries ?

The batteries supplied do not contain the heavy metals mercury and cadmium. Nevertheless in many countries batteries may not be disposed of with your household waste. Please ensure you dispose of batteries according to local regulations.

Miscellaneous

- . Ambient temperature: + 5 ~ + 40°C
- . Maximum operating altitude: 2000 m/6562 ft (min. air pressure 800h Pa)
- . Mains: AC 110-240V 50/60 Hz
- . Power consumption:
 - 32": 170 W,
 - 37": 215 W,
 - 42": 315 W (42FD9953/69S) or 365 W (42FD9954/69S)
- . Standby consumption: < 2 W
- . Weight (excl. packaging)
 - Display: 24 kg (32"), 30 kg (37") or 35.5 kg (42")
- . Dimensions (wxhxd):
 - Display: 96.4 x 51.2 x 9 cm (32"), 106 x 58 x 9 cm (37") or 121 x 66 x 9 cm (42")
- . Wall mounting bracket included

