

SAFETY AND  
TROUBLESHOOTING

ABOUT  
THIS MANUAL

PRODUCT  
INFORMATION

INSTALLING  
YOUR MONITOR

ON-SCREEN  
DISPLAY

REMOTE CONTROL

CUSTOMER CARE  
AND WARRANTY

DOWNLOAD  
AND PRINT

EXIT 



LCD Monitor/ TV

**BDL3221V**



# Safety and Troubleshooting Information

[Safety Precautions and Maintenance](#) • [FAQs](#) • [Troubleshooting](#) • [Regulatory Information](#) • [Other Related Information](#)

---

## Safety precautions and maintenance



**WARNING: Use of controls, adjustments or procedures other than those specified in this documentation may result in exposure to shock, electrical hazards and/or mechanical hazards.**

Read and follow these instructions when connecting and using your computer monitor:

### Operation:

- Keep the monitor out of direct sunlight and away from stoves or any other heat source.
- Remove any object that could fall into ventilation holes or prevent proper cooling of the monitor's electronics.
- Do not block the ventilation holes on the cabinet.
- When positioning the monitor, make sure the power plug and outlet are easily accessible.
- If turning off the monitor by detaching the power cable or DC power cord, wait for 6 seconds before attaching the power cable or DC power cord for normal operation.
- Please use approved power cord provided by Philips all the time. If your power cord is missing, please contact with your local service center. (Please refer to Customer Care Consumer Information Center)
- Do not subject the LCD monitor to severe vibration or high impact conditions during operation.
- Do not knock or drop the monitor during operation or transportation.

### Maintenance:

- To protect your display from possible damage, do not put excessive pressure on the LCD panel. When moving your monitor, grasp the frame to lift; do not lift the monitor by placing your hand or fingers on the LCD panel.
- Unplug the monitor if you are not going to use it for an extensive period of time.
- Unplug the monitor if you need to clean it with a slightly damp cloth. The screen may be wiped with a dry cloth when the power is off. However, never use organic solvent, such as, alcohol, or ammonia-based liquids to clean your monitor.

- To avoid the risk of shock or permanent damage to the set, do not expose the monitor to dust, rain, water, or excessive moisture environment.
- If your monitor gets wet, wipe it with dry cloth as soon as possible.
- If foreign substance or water gets in your monitor, please turn the power off immediately and disconnect the power cord. Then, remove the foreign substance or water, and send it to the maintenance center.
- Do not store or use the LCD monitor in locations exposed to heat, direct sunlight or extreme cold.
- In order to maintain the best performance of your monitor and use it for a longer lifetime, please use the monitor in a location that falls within the following temperature and humidity ranges.
  - Temperature: 5-40°C 41-104°F
  - Humidity: 20-80% RH

### Service:

- The casing cover should be opened only by qualified service personnel.
- If there is any need for any document for repair or integration, please contact with your local service center. (please refer to the chapter of "Consumer Information Center")
- For transportation information, please refer to "Physical Specifications".
- Do not leave your monitor in a car/trunk under direct sun light.



Consult a service technician if the monitor does not operate normally, or you are not sure what procedure to take when the operating instructions given in this manual have been followed.

[RETURN TO TOP OF THE PAGE](#)

# About This Manual

[About This Guide](#) • [Notational Descriptions](#)

---

## About This Guide

This electronic user's guide is intended for anyone who uses the Philips LCD Monitor TV. It describes the features, setup, operation and other important information.

It includes the following sections:

- [Safety and Troubleshooting Information](#) provides tips and solutions for common problems as well as other related information you may need.
- About This Electronic User's Manual gives an overview of information included, along with notation icon descriptions and other documentation for your reference.
- [Product Information](#) gives an overview of the monitor's features as well as the technical specifications for this monitor.
- [Installing Your Monitor](#) describes the initial setup process and gives an overview of how to use the monitor.
- [On-Screen Display](#) provides information on adjusting the settings on your monitor.
- [Remote Control](#) provides information on adjusting the settings for your TV function.
- [Customer Care and Warranty](#) contains a list of worldwide Philips Consumer Information Centres along with help desk phone numbers and information on the warranty applicable to your product.
- [Download and Print Option](#) transfers this entire manual to your hard drive for easy reference.

[RETURN TO TOP OF THE PAGE](#)

---

## Notational Descriptions

The following subsections describe notational conventions used in this document.

## Notes, Cautions and Warnings

Throughout this guide blocks of text may be accompanied by an icon and printed in bold or italic type. These blocks contain notes, cautions or warnings. They are used as follows:



**NOTE:** This icon indicates important information and tips that help you make better use of your computer system.



**CAUTION:** This icon indicates information that tells you how to avoid either potential damage to hardware or loss of data.



**WARNING:** This icon indicates the potential for bodily harm and tells you how to avoid the problem.

Some warnings may appear in alternate formats and may not be accompanied by an icon. In such cases, the specific presentation of the warning is mandated by the relevant regulatory authority.

[RETURN TO TOP OF THE PAGE](#)

---

©2005 Koninklijke Philips Electronics N.V.

All rights reserved. Reproduction, copying, use, modification, hiring, renting, public performance, transmission and/or broadcasting in whole or in part is prohibited without written consent of Philips Electronics N.V.

## Product Information

[Product Features](#) • [Technical Specifications](#) • [Resolution & Preset Modes](#) • [Philips Pixel Defect Policy](#) • [Automatic Power Saving](#) • [Physical Specification](#) • [Pin Assignment](#) • [Product Views](#)

---

### Product Features

#### **BDL3221V**

- **Less management effort for maximum productivity**
  - Multiple displays form a daisy chain to show uniform
  - Monitor is network controllable for remote management
  - Input connectors: CVBS, S-video, SCART, YPbPr, and RF (TV input)
- **Better front of screen experience**
  - Motion adaptive deinterlacing for razor sharp images
  - 3D comb filter separates color for a razor-sharp image
  - WXGA, wide format 1366 x 768 resolution for sharper display
  - Adaptive brightness intensifier technology
  - Ready to display SDTV, EDTV, and HDTV formats
- **Great convenience**
  - Zoom function to enable tiled matrix application
  - Support high-bandwidth digital content protection decryption
  - Split screen for dual video/PC display
  - Picture in picture for public display

\* *RF(TV input) is only available for 320WN6QS*

[RETURN TO TOP OF THE PAGE](#)

---

### Technical Specifications\*

<b>LCD PANEL</b>
------------------

• Type	TFT LCD
• Screen size	31.51inch
• Pixel Pitch	0.17 x 0.511 mm
• LCD Panel type	1366 x 768 pixels R.G.B. vertical stripe Hard coating surface, anti-glare polarizer
• Effective viewing area	697.7 x 392.2 mm
• Display Colors	8 bits interface (16.7M colors)

## PC SCANNING

• Vertical refresh rate	56Hz-75Hz
• Horizontal frequency	30kHz-63kHz

## PC VIDEO

• Video dot rate	< 85 MHz
• Input impedance	
- Video	75 ohm
- Sync	2.2K ohm
• Input signal levels	0.7 Vpp
• Sync input signal	Separate sync
• Sync polarities	Positive and negative
• Input Frequency	WXGA Hsync 48 kHz, Vsync 60 Hz (N.I.) SVGA Hsync 38 kHz, Vsync 60 Hz (N.I.) VGA/DVI-D Hsync 31 kHz, Vsync 60 Hz (N.I.)
• Video interface	D-sub, S-Video, TV-RF, SCART composite, components video, and DVI

## AUDIO

• Input level for PC/SVHS/SCART	500 mV nominal
• Loudspeaker	10W Stereo Audio (10W/channel RMS x2, 200Hz~10kHz, 8 ohm, 10% THD)

## OPTICAL CHARACTERISTICS

• Contrast ratio	1200:1(with DCR on)
• Brightness	500 cd/m <sup>2</sup> (typ.)
• Peak contrast angle	6 o'clock
• White Chromaticity	x: 0.283 y: 0.297 (at 9300°K) x: 0.313 y: 0.329 (at 6500°K) x: 0.328 y: 0.344 (at 5700°K)
• Viewing Angle (C/R >5)	Upper ≥89° (typ.) Lower ≥89° (typ.) Left ≥89° (typ.) Right ≥89° (typ.)
• Response time	(G to G) 8ms(typ.) 12ms(max.)

## sRGB

sRGB is a standard for ensuring correct exchange of colors between different devices (e.g. digital cameras, monitors, printers, scanners, etc.)

Using a standard unified color space, sRGB will help represent pictures taken by an sRGB compatible device correctly on your sRGB enabled Philips monitors. In that way, the colors are calibrated and you can rely on the correctness of the colors shown on your screen.

Important with the use of sRGB is that the brightness and contrast of your monitor is fixed to a predefined setting as well as the color gamut. Therefore it is important to select the sRGB setting in the monitor's OSD.

To do so, at PC mode, open the OSD by pressing the MENU button of your monitor. Use the down button to go to COLOR SETTINGS and press MENU again. Then move the down button to go to NORMAL COLOR and press MENU again.

*\* This data is subject to change without notice.*

[RETURN TO TOP OF THE PAGE](#)



## Resolution & Preset Modes

- Recommended 1366 x 768 at 60Hz

### 10 factory preset modes:

Resolution	Mode	H. freq (kHz)	V. freq (Hz)
<b>PC</b>			
640x350	VGA-1	31.469	70.086
640x480	VGA VESA 60	31.469	59.940
640x480	VGA VESA 75	37.500	75.000
720x400	IBM VGA 3H	31.468	70.087
800x600	SVGA VESA 56	35.156	56.250
800x600	SVGA VESA 60	37.879	60.317
800x600	SVGA VESA 75	46.875	75.000
1280x1024	XGA VESA 60	48.363	60.004
1280x1024	XGA VESA 75	60.023	75.029
1280x768	GTF 60	47.700	60.000
1280x768	Wincomm	45.113	56.260
1360x768	VESA	47.700	60.000

### Video

720x480	480i	15.734	59.940
720x576	576i	15.625	50.000
720x480	480p	31.470	60.000
720x576	576p	31.250	50.000
1280x720	720p	28.200	50.000
1280x720	720p	33.750	60.000
1920x1080	1080i	37.500	50.000
1920x1080	1080i	45.000	60.000

[RETURN TO TOP OF THE PAGE](#)

## Automatic Power Saving

If you have VESA DPMS compliance display card or software installed in your PC, the monitor can automatically reduce its power consumption when not in use. If an input from a keyboard, mouse or other input device is detected, the monitor will then 'wake up' automatically. The following table shows the power consumption and signaling of this automatic power saving feature:

Power Management Definition					
VESA Mode	Video	H-sync	V-sync	Power Used	LED color
Active	On	Yes	Yes	100 W (typ.)	Blue
Sleep	Off	No	No	< 5 W	Amber
Switch Off	Off	-	-	< 3 W	Off

[RETURN TO TOP OF THE PAGE](#)

## Physical Specifications

• Dimension (WxHxD) *	1014mm x 517mm x 244mm (incl. Pedestal, Speakers) 794mm x 490mm x 130mm (w/o Pedestal, Speakers)
• Weight	19.2 kg (incl. Pedestal, Speakers)
• Power supply	100 — 240 VAC, 60 — 50 Hz
• Power consumption	PC Mode: 100 W (typ.) TV Mode: 130 W (typ.)
• Temperature (operating)	5° C to 35° C
• Relative humidity	20% to 80%

• System MTBF	50K hrs (excluding CCFL 40Khrs)
---------------	---------------------------------

\* This data is subject to change without notice.

[RETURN TO TOP OF THE PAGE](#)

## Pin Assignment

1. The digital only connector (DVI-D) contains 24 signal contacts organized in three rows of eight contacts. Signal pin assignments are listed in the following table:

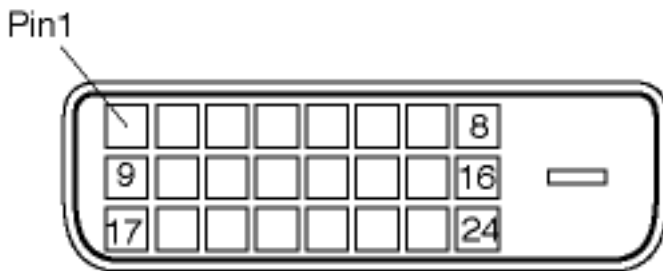

Pin No.	Signal Assignment	Pin No.	Signal Assignment	Pin No.	Signal Assignment
1	T.M.D.S. Data2-	9	T.M.D.S. Data1-	17	T.M.D.S. Data0-
2	T.M.D.S. Data2+	10	T.M.D.S. Data1+	18	T.M.D.S. Data0+
3	T.M.D.S. Data2/4 Shield	11	T.M.D.S. Data1/3 Shield	19	T.M.D.S. Data0/5 Shield
4	No connect	12	No connect	20	No connect
5	No connect	13	No connect	21	No connect
6	DDC Clock	14	+5V Power	22	T.M.D.S. Clock Shield
7	DDC Data	15	Hot Plug Detect	23	T.M.D.S. Clock+
8	No connect	16	Ground (for +5V)	24	T.M.D.S. Clock-

2. The 15-pin D-sub connector (male) of the signal cable:

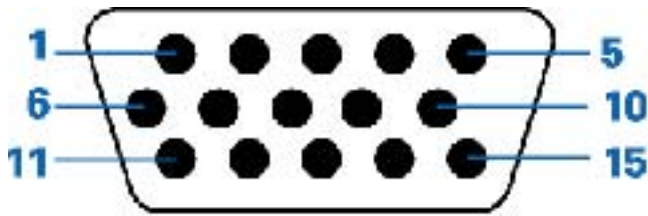

Pin No.	Assignment	Pin No.	Assignment
1	Red video input	9	DDC +5V
2	Green video input	10	Cable detect
3	Blue video input	11	Identical output, connected to pin 10
4	Ground	12	Serial data line (SDA)
5	NC	13	H. Sync / H+V
6	Red video ground	14	V. Sync
7	Green video ground	15	Data clock line (SCL)
8	Blue video ground		

### 3. RS232 Connector

D-sub 9-pin male connector for communication with plasma engine or PC.

#### RS232 DB9 (EIA/TIA 574)



(view into male end)

Pin No.	RS-232 (EIA-232-A) Function
3	Transmit Data (TD) from DTE to DCE
2	Receive Data (RD) from DCE to DTE
7	Request to Send (RTS)
8	Clear to Send (CTS)
6	DCE Ready (DSR)

5	Signal Ground (SG)
1	Received Line Signal Detector (DCD)
4	DTE Ready (DTR)
9	Ring Indicator

#### 4. SCART Connector

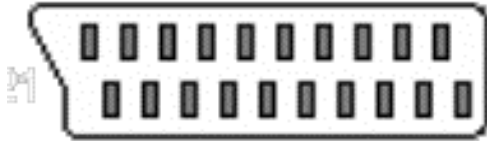

Pin No.	Signal	Pin No.
1	Audio right channel output (0.5 Vrms, < 1K ohms)	2
2	Audio right channel input (0.5 Vrms, > 10K ohms)	1
3	Audio left channel output (0.5 Vrms, < 1K ohms)	6
4	Audio ground	4
5	Blue signal ground	5
6	Audio left channel input (0.5 Vrms, > 10K ohms)	3
7	Blue signal I/O (0.7 Vp-p, 75 ohms)	7
8	Function switching I/O (L: < 2V, H: > 10V, 10K ohms)	8
9	Green signal ground	9
10	Intercommunication data line No. 1	10
11	Green signal I/O (0.7 Vp-p, 75 ohms)	11
12	Intercommunication data line No. 2	12

13	Red signal ground	13
14	Blanking signal ground	14
15	Red signal I/O (0.7 Vp-p, 75 ohms)	15
16	Blanking signal I/O (L: < 0.4V, H: >1.0V, 75 ohms)	16
17	Composite video signal ground	18
18	Blanking signal ground	17
19	Composite video signal output (1 Vp-p, 75 ohms, sync: negative)	20
20	Composite video signal input (1 Vp-p, 75 ohms, sync: negative)	19
21	Plug shield (common ground)	21

[RETURN TO TOP OF THE PAGE](#)

---

## Product Views

Follow the links to see various views of the monitor and its components.

## Product Description

[RETURN TO TOP OF THE PAGE](#)

# Installing your LCD Monitor/TV

Product Description • Connecting to Your PC, TV antenna, DVD/VCR etc. • Getting Started • Optimizing Performance

---

## Product Description

### Installing your LCD Monitor/TV

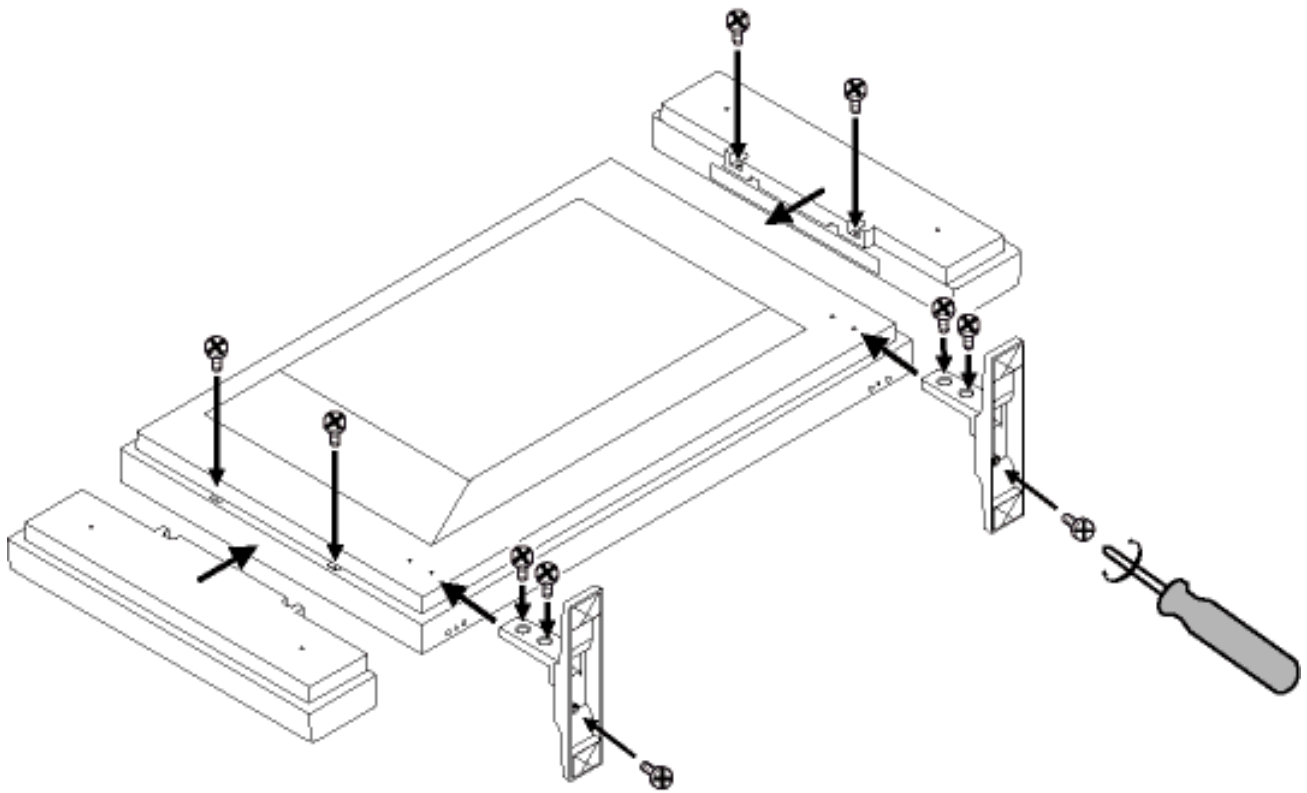

### Side View (Left)

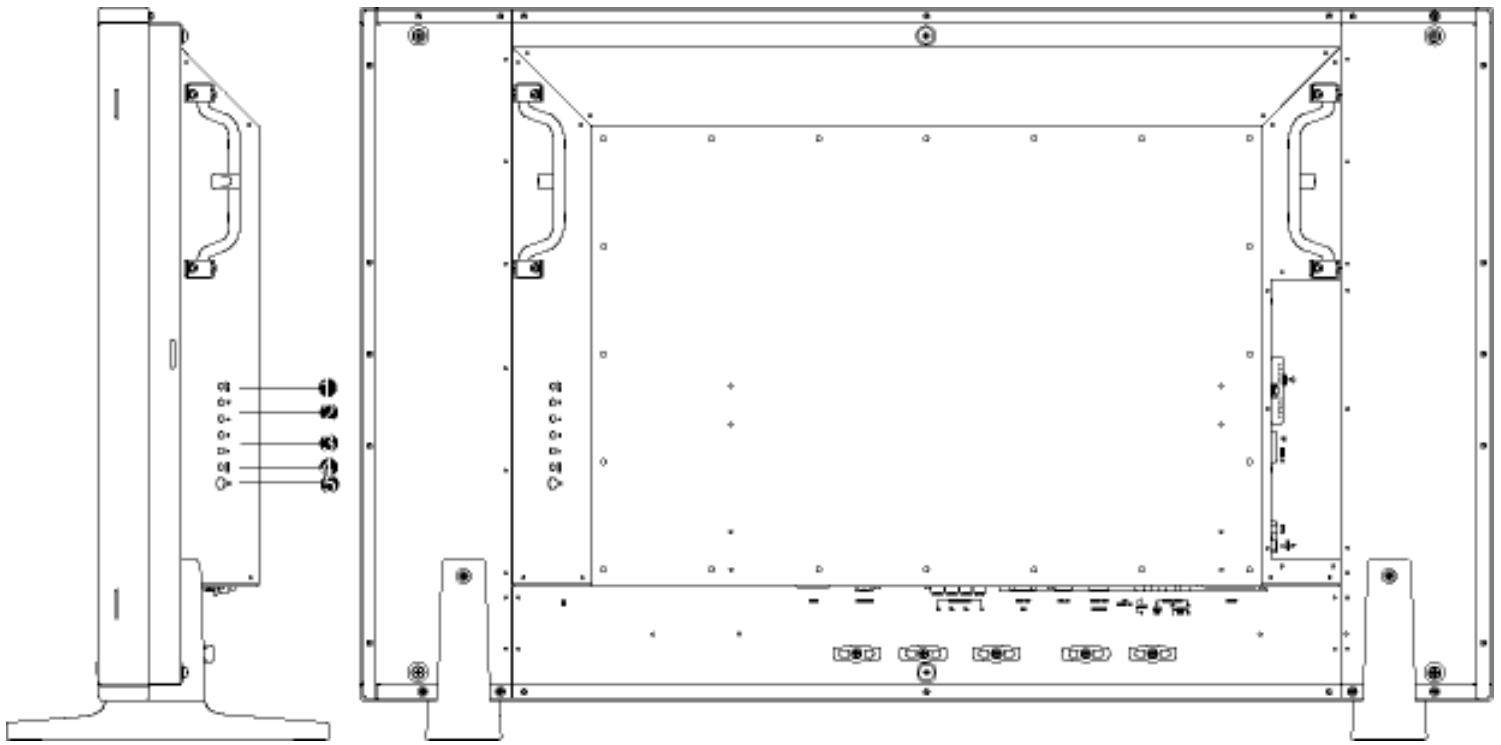

1 **INPUT**

Selecting input source

2 ▼ ▲

Increase or decrease the channel number  
or  
moving up or down to highlight the function in OSD

3 ◀ ▶

Increase or decrease the level of audio volume  
or  
moving left or right to highlight the sub-menu in the selected function  
of OSD

4 **MENU**

Open the OSD or confirm the selected function

5 

DC power switch On/Off

[RETURN TO TOP OF THE PAGE](#)

**Side View (Right)**



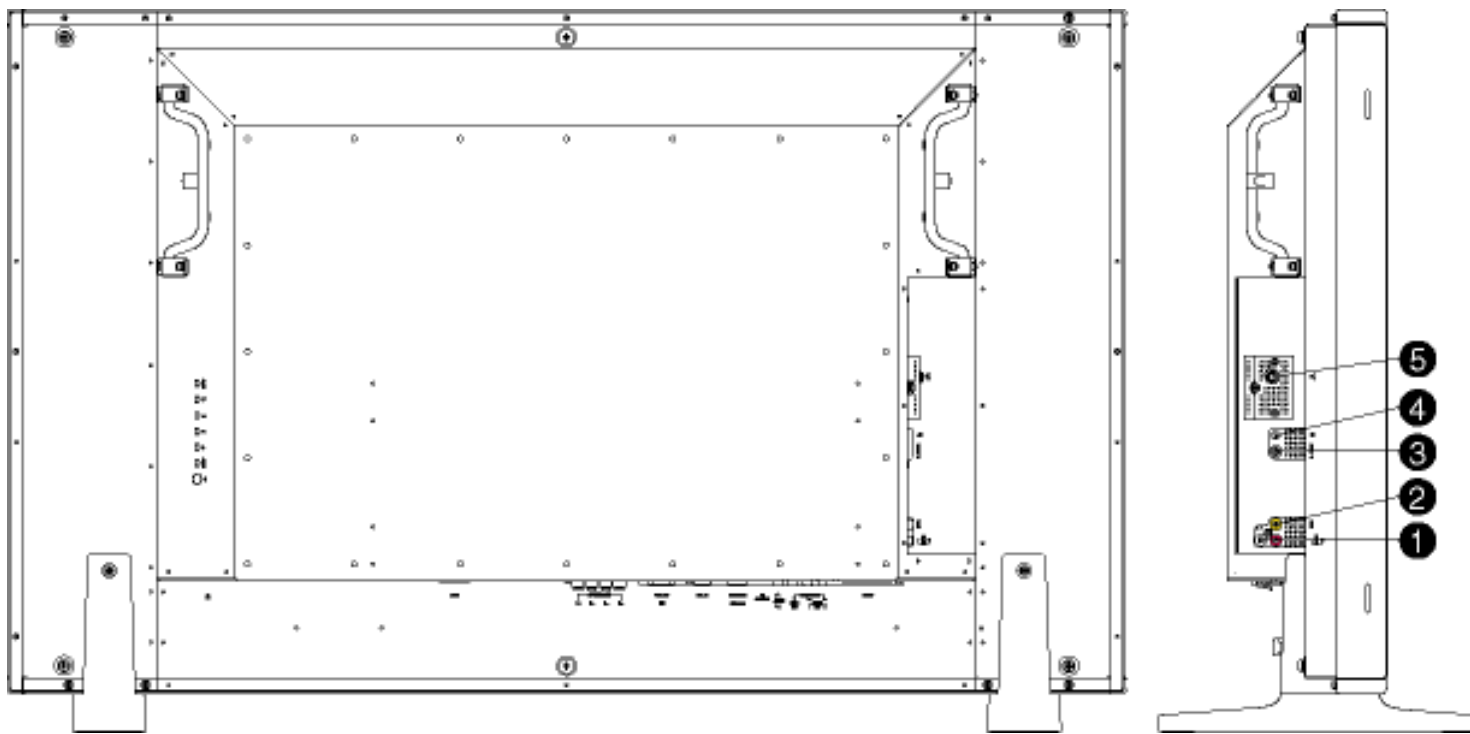

- 1 Audio input for composite input
- 2 Composite input
- 3 S-Video input
- 4 Earphone output
- 5 TV tuner

- Audio (left and right) input for composite signal input.
- Composite (CVBS) signal input
- S-Video signal input
- Earphone output
- TV tuner input (available in TV version only)

[RETURN TO TOP OF THE PAGE](#)

---

## Rear View

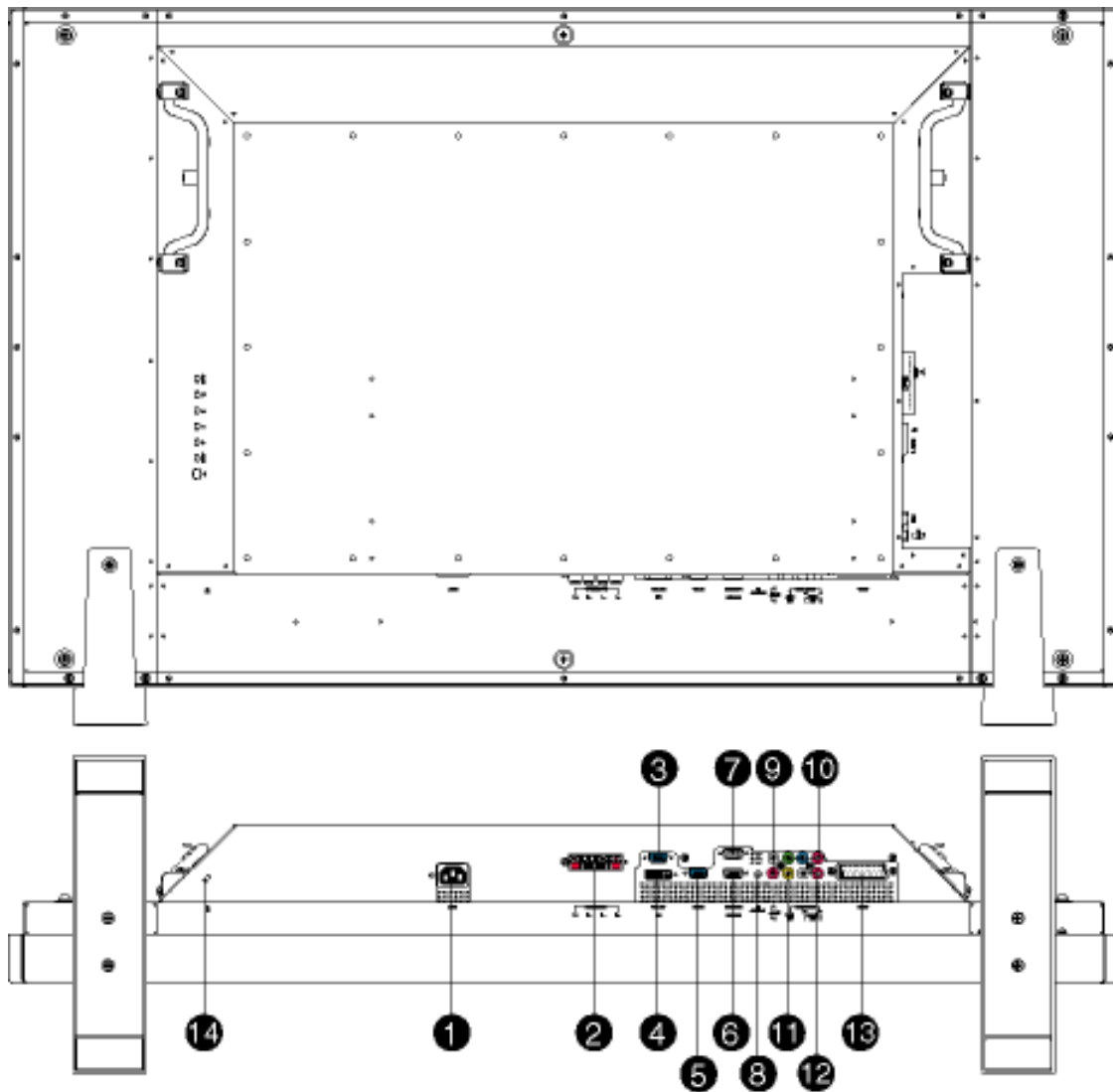

- |   |                 |  |
|---|-----------------|--|
| 1 | AC in           | AC power in  |
| 2 | Speakers output | External speakers output   |
| 3 | D-Sub output    | PC analog D-Sub input  |
| 4 | DVI-D input     | PC digital input   |
| 5 | D-Sub input     | PC analog D-Sub input  |
| 6 | RS232 input     | RS232 network connection Input                                       |
| 7 | RS232 output    | RS232 network connection output for the use of loop through function |
| 8 | PC audio        | PC stereo audio input  |

9	Audio input for component signal	Audio (left and right) input for component signal input
10	Component input	Component (Y <b>P<sub>b</sub></b> P <sub>r</sub> ) signal input
11	Composite output	Composite (CVBS) output for the use of loop through function
12	Audio output for composite output	Audio (left and right) out put for compo site signal out put.
13	External / EURO-AV	SCART connection (for the use of European model only)
14	Kensington lock	Kensington lock

---

## Optimising Performance

- For best performance, ensure that your display settings are set at 1360x768, 60Hz.



**Note:** You can check the current display settings by pressing the 'MENU' button once.

- You can also install the Flat Panel Adjust (FP Adjust) program, a program for getting the best performance out of your monitor. This is included on this CD. Step-by-step instructions are provided to guide you through the installation process. Click on the link to find out more about this program.

More about  [FP\\_setup04.exe](#)

[RETURN TO TOP OF THE PAGE](#)

# On Screen Display

On Screen Display Control • Using Your Remote Control

---

## On Screen Display Controls

An overall view of the On-Screen Display (OSD) structure is shown below. You can use it as a reference for further adjusting your Monitor/TV.

There are two different modes of OSD available for different models:

- [PC Mode](#)
  - [TV Mode](#)
- 

## Main menu

There is a slight difference between PC mode and TV mode: Setup selection is available in TV mode only.

### Sub-menus

Picture: press  to enter sub-menu selections.















#### PC Mode





MAIN CONTROLS	
PICTURE	◦ SMART PICTURE
AUDIO	◦ BRIGHTNESS
FEATURES	◦ CONTRAST
INSTALL	◦ AUTO ADJUST
	◦ MANUAL ADJUST













#### TV Mode

MAIN CONTROLS	
PICTURE	◦ SMART PICTURE
AUDIO	◦ BRIGHTNESS
FEATURES	◦ CONTRAST
INSTALL	◦ COLOR
SETUP	◦ SHARPNESS
	◦ TINT





**PC mode**





Selection	How to use
Smart Picture	<p>In PC mode</p> <ul style="list-style-type: none"> <li>• Users can press  or  to toggle between                             <ul style="list-style-type: none"> <li>◦ Normal</li> <li>◦ Warm</li> <li>◦ Cool</li> </ul> </li> <li>• Press  to next sub-menu selection,  or  to return to main menu.</li> </ul>
Brightness	<p>Adjust image brightness.</p> <ul style="list-style-type: none"> <li>• Press  or  to adjust,</li> <li>• Press  or  to adjacent sub menu selections,</li> <li>• Press  to return to main menu.</li> </ul>
Contrast	<p>Adjust image sharpness.</p> <ul style="list-style-type: none"> <li>• Press  or  to adjust,</li> <li>• Press  to adjacent sub-menu selections,</li> <li>• Press  to return to main menu.</li> </ul>





















<p>Auto Adjust</p>	<p>Automatic fine tuning display geometry and time frequency parameter.</p> <ul style="list-style-type: none"> <li>• Press  to start,</li> <li>• A selection of Store? Yes/No will appear.</li> <li>• Press  or  to toggle between Yes and No.</li> <li>• Press  to confirm and return to sub-menu.</li> </ul>
--------------------	--

<p>Manual Adjust</p>	<p>Adjust display geometry and time frequency parameters.</p> <ul style="list-style-type: none"> <li>• Phase: Press  or  to adjust,  to confirm and return to sub-menu.</li> <li>• Clock: Phase: Press  or  to adjust,  to confirm and return to sub-menu.</li> <li>• Horizontal: Phase: Press  or  to adjust,  to confirm and return to sub-menu.</li> <li>• Vertical: Phase: Press  or  to adjust,  to confirm and return to sub-menu.</li> </ul>
----------------------	--

**TV mode**

<p>Smart Picture</p>	<p>In TV mode</p> <ul style="list-style-type: none"> <li>• Users can press  or  to toggle between             <ul style="list-style-type: none"> <li>○ Personal</li> <li>○ Movies</li> <li>○ Sports</li> <li>○ Weak Signal</li> <li>○ Multimedia</li> <li>○ Night</li> </ul> </li> <li>• Press  to next sub-menu selection,  or  to return to main menu.</li> </ul>
----------------------	--



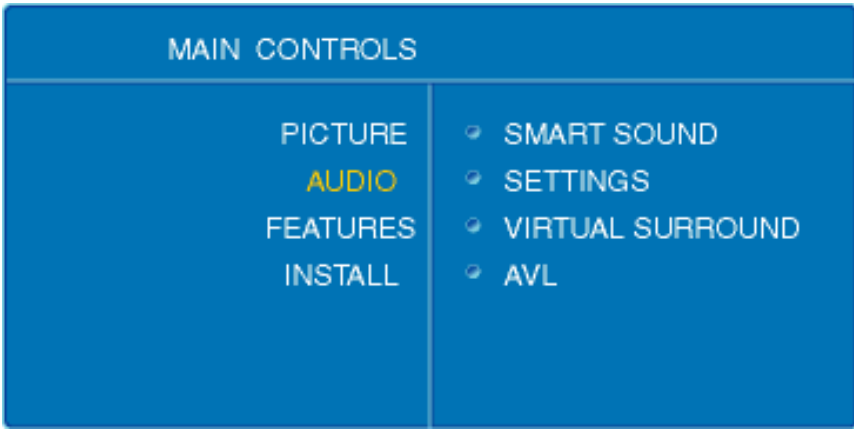

<p>Brightness</p>	<p>Adjust image brightness. It is adjustable only when Smart Picture is in personal mode.</p> <ul style="list-style-type: none"> <li>• Press  or  to adjust,</li> <li>• Press  or  to adjacent sub-menu selections,</li> <li>• Press  to return to main menu.</li> </ul>
-------------------	---



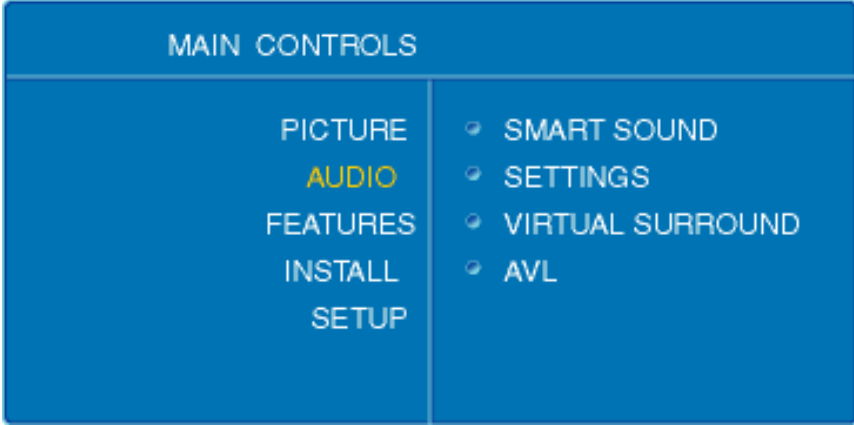



Contrast	<p>Adjust image sharpness. It is adjustable only when Smart Picture is in personal mode.</p> <ul style="list-style-type: none"><li>• Press  or  to adjust,</li><li>• Press  or  to adjacent sub-menu selections,</li><li>• Press  to return to main menu.</li></ul>
Color	<p>Adjust image color saturation. It is adjustable only when Smart Picture is in personal mode.</p> <ul style="list-style-type: none"><li>• Press  or  to adjust,</li><li>• Press  or  to adjacent sub-menu selections,</li><li>• Press  to return to main menu.</li></ul>
Sharpness	<p>Adjust image sharpness. It is adjustable only when Smart Picture is in personal mode.</p> <ul style="list-style-type: none"><li>• Press  or  to adjust,</li><li>• Press  or  to adjacent sub-menu selections,</li><li>• Press  to return to main menu.</li></ul>
Tint	<p>Adjust image hue level.</p> <ul style="list-style-type: none"><li>• Press  or  to adjust,</li><li>• Press  or  to adjacent sub-menu selections,</li><li>• Press  to return to main menu.</li></ul>
<p><b>Audio:</b> press  to enter sub-menu selections</p> <p><b>PC Mode</b></p>	



**TV Mode**







<p>Smart Sound</p>	<p>Preset audio modes.</p> <ul style="list-style-type: none"> <li>• Users can press  or  to toggle between             <ul style="list-style-type: none"> <li>○ Personal</li> <li>○ News</li> <li>○ Music</li> <li>○ Theater</li> </ul> </li> <li>• Press  to next sub-menu selections</li> <li>•  or  to return to main menu.</li> </ul>
--------------------	--

<p>Settings</p>	<p>Adjust audio setting parameters.</p> <ul style="list-style-type: none"> <li>• Users can press  or  to toggle between             <ul style="list-style-type: none"> <li>○ Treble</li> <li>○ Bass</li> <li>○ Balance</li> </ul> </li> <li>• Press  or  to adjacent sub-menu selections</li> <li>•  or  to return to main menu.</li> </ul>
-----------------	---







Virtual Surround Sound

Switch virtual surround effect on or off.

- Users can press  or  to toggle between
  - On
  - Off
- Press  or  to adjacent sub-menu selections,  to return to main menu.

AVL

Auto Volume Limit, adjust volume level automatically to prevent sudden peak load exceeds design limit.

- Users can press  or  to toggle between
  - Yes
  - No
- Press  or  to adjacent sub-menu selections,  to return to main menu.



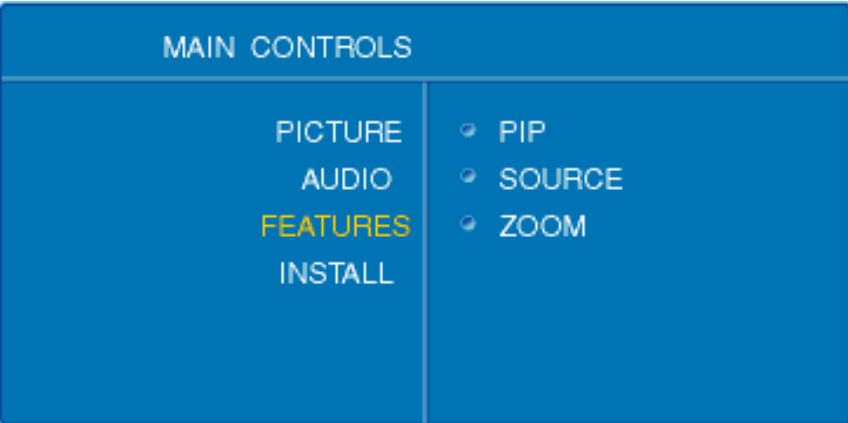



**Features:** press  to enter sub-menu selections.























**PC mode**

PIP

Picture in Picture size choices.





- Press  to enter PIP sub-menu, and press  or  to selection between
  - Size
  - Video
  - Audio
  - Display
- Press  to return from PIP sub-menu to sub-menu, or press  or  to return to main menu.

**PIP Sub-menu**

Size	<p>PIP window size adjustment.</p> <ul style="list-style-type: none"><li>• Users can use  or  to toggle between<ul style="list-style-type: none"><li>○ Small</li><li>○ Medium</li><li>○ Large</li><li>○ PBP</li><li>○ Off</li></ul></li><li>• Press  or  to return to upper level sub-menu,  to next selection.</li></ul>
Video	<p>Video source of the PIP window.</p> <ul style="list-style-type: none"><li>• Users can use  or  to toggle between<ul style="list-style-type: none"><li>○ TV</li><li>○ AV (CVBS)</li><li>○ S-video</li><li>○ EXT (Scart)</li></ul></li><li>• Press  or  to adjacent sub-menu selections,  to return to upper level sub-menu.</li></ul>
Audio	<p>Audio source of the PIP window.</p> <ul style="list-style-type: none"><li>• Users can use  or  to toggle between<ul style="list-style-type: none"><li>○ PC</li><li>○ PIP</li></ul></li><li>• Press  or  to adjacent sub-menu selections,  to return to upper level sub-menu.</li></ul>
Display	<p>PIP window location selection.</p> <ul style="list-style-type: none"><li>• Users can use  or  to toggle between<ul style="list-style-type: none"><li>○ Icon1 (upper right corner of the screen)</li><li>○ Icon2 (lower right corner of the screen)</li><li>○ Icon3 (lower left corner of the screen)</li><li>○ Icon4 (upper left corner of the screen)</li></ul></li><li>• Press  or  to adjacent sub-menu selections,  to return to upper level sub-menu.</li></ul>

Source

Choices of video source for main screen.

- Users can use  or  to toggle between
  - PC
  - DVI
  - HDCP
  - TV
  - AV (CVBS)
  - S-video
  - EXT (Euro connector, Scart)
  - HD (YPbPr)
- Press  or  to adjacent sub-menu selections,  to return to upper level sub-menu.





Zoom

Choices for Zoom function.

- Users can use  to enter next level sub-menu and Zoom sub-menu.



**Zoom sub-menu**



Zoom Type

- Users can use  or  to toggle between
  - Off
  - 4x4
  - 3x3
  - 2x2
  - 1x1
- Press  to confirm and  to return to upper level sub-menu.

Zoom ID

This selections is only available when one of zoom types is chosen. When zoom type is off, this selections is unavailable.

- Users can use  or  to toggle between IDs. For example, when 4x4 is chosen, the ID selection are
 





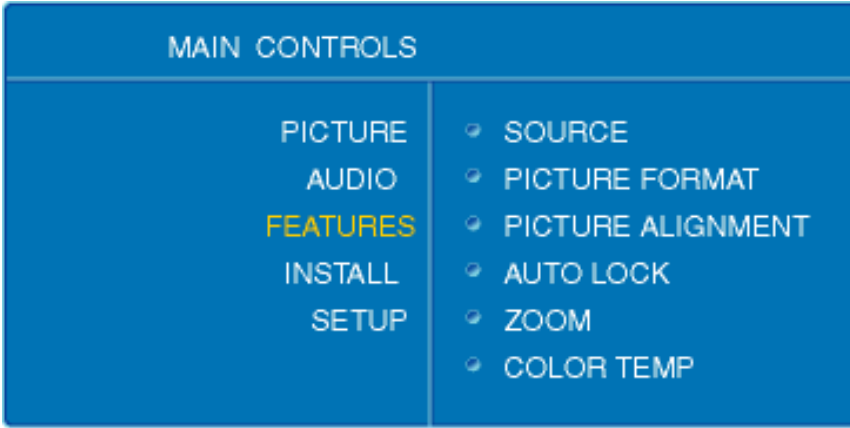

A1	A2	A3	A3
B1	B2	B3	B4
C1	C2	C3	C4
D1	D2	D3	D4
- Press  to confirm and  to return to Zoom Type and exit to upper level sub-menu.

TV mode



Source

Choices of video source for main screen.

- Users can use  or  to toggle between each signal source, then press  to confirm your select.
  - PC
  - DVI
  - HDCP
  - TV
  - AV (CVBS)
  - S-Video
  - Ext (Euro connector, Scart)
  - HD (YP<sub>b</sub>P<sub>r</sub>)
- Press  or  to adjacent sub-menu selections  to return to upper level sub-menu.

Picture Format

Selections of image format.

- Users can use  or  to toggle between
  - Automatic
  - 4:3



- Zoom 16:9





- Wide screen

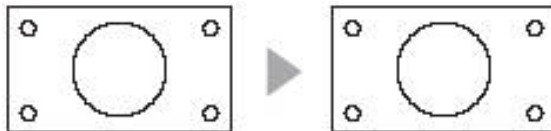

- Super wide



- Press  or  to adjacent sub-menu selections  to return to upper level sub-menu.

Auto Lock

Lock up specific channels to prevent underage viewers to watch improper TV content.

- Users can use  to enter next level sub-menu.
- When you select this function for the first time, a sub-menu will appear and ask you to input access code. You can use number buttons to input a four-digit access code. Then a confirming sub-menu will appear and ask you to input the same access code once more to confirm.
- After the first time, each time you try to access this function, a sub-menu will appear to request for a access code. If the code is correct, you can start the setting process of this function.







**Note:** Please remember that 0711 is a default access code. If

you forget the access code you set or someone else has changed your access code. You can always use 0711 to unlock.

**Auto Lock sub-menu**



Lock Program

Lock selected channel from underage viewers.

- Press  to enter.
- Use  to block the current channel,  to unlock this channel.
- Use number buttons to select the channel you wish to block or unlock.
- Then, use  to confirm and return to upper level sub-menu.



**Change code**

Change program lock access code. Users need to set a four digits access code to enable the Auto Lock function.

- Use  to enter code input mode
- Use number buttons to a new four-digit code
- Press  to confirm and return to upper level sub menu.

**Clear all**

Clear all of the locked channels.

- Press  or  to toggle between
  - On
  - Off
- Press  to confirm and clear up all locked channel settings.

Use  to adjacent upper level sub-menu selections.



**Zoom**

Choices for Zoom function.

- User can use  to enter next level sub-menu, and Zoom sub-menu.



**Zoom sub-menu**

**Zoom Type**



- Users can use  or  to toggle between
  - Off
  - 4x4
  - 3x3
  - 2x2
  - 1x5
- Press  to confirm and  to return to upper level sub-menu.

**Zoom ID**

This selection is only available when one of zoom types is chosen. When zoom type is off, this selection is unavailable.

- Users can use  or  to toggle between IDs. For example, when 4x4 is chosen, the ID selections are

A1	A2	A3	A3
B1	B2	B3	B4
C1	C2	C3	C4
D1	D2	D3	D4



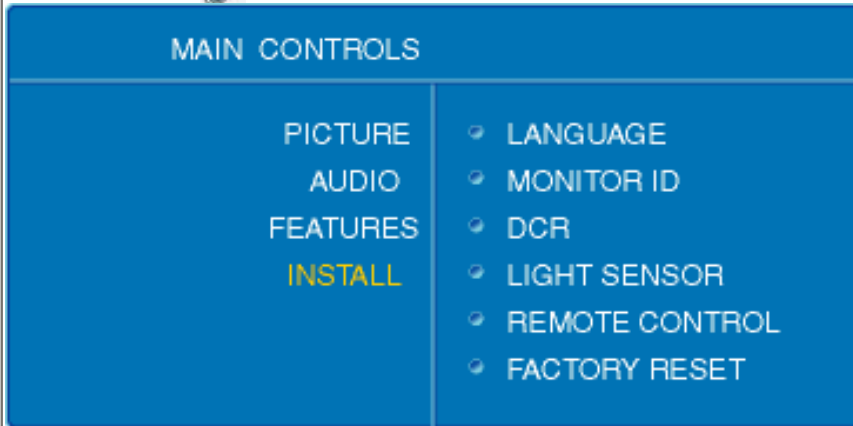

- Press  to confirm and  to return to Zoom Type and exit to upper level sub-menu.

**Install:** press  to enter sub-menu selections.







Language

Choices of languages in user interfaces.

- Users can use  or  to toggle between
  - ENGLISH
  - ESPAÑOL
  - **FRANÇAIS**
  - DEUTSCH
  - ITALIANO
  - 中文
- Press  to adjacent sub-menu selections,  or  to return to main menu.





Monitor ID











Assigning a three digits monitor ID to the unit, so it can be identified when using RS232 to control from remote.

- Use  to enter, and  or  to select 1~9 numbers,  to confirm.

DCR

Dynamic Contrast Ratio, technology to boost display contrast ratio.

- Users can use  or  to toggle between
  - On
  - Off
- Press  or  to adjacent sub-menu selections.







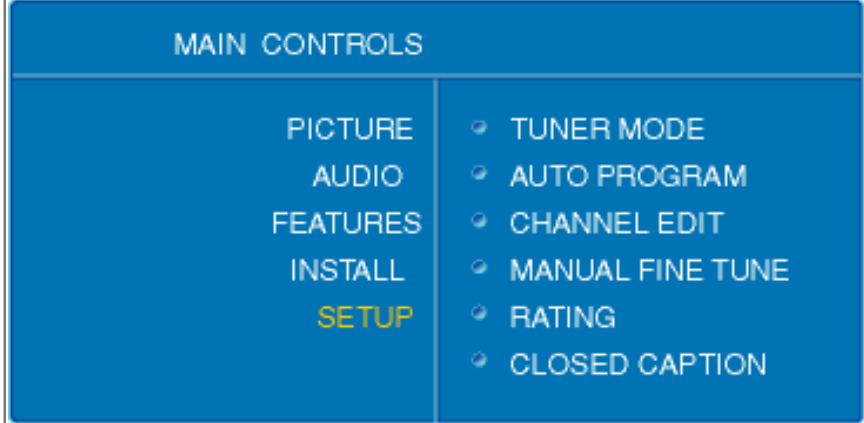















<p>Light Sensor</p>	<p>Turns on or off the light sensor for automatic brightness control.</p> <ul style="list-style-type: none"> <li>• Users can use  or  to toggle between             <ul style="list-style-type: none"> <li>○ On</li> <li>○ Off</li> </ul> </li> <li>• Press  or  to adjacent sub-menu selections.</li> </ul>
<p>Remote Control</p>	<p>Users need to turn off remote control function when they want to use RS232 protocol to control this unit from afar, so it will remote control commands not to conflict with RS232 commands.</p> <ul style="list-style-type: none"> <li>• Users can use  or  to toggle between             <ul style="list-style-type: none"> <li>○ On</li> <li>○ Off</li> </ul> </li> <li>• Press  or  to adjacent sub-menu selections.</li> </ul>
<p>Factory Reset</p>	<p>To reset monitor TV's settings back to factory default.</p> <ul style="list-style-type: none"> <li>• Users can use  or  to toggle between             <ul style="list-style-type: none"> <li>○ No</li> <li>○ Yes</li> </ul> </li> <li>• Press  to confirm.</li> </ul>

















**Setup:** Setup sub-menu is available in TV modes only. Press  to enter the sub-menu selections.

**TV mode (North America model)**







Tuner Mode	<p>Choose of tuner signal inputs.</p> <ul style="list-style-type: none"> <li>• Users can press  or  to toggle between <ul style="list-style-type: none"> <li>○ Antenna</li> <li>○ Cable</li> <li>○ Auto</li> </ul> </li> <li>• Then, press  to adjacent sub-menu selections,  or  to return to main menu.</li> </ul>
Auto Program	<p>Scan all existing channels from your tuner input.</p> <ul style="list-style-type: none"> <li>• Press  to start.</li> <li>• Press  or  to adjacent sub-menu selections,  to return to main menu.</li> </ul>
Channel Edit	<p>Choices to add or delete channels from available channels.</p> <ul style="list-style-type: none"> <li>• Press  to enter Channel Edit sub-menu.</li> <li>• In Channel selection, use  or  to choose the channel that you wish to add or delete.</li> <li>• Then, press  to next selection, use  or  to toggle between <ul style="list-style-type: none"> <li>○ Activate (add)</li> <li>○ Skip (delete)</li> </ul> </li> <li>• Repeat the above two steps to add or delete other channels, or, press  to confirm and return to upper level sub-menu.</li> <li>• Press  or  to adjacent sub-menu selections.</li> </ul>
Manual Fine Tune	<p>In case of weak signal situations, manually fine-tune channel signals to get the best display quality.</p> <ul style="list-style-type: none"> <li>• Users can use  or  to fine tune</li> <li>• Press  or  to adjacent sub-menu selections,  to return to main menu.</li> </ul>

Rating	<p>Movie or TV broadcasters add rating signal in the TV or movie broadcasted. Users can use this function to set up an automatic program rating and blocking mechanism to prevent underage viewers to watch improper movie or TV contents.</p> <ul style="list-style-type: none"> <li>• Press  to enter Rating sub-menu.</li> <li>• Press  or  to adjacent sub-menu selections.</li> </ul>
<b>Rating sub-menu</b>	
Block Option	<p>To enable or disable the TV or Movie block function.</p> <ul style="list-style-type: none"> <li>• Users can use  or  to toggle between <ul style="list-style-type: none"> <li>○ On</li> <li>○ Off</li> </ul> </li> <li>• Press  or  to return to upper level sub- menu ,  to adjacent sub-menu selections.</li> </ul>
Moving Rating	<p>There are seven movie ratings.</p> <ul style="list-style-type: none"> <li>• Users can use  to enter movie rating sub-menu, and use  or  to choose between <ul style="list-style-type: none"> <li>○ G: all ages admitted</li> <li>○ PG: Parental guidance suggested</li> <li>○ PG13: Parents strongly cautioned</li> <li>○ R: Restricted</li> <li>○ NC: No children under the age of 17 will be admitted</li> <li>○ X: Adults only</li> </ul> </li> </ul> <p>(More information will be seen at the end of this section)</p> <ul style="list-style-type: none"> <li>• In each rating selection, users can use  or  to toggle between <ul style="list-style-type: none"> <li>○ On</li> <li>○ Off</li> </ul> </li> </ul> <p> <b>Note:</b> If a lower level rating is blocked, then all the upper level rating will be also blocked automatically. For example, if PG is blocked, then all the rest ratings except G will be blocked.</p> <ul style="list-style-type: none"> <li>• Then, press  to return to upper level sub- menu,  or</li> </ul>



to adjacent sub-menu selections.



There are six movie ratings.

- Users can use  to enter movie rating sub-menu, and use  or  to choose between

1) Y: all children

- Users can use  or  to toggle between
  - On
  - Off



2) Y7: Directed to older children

- Users can use  or  to toggle between
  - Block
  - FV: fantasy violence or comic violence

3) G: General audience

- Users can use  or  to toggle between
  - On
  - Off

4) PG: Parental guidance suggested

- Users can use  or  to toggle between
  - Block
  - V: violence
  - S: sexual situation
  - L: strong language
  - D: suggestive dialogue

to block all programs in this rating or part of the programs with specific contents.

5) 14: Parents strongly cautioned.



- Users can use  or  to toggle between
  - Block
  - V: violence

TV Rating

- S: sexual situation
- L: strong language
- D: suggestive dialogue

to block all programs in this rating or part of the programs with specific contents.

6) MA: Matured audience only.



- Users can use  or  to toggle between
  - Block
  - V: violence
  - S: sexual situation
  - L: strong language
  - D: suggestive dialogue

to block all programs in this rating or part of the programs with specific contents.

(More information will be seen at the end of this section)







**Note:** If a lower level rating is blocked, then all the upper level rating will be also blocked automatically. For example, if Y7 is blocked, then all the rest ratings except Y will be blocked.

- Then, press  to return to upper level sub- menu,  or  to adjacent sub-menu selections.

Closed Caption



Closed caption are captions that are hidden in the video signal, invisible without a special decoder. It allows hearing impaired TV viewers to read ongoing program dialogues or audio effects.

- Users can use  to enter Closed Caption sub-menu. Then use  or  to choose between
  - Caption Mode
  - CC Display
- Press  to return to main menu.

**Closed Caption sub-menu**

There are nine caption modes to be selected.

### Caption Mode



- Users can use  or  to toggle between
  - CC1
  - CC2
  - CC3
  - CC4
  - TXT1
  - TXT2
  - TXT3
  - TXT4
  - CC Mute
- Then, press  to confirm and return to upper level sub-menu.



**Note:** The difference between CC and TXT mode is, CC shows a few lines of dialogues only while TXT (text) use half or entire page to display scrolling text information. CC1 ~CC4 are usually showing same contents in different languages. Text mode likewise.

### CC Display

Users can use CC display to turn on/off closed caption which was set earlier.

- Users can use  or  to toggle between
  - On
  - Off
- Then, press  to confirm and return to upper level sub-menu.



### About Movie Ratings

The movie rating system is set up by Motion Picture Association of America. The main reason is to prevent underage viewers to watch improper movie contents. There are six rating levels, namely G, PG, PG-13, R, NC-17, and X.





**TV mode (Europe, Asia Pacific models)**

## MAIN CONTROLS

- |              |                   |
|--------------|-------------------|
| PICTURE      | ○ AUTO PROGRAM    |
| AUDIO        | ○ MANUAL STORE    |
| FEATURES     | ○ CHANNEL SETTING |
| INSTALL      | ○ SYSTEM          |
| <b>SETUP</b> |                   |





## Auto Program

Scan all existing channels from your tuner input.

- Press  to start.
- Press  or  to adjacent sub-menu selections,  to return to main menu.





## Manual Store

Select a frequency with specific channel.

- Use  to enter Manual Store sub-menu, and  or  to select between selections.
- Then,  to confirm.





## Channel Setting

Choose channel setting to channel edit, channel swap, name edit, and channel sort.



























- Use  to enter Channel Setting sub-menu, and  or  to select between selections.
- Then,  to confirm.





















## System

Select different programs in TV mode.











- Use  to enter System sub-menu, and  or  to select between selections.
- Then,  to confirm.

**Manual Store sub-menu**

System	<ul style="list-style-type: none"> <li>• Users can use  or  to toggle between             <ul style="list-style-type: none"> <li>◦ France: scans pan Europe and French TV systems</li> <li>◦ Western Europe: scans pan Europe TV systems only.</li> </ul> </li> <li>• Press  or  to adjacent sub-menu selections,  to confirm and return to upper level sub-menu.</li> </ul>
Manual Store	<p>Select a frequency with specific channel.</p> <ul style="list-style-type: none"> <li>• Use  to enter, and use  or  to adjust frequency.</li> <li>• Then, press  or  to adjacent sub-menu selections,  to confirm.</li> </ul>
Program Number	<p>Give a channel number to the frequency chose in the above function.</p> <ul style="list-style-type: none"> <li>• Use  to enter, and use  or  to select a number.</li> <li>• Press  or  to adjacent sub-menu selections,  to confirm.</li> </ul>
Fine Tune	<p>Fine tune the channel frequency to get a better display quality.</p> <ul style="list-style-type: none"> <li>• Use  to enter, and use  or  to adjust frequency.</li> <li>• Then, press  or  to adjacent sub-menu selections,  to confirm.</li> </ul>
Store	<ul style="list-style-type: none"> <li>• Use  to enter storing process.</li> <li>• A selection of Store? Yes/No will appear.</li> <li>• Press  or  to toggle between             <ul style="list-style-type: none"> <li>◦ Yes</li> <li>◦ No</li> </ul> </li> <li>• Press  to confirm and return to sub-menu.</li> </ul>

<p>Channel Edit</p>	<p>Choices to add or delete channels from available channels.</p> <ul style="list-style-type: none"> <li>• Press  enter Channel Edit sub-menu</li> <li>• In Channel selection, use  or  to choose the channel that you wish to add or delete.</li> <li>• Then, press  to next selection, use  or  to toggle between             <ul style="list-style-type: none"> <li>◦ Activate (add)</li> <li>◦ Skip (delete)</li> </ul> </li> <li>• Repeat the above two steps to add or delete other channels, or,</li> <li>• Press  to confirm and return to upper level sub-menu</li> <li>• Press  or  to adjacent sub-menu selections.</li> </ul>
<p>Channel Swap</p>	<p>To swap channel numbers between two channels. So users can put preferred channels at front.</p> <ul style="list-style-type: none"> <li>• Users can use  to enter Manual Store sub-menu,</li> <li>•  or  to select between selections.</li> <li>• Then,  to confirm.</li> </ul>
<p><b>Channel Swap sub-menu</b></p>	
<p>From</p>	<p>Choose a channel number to be swapped from.</p> <ul style="list-style-type: none"> <li>• Use  or  to select channel.</li> <li>•  to confirm and return to upper level sub-menu.</li> </ul>
<p>To</p>	<p>Choose a target channel number to be swapped to.</p> <ul style="list-style-type: none"> <li>• Use  or  to select channel.</li> <li>•  to confirm and return to upper level sub-menu.</li> </ul>
<p>Exchange</p>	<p>Execute channel swap.</p> <ul style="list-style-type: none"> <li>• Users can use  to execute the swapping move.</li> </ul>



Name Edit	<p>Modify the channel name from a broadcaster give one to a user preferred one.</p> <ul style="list-style-type: none"><li>• Users can use  to enter</li><li>• Use  or  to select channel.</li><li>• Press  to name input line.</li><li>• Use  or  to select from A to Z,  or  to adjacent alphabet.</li><li>• Press  to confirm and return to upper level sub-menu.</li></ul>
Channel Sort	<p>Sort channel name sequence in alphabetical order, from A to Z. Those channels without a name will be placed at the end of the sequence according to their frequencies, from small to large.</p> <ul style="list-style-type: none"><li>• Users can use  to enter.</li><li>• Press  to start sorting.</li></ul>

[RETURN TO TOP OF THE PAGE](#)







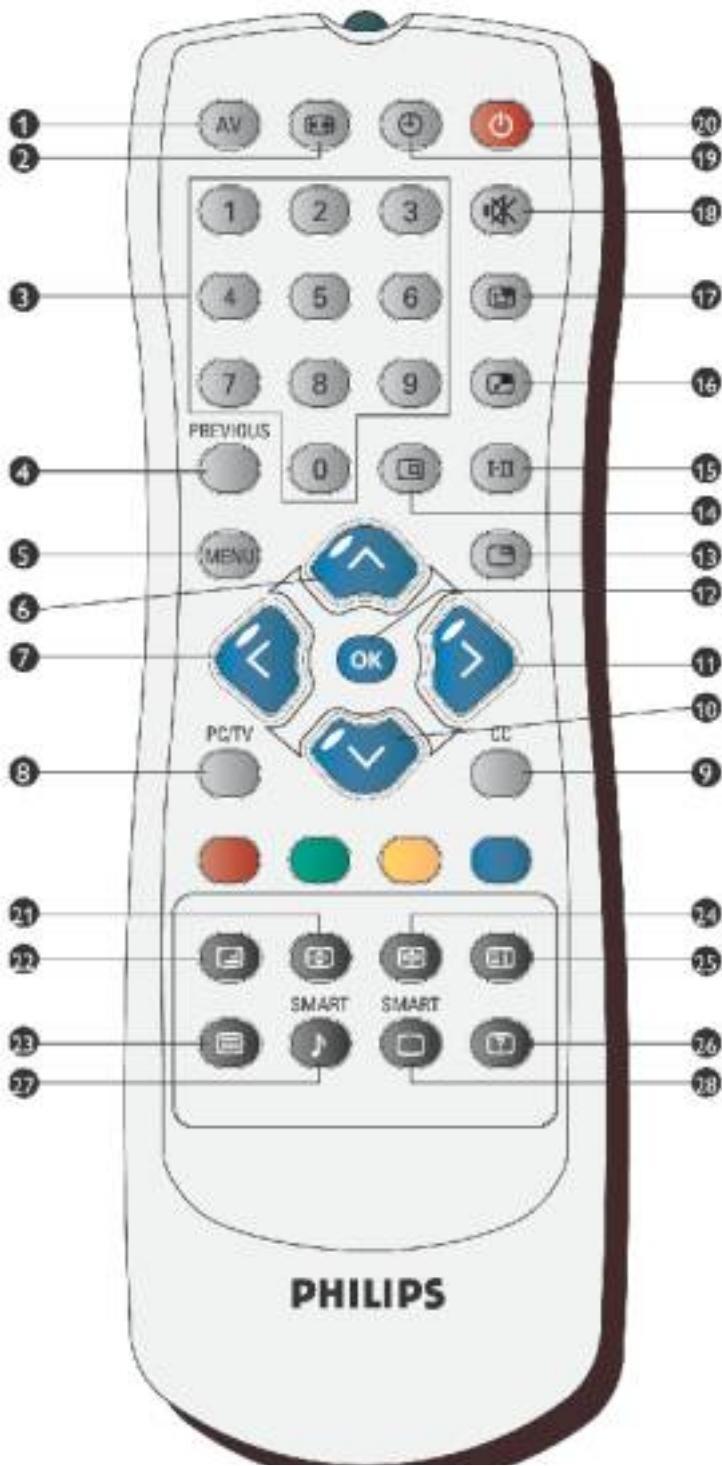



# Remote Control













On Screen Display • Using Your Remote Control







## Using Your Remote Control





1		<p><b>AV source:</b></p> <ul style="list-style-type: none"> <li>• To select TV/video source in TV and also PIP window.</li> <li>• If TV is in Standby mode, press this button to switch to ON.</li> </ul>
2		<p><b>Mode:</b> Screen aspect ratio, switching between 4:3, 16: 9, wide screen, and super wide.</p>
3		<p><b>Numerical keys:</b></p> <ul style="list-style-type: none"> <li>• For direct access to programs.</li> <li>• If TV is in Standby mode, press any number will switch the TV to ON mode.</li> </ul>
4	<p>PREVIOUS</p> 	<p><b>Previous program:</b> Jump to previous TV channel you are viewing.</p>
5		<p><b>Menu:</b> To turn on or off the On-screen-display (OSD) menu</p>
6		<ul style="list-style-type: none"> <li>• Move the cursor up in OS</li> <li>• Channel up</li> </ul>
7		<ul style="list-style-type: none"> <li>• Move the cursor left in OSD</li> <li>• Adjust volume down</li> </ul>
8	<p>PC/TV</p> 	<p>Switching between PC and TV mode.</p>
9	<p>CC</p> 	<p><b>Closed Caption:</b> Functions in North America and Asia Pacific models only.</p>
10		<ul style="list-style-type: none"> <li>• Move the cursor down in OSD</li> <li>• Channel down</li> </ul>

11		<ul style="list-style-type: none"> <li>• Move the cursor right in OSD</li> <li>• Adjust volume up</li> </ul>
12		Confirm the chosen OSD function
13		<b>Freeze:</b> Freeze the screen in video mode or PIP.
14		<b>Status:</b> Display channel number, video/PC mode, and sound mode information.
15		<b>Sound select:</b> <ul style="list-style-type: none"> <li>• To switch between mono and stereo, or to choose between Dual I and Dual II for bilingual transmissions.</li> <li>• For TV sets fitted with NICAM, depends on transmission, you can switch between NICAM stereo and Mono, or between NICAM Dual I, NICAM Dual II, and Mono.</li> </ul>
16		<b>PIP Size:</b> Adjusts Picture-in-Picture (PIP) window size between small, medium, large, picture-by-picture (PBP or split screen), and off.
17		<b>PIP position:</b> Changing PIP window's location on the screen between upper right, lower right, lower left, and upper left.
18		<b>Mute:</b> Disables audio: To enable audio, press the button again.
19		<b>Sleep Timer:</b> Selects a period of time and the unit will switch off automatically.
20		<b>Standby:</b> Sets the TV to standby mode temporary.
27		<b>Smart Sound:</b> Chooses audio effects between Music, Theater, News, and Personal.
28		<b>Smart Picture:</b> Choose picture settings between Sports, Movie, Weak signal, Night, Multimedia, and Personal.
<i>The following buttons are using in Teletext mode only, which are available in Europe and some of the Asia Pacific TV systems.</i>		
21		<b>Teletext Enlarge:</b> Enlarge teletext context to two times larger.

22		<b>Teletext Mix:</b> Teletext background become transparent, content mixes with images.
23		<b>Teletext On/Off:</b> Teletext ON or OFF.
24		<b>Teletext Hold:</b> Freezes the teletext page.
25		<b>Main Index:</b> Press the button to return to the main index.
26		<b>Teletext Reveal/Conceal:</b> To view the concealed text information (e.g. question/answer, quiz, etc.) send by the teletext provider. Press the button can toggle between conceal and reveal mode.
		These four color buttons allow you to access the item or the page indicated by corresponding color in teletext.

**Warning:**

If you are going to control the monitor TV via RS232 interface, to avoid conflict, you need to disable the remote control first. You can enter the OSD menu, select Install, remote control to achieve so. After remote control is disabled, you can use buttons on the unit to enter OSD and enable it, or enable remote control via RS232 command.

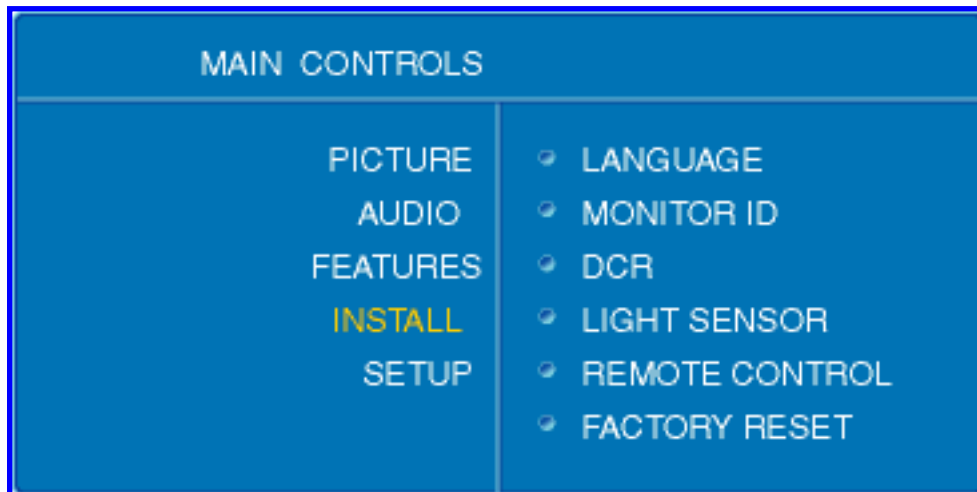

[RETURN TO TOP OF THE PAGE](#)

## Customer Care & Warranty

PLEASE SELECT YOUR COUNTRY/AREA TO REVIEW DETAILS OF YOUR WARRANTY COVERAGE

**WESTERN EUROPE:** Austria • Belgium • Cyprus • Denmark • France • Germany • Greece • Finland • Ireland • Italy • Luxembourg • the Netherlands • Norway • Portugal • Sweden • Switzerland • Spain • United Kingdom

**EASTERN EUROPE:** Czech Republic • Hungary • Poland • Russia • Slovakia • Slovenia • Turkey

**LATIN AMERICA:** Antilles • Argentina • Brasil • Chile • Colombia • Mexico • Paraguay • Peru • Uruguay • Venezuela

**NORTH AMERICA:** Canada • USA

**PACIFIC:** Australia • New Zealand

**ASIA:** Bangladesh • China • Hong Kong • India • Indonesia • Japan • Korea • Malaysia • Pakistan • Philippines • Singapore • Taiwan • Thailand

**AFRICA:** Morocco • South Africa

**MIDDLE EAST:** Dubai • Egypt

---

## Download and Print

[Installing your LCD monitor driver](#) • [Download and Printing Instructions](#) • [Installing FPadjust Program](#)

---

### Installing Your LCD monitor driver

*System requirements:*

- PC running Windows® 95, Windows® 98, Windows® 2000 , Windows® Me, Windows® XP or later
- Find your driver ".inf/.icm/.cat" at : /PC/drivers/

**Read the "Readme.txt" file before installing.**

---

This page provides an option to read the manual in .pdf format. PDF files can be downloaded into your hard disk, then viewed and printed with Acrobat Reader or through your browser.

If you do not have Adobe® Acrobat Reader installed, click on the link to install the application.  
[Adobe® Acrobat Reader for PC](#) / [Adobe® Acrobat Reader for Mac](#).

### **Download instructions:**

To download the file:

1. Click-and-hold your mouse over the icon below. (Win95/98/2000/Me/XP users right-click)

Download



[BDL3221V.pdf](#)

2. From the menu that appears, choose 'Save Link As...', 'Save Target As...' or 'Download Link to Disk'.

3. Choose where you would like to save the file; click 'Save' (if prompted to save as either 'text' or 'source', choose 'source').

### ***Printing instructions:***

To print the manual:

1. With the manual file open, follow your printer's instructions and print the pages you need.

[RETURN TO TOP OF THE PAGE](#)

---

## **Installing FPadjust Program**

The FP Adjust program generates alignment patterns which will help you adjust monitor settings such as CONTRAST, BRIGHTNESS, HORIZONTAL & VERTICAL POSITION, PHASE and CLOCK.

### *System requirements:*

- PC running Windows® 95, Windows® 98, Windows® 2000, Windows® Me, Windows® XP or later

### *To install FPadjust Program:*

- Click on the link or icon to install FPadjustment Program.  
**or**
- Click-and-hold your mouse over the icon. (Win95/98/2000/Me/XP users right-click)



Download



FP\_setup04.exe

- From the menu that appears, choose 'Save Link As...', 'Save Target As...' or 'Download Link to Disk'.
- Choose where you would like to save the file; click 'Save' (if prompted to save as either 'text' or 'source', choose 'source').
- Exit your browser and install the FPadjust Program.

**Read the "FP\_Readme04.txt" file before installing.**

[RETURN TO TOP OF THE PAGE](#)

# FAQs (Frequently Asked Questions)

[Safety and Troubleshooting](#) • [General FAQs](#) • [Screen Adjustments](#) • [Compatibility with Other Peripherals](#) • [LCD Panel Technology](#) • [Ergonomics, Ecology and Safety Standards](#) • [Troubleshooting](#) • [Regulatory Information](#) • [Other Related Information](#)

---

## General FAQs

**Q:** When I install my monitor what should I do if the screen shows 'Cannot display this video mode'?

**A:** Recommended video mode for Philips 32": 1360x768 @60Hz.

1. Unplug all cables, then connect your PC to the monitor that you used previously.
  2. In the Windows Start Menu, select Settings/Control Panel. In the Control Panel Window, select the Display icon. Inside the Display Control Panel, select the 'Settings' tab. Under the setting tab, in box labeled 'desktop area', move the slider to 1360x768 pixels (32").
  3. Open 'Advanced Properties' and set the Refresh Rate to 60Hz, then click OK.
  4. Restart your computer and repeat step 2 and 3 to verify that your PC is set at 1360x768@60Hz (32").
  5. Shut down your computer, disconnect your old monitor and reconnect your Philips LCD monitor.
  6. Turn on your monitor and then turn on your PC.
- 

**Q:** What should I do when screen shows: THIS IS 85HZ OVERSCAN, CHANGE COMPUTER DISPLAY INPUT TO 1360 x 768 @60HZ?

**A:** It means the signal input from your PC is 85Hz -- outside the range that the monitor can display. New Generation LCD intelligent monitor capabilities temporarily override the overscan, providing you with 10 minutes to reset timing to recommended settings.

Here's how:

Go to your Windows Start menu. Select *Settings*, then *Control Panel*. Select *Display*. Move to *Settings* and click on the *Advanced* button. Under *Adaptor*, change the refresh rate to 56~75.

You have 10 minutes to complete the operation; if you do not complete within 10 minutes, power off and re-power on monitor to enter changes.

---

**Q: What does 'refresh rate' mean in connection with an LCD monitor?**

**A:** The refresh rate is of much less relevance for LCD monitors. LCD monitors display a stable, flicker-free image at 60Hz. There is no visible difference between 85Hz and 60Hz.

---

**Q: What are the .inf and .icm files on the CD-ROM? How do I install the drivers (.inf and .icm)?**

**A:** These are the driver files for your monitor. Follow the instructions in your user manual to install the drivers. Your computer may ask you for monitor drivers (.inf and .icm files) or a driver disk when you first install your monitor. Follow the instructions to insert the ( companion CD-ROM) included in this package. Monitor drivers (.inf and .icm files) will be installed automatically.

---

**Q: How do I adjust the resolution?**

**A:** Your video card/graphic driver and monitor together determine the available resolutions. You can select the desired resolution under Windows® Control Panel with the "Display properties".

---

**Q: What if I get lost when I am making monitor adjustments?**

**A:** Simply press the OK button, then select 'Reset' to recall all of the original factory settings.

---

**Q: What is the Auto function?**

**A:** The *AUTO adjustment* key restores the optimal screen position, phase and clock settings at the press of a single button – without the need to navigate through OSD menus and control keys.

**Note:** Auto function is available in selected models only.

---

**Q: My Monitor has no power (Power LED does not light up). What should I do?**

**A:** Make sure the AC power cord is connected to the Monitor.

---

**Q: Will the LCD monitor accept an interlaced signal under PC models?**

**A:** No. If an Interlace signal is used, the screen displays both odd and even horizontal scanning lines at the same time, thus distorting the picture.

---

**Q: What does the Refresh Rate mean for LCD?**

**A:** Unlike CRT display technology, in which the speed of the electron beam is swept from the top to the bottom of the screen determines flicker, an active matrix display uses an active element (TFT) to control each individual pixel and the refresh rate is therefore not really applicable to LCD technology.

---

**Q: Will the LCD screen be resistant to scratches?**

**A:** A protective coating is applied to the surface of the LCD, which is durable to a certain extent (approximately up to the hardness of a 2H pencil). In general, it is recommended that the panel surface is not subject to any excessive shocks or scratches. An optional protective cover with greater scratch resistance is also available.

---

**Q: How should I clean the LCD surface?**

**A:** For normal cleaning, use a clean, soft cloth. For extensive cleaning, please use isopropyl alcohol. Do not use other solvents such as ethyl alcohol, ethanol, acetone, hexane, etc.

---

**Q: Can the Philips LCD Monitor be mounted on the wall or used as a touch panel?**

**A:** Yes. Philips LCD monitors have this optional feature. The standard VESA mount holes on the back cover allows the user to mount the Philips monitor on any VESA standard ARM or accessories. Touch panels are being developed for future applications. Check with your Philips sales representative for more information.

[RETURN TO TOP OF THE PAGE](#)

---

## Screen Adjustments

**Q: What is the FPadjust program on the CD-ROM?**

**A:** The FPadjust program generates alignment patterns that help you adjust monitor settings such as Contrast, Brightness, Horizontal Position, Vertical Position, Phase and Clock for optimal performance.

---

**Q: When I install my monitor, how do I get the best performance from the monitor?**

**A:**

1. For best performance, make sure your display settings are set at 1360x768@60Hz for 32". Note: You can check the current display settings by pressing the OSD OK button once. The current display mode is shown in product information in OSD main controls.
2. To install the Flat Panel Adjust (FPadjust) program located on the monitor setup CD-ROM, open the CD-ROM and double-click the FP\_setup04.exe icon. This will install FP Adjust automatically and place a shortcut on your desktop.
3. Run FPadjust by double clicking the shortcut. Follow the instructions step by step to optimize image performance with your system's video controller.

**Q: How do LCDs compare to CRTs in terms of radiation?**

**A:** Because LCDs do not use an electron gun, they do not generate the same amount of radiation at the screen surface.

[RETURN TO TOP OF THE PAGE](#)

---

**Compatibility with other Peripherals**

**Q: Can I connect my LCD monitor to any PC, workstation or Mac?**

**A:** Yes. All Philips LCD monitors are fully compatible with standard PCs, Macs and workstations. You may need a cable adapter to connect the monitor to your Mac system. Please contact your dealer/retailer for more information.

---

**Q: Are Philips LCD monitors Plug-and-Play?**

**A:** Yes, the monitors are Plug-and-Play compatible with Windows® 95, 98, 2000 and XP.

---

**Q: What is USB (Universal Serial Bus)?**

**A:** Think of USB as a smart plug for PC peripherals. USB automatically determines resources (like driver software and bus bandwidth) required by peripherals. USB makes necessary resources available without user intervention. There are three main benefits of USB. USB eliminates "case anxiety," the fear of removing the computer case to install circuit board cards -- that often requires adjustment of complicated IRQ settings -- for add-on peripherals. USB does away with "port gridlock." Without USB, PCs are normally limited to one printer, two Com port devices (usually a mouse and modem), one Enhanced Parallel Port add-on (scanner or video camera, for example), and a joystick. More and more peripherals for multimedia computers come on the market every day. With USB, up to 127 devices can run simultaneously on one computer. USB permits "hot plug-in." No need to shut down, plug in, reboot and run

set up to install peripherals. No need to go through the reverse process to unplug a device. Bottom line: USB transforms today's "Plug-and-Pray" into true Plug-and-Play!

Please refer to glossary for more information about USB.

---

**Q: What is a USB hub ?**

**A:** A USB hub provides additional connections to the Universal Serial Bus. A hub's upstream port connects a hub to the host, usually a PC. Multiple downstream ports in a hub allows connection to another hub or device, such as a USB keyboard, camera or printer.

[RETURN TO TOP OF THE PAGE](#)

---

## LCD Panel Technology

**Q: What is a Liquid Crystal Display?**

**A:** A Liquid Crystal Display (LCD) is an optical device that is commonly used to display ASCII characters and images on digital items such as watches, calculators, portable game consoles, etc. LCD is the technology used for displays in notebooks and other small computers. Like light-emitting diode and gas-plasma technologies, LCD allows displays to be much thinner than cathode ray tube (CRT) technology. LCD consumes much less power than LED and gas-displays because it works on the principle of blocking light rather than emitting it.

---

**Q: How are LCDs made?**

**A:** LCDs are created from two glass plates separated from each other at a distance of a few microns. The plates are filled with liquid crystal and then sealed together. The top plate is colored with an RGB pattern to make the color filter. Polarizers are then glued to both plates. This combination is sometimes called 'glass' or 'cell.' The LCD cell is assembled into a 'module' by adding the backlight, driver electronics and frame.

---

**Q: What is polarization ?**

**A:** Polarization is basically directing light to shine in one direction. Light is electromagnetic waves. Electric and magnetic fields oscillate in a direction perpendicular to the propagation of the light beam. The direction of these fields is called the 'polarization direction'. Normal or non-polarized light has fields in several directions; polarized light has a field in only one direction.

---

**Q: What differentiates passive matrix LCDs from active matrix LCDs?**

**A:** An LCD is made with either a passive matrix or an active matrix display grid. An active matrix has a transistor located at each pixel intersection, requiring less current to control the luminance of a pixel. For this reason, the current in an active matrix display can be switched on and off more frequently, improving the screen refresh time (your mouse pointer will appear to move more smoothly across the screen, for example). The passive matrix LCD has a grid of conductors with pixels located at each intersection in the grid.

---

**Q: How does a TFT LCD Panel work?**

**A:** On each column and row of the TFT LCD panel, a data source drive and a gate drive are attached, respectively. The TFT drain of each cell is connected to the electrode. The molecular arrangement of liquid crystal elements differ according to whether it is impressed with voltage or not. It varies the direction of polarized light and the amount of light by letting it through different arrays of liquid crystal elements. When two polarized filters are arranged vertically on a polarized light pole, the light that passes through the upper polarized panel is turned 90 degrees along with the spiral structure of the liquid crystal molecules and goes through the polarized filter at the bottom. When impressed with voltage, liquid crystal molecules are arranged vertically from the original spiral structure and the direction of the light is not turned through 90 degrees. In this case, light that comes through the top polarized panel may not go through the polarized panel at the bottom.

---

**Q: What are the advantages of TFT LCD compared with CRT?**

**A:** In a CRT monitor, a gun shoots electrons and general light by colliding polarized electrons on fluorescent glass. Therefore, CRT monitors basically operate with an analog RGB signal. A TFT LCD monitor is a device that displays an input image by operating a liquid crystal panel. The TFT has a fundamentally different structure than a CRT: Each cell has an active matrix structure and independent active elements. A TFT LCD has two glass panels and the space between them is filled with liquid



crystal. When each cell is connected with electrodes and impressed with voltage, the molecular structure of the liquid crystal is altered and controls the amount of inlet lighting to display images. A TFT LCD has several advantages over a CRT, since it can be very thin and no flickering occurs because it does not use the scanning method.

---

**Q: Why is vertical frequency of 60Hz optimal for an LCD monitor?**

**A:** Unlike a CDT monitor, the TFT LCD panel has a fixed resolution. For example, an XGA monitor has 1024x3 (R, G, B) x 768 pixels and a higher resolution may not be available without additional software processing. The panel is designed to optimize the display for a 65MHz dot clock, one of the standards for XGA displays. Since the vertical/horizontal frequency for this dot clock is 60Hz/48kHz, the optimum frequency for this monitor is 60Hz.

---

**Q: What kind of wide-angle technology is available? How does it work?**

**A:** The TFT LCD panel is an element that controls/displays the inlet of a backlight using the dual-refraction of a liquid crystal. Using the property that the projection of inlet light refracts toward the major axis of the liquid element, it controls the direction of inlet light and displays it. Since the refraction ratio of inlet light on liquid crystal varies with the inlet angle of the light, the viewing angle of a TFT is much narrower than that of a CDT. Usually, the viewing angle refers to the point where the contrast ratio is 10. Many ways to widen the viewing angle are currently being developed and the most common approach is to use a wide viewing angle film, which widens the viewing angle by varying the refraction ratio. IPS (In Plane Switching) or MVA (Multi Vertical Aligned) is also used to give a wider viewing angle.

---

**Q: Why is there no flicker on an LCD Monitor?**

**A:** Technically speaking, LCDs do flicker, but the cause of the phenomenon is different from that of a CRT monitor -- and it has no impact of the ease of viewing. Flickering in an LCD monitor relates to usually undetectable luminance caused by the difference between positive and negative voltage. On the other hand, CRT flickering that can irritate the human eye occurs when the on/off action of the fluorescent object becomes visible. Since the reaction speed of liquid crystal in an LCD panel is much slower, this troublesome form of flickering is not present in an LCD display.

---

**Q: Why is an LCD monitor virtually free of Electro Magnetic Interference?**

**A:** Unlike a CRT, an LCD monitor does not have key parts that generate Electro Magnetic Interference, especially magnetic fields. Also, since an LCD display utilizes relatively low power, its power supply is extremely quiet.

[RETURN TO TOP OF THE PAGE](#)

---

## **Ergonomics, Ecology and Safety Standards**

**Q: What is the CE mark?**

**A:** The CE (Conformité Européenne) mark is required to be displayed on all regulated products offered for sale on the European market. This 'CE' mark means that a product complies with the relevant European Directive. A European Directive is a European 'Law' that relates to health, safety, environment and consumer protection, much the same as the U.S. National Electrical Code and UL Standards.

---

**Q: Does the LCD monitor conform to general safety standards?**

**A:** Yes. Philips LCD monitors conform to the guidelines of MPR-II and TCO 99/03 standards for the control of radiation, electromagnetic waves, energy reduction, electrical safety in the work environment and recyclability. The specification page provides detailed data on safety standards.

**More information is provided in the [Regulatory Information](#) section.**



[RETURN TO TOP OF THE PAGE](#)

# Troubleshooting

[Safety and Troubleshooting](#) • 
 [FAQs](#) • 
 [Common Problems](#) • 
 [TV and Audio Problems](#) • 
 [Video Problems](#) • 
 [Remote Control Problems](#) • 
 [Product Specific Problems](#) • 
 [OSD Warning Message](#) • 
 [Regulatory Information](#) • 
 [Other Related Information](#)

This page deals with problems that can be corrected by the user. If the problem still persists after you have tried these solutions, contact your nearest Philips dealer.

<b>Common Problems</b>		
<b>Symptoms</b>	<b>Having this problem?</b>	<b>Check these items</b>
No Video/ Power LED off	No picture, the LCD Monitor TV is not working	<ul style="list-style-type: none"> <li>● Check connection integrity at both ends of the video cable and/or power cord.</li> <li>● Electric outlet verification</li> <li>● Ensure AC power at the rear of the monitor TV is switched on.</li> </ul>
No Video/ Power LED on	No picture or no brightness	<ul style="list-style-type: none"> <li>● Increase brightness and contrast controls.</li> <li>● Perform the LCD Monitor TV self-test feature check.</li> <li>● Check for bent or broken pins in video cable connector.</li> </ul>
Poor Focus	Picture is fuzzy, blurry or ghosting	<ul style="list-style-type: none"> <li>● Auto adjust image through Menu -&gt; Image Setting -&gt; Auto Adjust.</li> <li>● Adjust Phase and Clock controls via OSD.</li> <li>● Eliminate video extension cables.</li> <li>● Perform the LCD Monitor TV factory reset (via Menu -&gt; Factory Reset -&gt; All Settings).</li> <li>● Lower video resolution or increase font size.</li> </ul>

<p>Shaky/Jittery Video</p>	<p>Wavy picture or fine movement</p>	<ul style="list-style-type: none"> <li>• Auto adjust image through Menu -&gt; Image Setting -&gt; Auto Adjust</li> <li>• Adjust Phase and Clock controls via OSD</li> <li>• Perform the LCD Monitor TV factory reset (via Menu -&gt; Factory Reset -&gt; All Settings)</li> <li>• Check environmental factors</li> <li>• Relocate and test in other room</li> </ul>
<p>Missing Pixels</p>	<p>LCD screen has spots</p>	<ul style="list-style-type: none"> <li>• Cycle power on-off</li> <li>• These are pixels that are permanently off and is a natural defect that occurs in LCD technology</li> </ul>
<p>Stuck-on Pixels</p>	<p>LCD screen has bright spots</p>	<ul style="list-style-type: none"> <li>• Cycle power on-off</li> <li>• These are pixels that are permanently on and is a natural defect that occurs in LCD technology</li> </ul>
<p>Brightness Problems</p>	<p>Picture too dim or too bright</p>	<ul style="list-style-type: none"> <li>• Perform the LCD Monitor TV factory reset (via Menu -&gt; Factory Reset -&gt; All Settings)</li> <li>• Auto adjust image through Menu -&gt; Image Setting -&gt; Auto Adjust</li> <li>• Adjust brightness &amp; contrast controls</li> </ul> <p> <b>Note: When operating in DVI mode, the contrast adjustment is not available.</b></p>
<p>Geometric Distortion</p>	<p>Screen not centered correctly</p>	<ul style="list-style-type: none"> <li>• Perform the LCD Monitor TV reset on "Position Settings Only"</li> <li>• Auto adjust image through Menu -&gt; Image Setting -&gt; Auto Adjust</li> <li>• Adjust the centering controls</li> <li>• Ensure the LCD Monitor TV is in proper video mode</li> </ul> <p> <b>Note: When operating in DVI mode, the positioning adjustments are not available.</b></p>

<p>Horizontal/Vertical Lines</p>	<p>Screen has one or more lines</p>	<ul style="list-style-type: none"> <li>● Perform the LCD Monitor TV reset</li> <li>● Auto adjust image through Menu -&gt; Image Setting -&gt; Auto Adjust</li> <li>● Adjust Phase and Clock controls via OSD</li> <li>● Perform the LCD Monitor TV self-test feature check and determine if these lines are also in self-test mode</li> <li>● Check for bent or broken pins in the video cable connector</li> </ul> <p> <b>Note: When operating in DVI mode, the Pixel Clock and Phase adjustments are not available.</b></p>
<p>Sync Problems</p>	<p>Screen is scrambled or appears torn</p>	<ul style="list-style-type: none"> <li>● Perform the LCD Monitor TV reset</li> <li>● Push Auto Adjust button</li> <li>● Adjust Phase and Clock controls via OSD</li> <li>● Perform the LCD Monitor TV self-test feature check to determine if scrambled screen appears in self-test mode</li> <li>● Check for bent or broken pins</li> <li>● Boot up in the "safe mode"</li> </ul>
<p>LCD Scratched</p>	<p>Screen has scratches or smudges</p>	<ul style="list-style-type: none"> <li>● Turn the LCD Monitor TV off and clean the screen</li> </ul>
<p>Safety Related Issues</p>	<p>Visible signs of smoke or sparks</p>	<ul style="list-style-type: none"> <li>● Do not perform any troubleshooting steps</li> <li>● The LCD Monitor TV needs to be replaced</li> </ul>
<p>Intermittent Problems</p>	<p>The LCD Monitor TV malfunctions on &amp; off</p>	<ul style="list-style-type: none"> <li>● Ensure the LCD Monitor TV is in proper video mode</li> <li>● Ensure video cable connection between computer and the LCD monitor TV is secured</li> <li>● Perform the LCD Monitor TV factory reset (via Menu -&gt; Factory Reset -&gt; All Settings)</li> <li>● Perform the LCD Monitor TV self-test feature check to determine if the intermittent problem occurs in self-test mode</li> </ul>

## TV and Audio Problems

<p>Poor TV signal reception</p>	<p>Abnormal picture seen from the screen</p>	<ul style="list-style-type: none"> <li>• The proximity of mountains or high buildings may be responsible for ghost pictures, echoing or shadows. In this case, try manually adjusting your pictures: see 'fine tuning' or adjust the direction of the outside aerial. For Asia users in non-NTSC area: Does your antenna enable you to receive broadcasts in this frequency range (UHF or VHF band)? In the event of difficult reception (snowy pictures) switch the NR on the PICTURE menu to ON.</li> </ul>
<p>No TV picture</p>	<p>No picture when TV input was selected</p>	<ul style="list-style-type: none"> <li>• Have you connected the aerial socket properly? Have you chosen the right system? Poorly connected SCART cables or aerial sockets are often the cause of picture or sound problems (sometimes the connectors can become half disconnected if the LCD Monitor TV set is moved or turned). Check all connections.</li> </ul>
<p>No sound</p>	<p>No sound output when a program with sound was playing</p>	<ul style="list-style-type: none"> <li>• Ensure that the audio cables are firmly connected to both the audio input connectors on your the LCD Monitor TV and audio output connectors on your PC or Video player.</li> <li>• If on certain TV channels you receive a picture but no sound, this means that you do not have the correct TV system. Modify the SYSTEM setting.</li> </ul>

## Video Problems

<p>No Video</p>	<p>No signal indicator is displayed.</p>	<ul style="list-style-type: none"> <li>● Check Video Input Selection                             <ul style="list-style-type: none"> <li>○ Composite: Yellow colored RCA jack</li> <li>○ S-Video: Typically a round 4 pin jack</li> <li>○ Component: Typically 3 RCA jacks of Green, Red and Blue.</li> </ul> </li> <li>● Make sure you did not plug the video cable to video output port behind the LCD monitor TV.</li> </ul>
<p>Low Quality DVD playback</p>	<p>Picture not crisp and some color distortion</p>	<ul style="list-style-type: none"> <li>● Check DVD connection                             <ul style="list-style-type: none"> <li>○ Composite gives good picture</li> <li>○ S-Video gives better picture</li> <li>○ Component gives best picture</li> </ul> </li> </ul>
<p>No sound</p>	<p>See video but no audio</p>	<ul style="list-style-type: none"> <li>● Check if the LCD Monitor TV volume is turn off of muted.</li> <li>● Connect the audio cable securely.</li> <li>● Audio cable is connected incorrectly.</li> <li>● Verify that the audio source is selected correctly in the OSD.</li> </ul>

### Remote Control Problems

<p>Remote control does not work properly</p>	<p>No response from the LCD Monitor TV when remote is pressed</p>	<ul style="list-style-type: none"> <li>● Point the remote control directly at the remote sensor on the LCD Monitor TV.</li> <li>● Replace both batteries with new ones.</li> <li>● Make sure the remote control is not disabled (for disable/enable the remote control, please refer to the section of <a href="#">Remote Control</a>).</li> </ul>
--	---	--

### Product Specific Problems

<p>Screen image is too small</p>	<p>Image is centered on screen, but does not fill entire viewing area</p>	<ul style="list-style-type: none"> <li>● Perform the LCD Monitor TV factory reset (via Menu -&gt; Factory Reset -&gt; All Settings).</li> </ul>
----------------------------------	---	---

Cannot adjust the LCD Monitor TV with the buttons at the side of the unit

OSD does not appear on the screen

- Turn the LCD Monitor TV off and unplug the power cord and then plug back and power on.

For further assistance, refer to the [Consumer Information Centers](#) list and contact your local Philips distributor.

[RETURN TO TOP OF THE PAGE](#)

## OSD Warning Messages

A warning message may appear on the screen indicating the LCD Monitor TV current status.

### ATTENTION

**AUTO ADJUSTMENT IN  
PROGRESS**

When user sees this warning message, it means that the LCD Monitor TV is in adjustment process.



### ATTENTION

**CANNOT DISPLAY THIS VIDEO  
MODE, CHANGE COMPUTE DISPLAY  
INPUT TO 1360X768@60Hz**

A warning message may appear on the screen indicating that the LCD Monitor TV is out of sync range.

See Specifications for the Horizontal and Vertical frequency ranges addressable by this the LCD Monitor TV. Recommended mode is 1360 x 768 @ 60Hz.

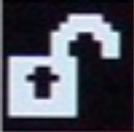

<p><b>ATTENTION</b></p> <p><b>NO VIDEO INPUT SIGNAL</b></p>	<p>This message means that there is no video input signal.</p>
<p><b>ATTENTION</b></p> <p><b>IN POWER SAVING MODE PRESS ANY KEY ON KEYBOARD OR MOVE MOUSE</b></p>	<p>The LCD Monitor TV is in a power saving mode (in PC mode).</p>
	<p>The main OSD menu is unlocked.</p>
	<p>The main OSD menu is locked.</p>

[RETURN TO TOP OF THE PAGE](#)

## Regulatory Information

[CE Declaration of Conformity](#) • [Display Power Management Signaling](#) • [Federal Communications Commission \(FCC\) Notice \(U.S. Only\)](#) • [Commission Federale de la Communication \(FCC Declaration\)](#) • [EN 55022 Compliance \(Czech Republic Only\)](#) • [VCCI Class 2 Notice \(Japan Only\)](#) • [MIC Notice \(South Korea Only\)](#) • [Polish Center for Testing and Certification Notice](#) • [North Europe \(Nordic Countries\) Information](#) • [BSMI Notice \(Taiwan Only\)](#) • [Ergonomie Hinweis \(nur Deutschland\)](#) • [Philips End-of-Life Disposal](#) • [Information for UK only](#) • [Waste Electrical and Electronic Equipment-WEEE](#)

[Safety and Troubleshooting](#) • [Troubleshooting](#) • [Other Related Information](#) • [Frequently Asked Questions \(FAQs\)](#)

---

### CE Declaration of Conformity

Philips Consumer Electronics declare under our responsibility that the product is in conformity with the following standards

- EN60950-1:2001 (Safety requirement of Information Technology Equipment)
  - EN55022:1998 (Radio Disturbance requirement of Information Technology Equipment)
  - EN55024:1998 (Immunity requirement of Information Technology Equipment)
  - EN61000-3-2:2000 (Limits for Harmonic Current Emission)
  - EN61000-3-3:1995 (Limitation of Voltage Fluctuation and Flicker)
  - EN55013:1990+A12+A13+A14 (Radio Disturbance requirement of Sound and Television Receivers and associated)
  - EN55020:1994+A12 (Immunity requirement of Sound and Television Receivers and associated)
  - IEC Guide 112:2000 ( Guide on the Safety of Multimedia Equipment) following provisions of directives applicable
  - 73/23/EEC (Low Voltage Directive)
  - 89/336/EEC (EMC Directive)
  - 93/68/EEC (Amendment of EMC and Low Voltage Directive)
- and is produced by a manufacturing organization on ISO9000 level.

The product also comply with the following standards

- ISO9241-3, ISO9241-7, ISO9241-8 (Ergonomic requirement for Visual Display)
- ISO13406-2 (Ergonomic requirement for Flat panels)
- GS EK1-2000 (GS specification)
- prEN50279:1998 (Low Frequency Electric and Magnetic fields for Visual Display)
- MPR-II (MPR:1990:8/1990:10 Low Frequency Electric and Magnetic fields)
- TCO99, TCO03 (Requirement for Environment Labelling of Ergonomics, Energy, Ecology and Emission, TCO: Swedish Confederation of Professional Employees) for TCO versions

[RETURN TO TOP OF THE PAGE](#)

---

## Display Power Management Signaling

### BDL3221V

This monitor is equipped with a function for saving energy which supports the VESA Display Power Management Signaling (DPMS) standard. This means that the monitor must be connected to a computer which supports VESA DPMS to fulfill the requirements in the NUTEK specification 803299/94. Time settings are adjusted from the system unit by software.

NUTEK	VESA State	LED Indicator	Power Consumption
Normal operation	ON	Blue	100 W (typical)
Power Saving Alternative 2 One step	OFF(Sleep)	Amber	< 5 W
	Switch OFF	OFF	< 3 W



We recommend you switch off the monitor when it is not in use for quite a long time.

[RETURN TO TOP OF THE PAGE](#)

---

## Federal Communications Commission (FCC) Notice (U.S. Only)



This equipment has been tested and found to comply with the limits for a Class B digital device, pursuant to Part 15 of the FCC Rules. These limits are designed to provide reasonable protection against harmful interference in a residential installation. This equipment generates, uses and can radiate radio frequency energy and, if not installed and used in accordance with the instructions, may cause harmful interference to radio communications. However, there is no guarantee that interference will not occur in a particular installation. If this equipment does cause harmful interference to radio or television reception, which can be determined by turning the equipment off and on, the user is encouraged to try to correct the interference by one or more of the following measures:

- Reorient or relocate the receiving antenna.
- Increase the separation between the equipment and receiver.
- Connect the equipment into an outlet on a circuit different from that to which the receiver is connected.
- Consult the dealer or an experienced radio/TV technician for help.



Changes or modifications not expressly approved by the party responsible for compliance could void the user's authority to operate the equipment.

Use only RF shielded cable that was supplied with the monitor when connecting this monitor to a computer device.

To prevent damage which may result in fire or shock hazard, do not expose this appliance to rain or excessive moisture.

THIS CLASS B DIGITAL APPARATUS MEETS ALL REQUIREMENTS OF THE CANADIAN INTERFERENCE-CAUSING EQUIPMENT REGULATIONS.

[RETURN TO TOP OF THE PAGE](#)

---

[Commission Federale de la Communication \(FCC Declaration\)](#)



Cet équipement a été testé et déclaré conforme aux limites des appareils numériques de class B, aux termes de l'article 15 Des règles de la FCC. Ces limites sont conçues de façon à fournir une protection raisonnable contre les interférences nuisibles dans le cadre d'une installation résidentielle. CET appareil produit, utilise et peut émettre des hyperfréquences qui, si l'appareil n'est pas installé et utilisé selon les consignes données, peuvent causer des interférences nuisibles aux communications radio. Cependant, rien ne peut garantir l'absence d'interférences dans le cadre d'une installation particulière. Si cet appareil est la cause d'interférences nuisibles pour la réception des signaux de radio ou de télévision, ce qui peut être décelé en fermant l'équipement, puis en le remettant en fonction, l'utilisateur pourrait essayer de corriger la situation en prenant les mesures suivantes:

- Réorienter ou déplacer l'antenne de réception.
- Augmenter la distance entre l'équipement et le récepteur.
- Brancher l'équipement sur un autre circuit que celui utilisé par le récepteur.
- Demander l'aide du marchand ou d'un technicien chevronné en radio/télévision.



Toutes modifications n'ayant pas reçu l'approbation des services compétents en matière de conformité est susceptible d'interdire à l'utilisateur l'usage du présent équipement.

N'utiliser que des câbles RF armés pour les connections avec des ordinateurs ou périphériques.

CET APPAREIL NUMERIQUE DE LA CLASSE B RESPECTE TOUTES LES EXIGENCES DU REGLEMENT SUR LE MATERIEL BROUILLEUR DU CANADA.

[RETURN TO TOP OF THE PAGE](#)

## EN 55022 Compliance (Czech Republic Only)

This device belongs to category B devices as described in EN 55022, unless it is specifically stated that it is a Class A device on the specification label. The following applies to devices in Class A of EN 55022 (radius of protection up to 30 meters). The user of the device is obliged to take all steps necessary to remove sources of interference to telecommunication or other devices.

Pokud není na typovém štítku počítače uvedeno, že spadá do do třídy A podle EN 55022, spadá automaticky do třídy B podle EN 55022. Pro zařízení zařazená do třídy A (chranné pásmo 30m) podle EN 55022 platí následující. Dojde-li k rušení telekomunikačních nebo jiných zařízení je uživatel povinen provést taková opatření, aby rušení odstranil.

[RETURN TO TOP OF THE PAGE](#)

## VCCI Notice (Japan Only)

This is a Class B product based on the standard of the Voluntary Control Council for Interference (VCCI) for Information technology equipment. If this equipment is used near a radio or television receiver in a domestic environment, it may cause radio Interference. Install and use the equipment according to the instruction manual.



Class B ITE

この装置は、情報処理装置等電波障害自主規制協議会 (VCCI) の基準に基づくクラス B 情報技術装置です。この装置は家庭環境で使用することを目的としていますが、この装置がラジオやテレビジョン受信機に近接して使用されると、受信障害を引き起こすことがあります。取扱説明書に従って正しい取り扱いをして下さい。

[RETURN TO TOP OF THE PAGE](#)

## MIC Notice (South Korea Only)

Class B Device

장치 종류	사용자 안내문
B급 기기	이 장치는 가정용으로 전자파 적합등록을 한 장치로서 주거지역에서는 물론 모든 지역에서 사용할 수 있습니다.



Please note that this device has been approved for non-business purposes and may be used in any environment, including residential areas.

[RETURN TO TOP OF THE PAGE](#)

## Polish Center for Testing and Certification Notice

The equipment should draw power from a socket with an attached protection circuit (a three-prong socket). All equipment that works together (computer, monitor, printer, and so on) should have the same power supply source.

The phasing conductor of the room's electrical installation should have a reserve short-circuit protection device in the form of a fuse with a nominal value no larger than 16 amperes (A).

To completely switch off the equipment, the power supply cable must be removed from the power supply socket, which should be located near the equipment and easily accessible.

A protection mark "B" confirms that the equipment is in compliance with the protection usage requirements of standards PN-93/T-42107 and PN-89/E-06251.

### ***Wymagania Polskiego Centrum Badań i Certyfikacji***

Urządzenie powinno być zasilane z gniazda z przyłączonym obwodem ochronnym (gniazdo z kołkiem). Współpracujące ze sobą urządzenia (komputer, monitor, drukarka) powinny być zasilane z tego samego źródła.

Instalacja elektryczna pomieszczenia powinna zawierać w przewodzie fazowym rezerwową ochronę przed zwarciami, w postaci bezpiecznika o wartości znamionowej nie większej niż 16A (amperów).

W celu całkowitego wyłączenia urządzenia z sieci zasilania, należy wyjąć wtyczkę kabla zasilającego z gniazda, które powinno znajdować się w pobliżu urządzenia i być łatwo dostępne.

Znak bezpieczeństwa "B" potwierdza zgodność urządzenia z wymaganiami bezpieczeństwa użytkowania zawartymi w PN-93/T-42107 i PN-89/E-06251.

### ***Pozostałe instrukcje bezpieczeństwa***

- Nie należy używać wtyczek adapterowych lub usuwać kołka obwodu ochronnego z wtyczki. Jeżeli konieczne jest użycie przedłużacza to należy użyć przedłużacza 3-żyłowego z prawidłowo połączonym przewodem ochronnym.
- System komputerowy należy zabezpieczyć przed nagłymi, chwilowymi wzrostami lub spadkami napięcia, używając eliminatora przepięć, urządzenia dopasowującego lub bezzakłóceniewego źródła zasilania.
- Należy upewnić się, aby nic nie leżało na kablach systemu komputerowego, oraz aby kable nie były umieszczone w miejscu, gdzie można byłoby na nie nadeptywać lub potykać się o nie.
- Nie należy rozlewać napojów ani innych płynów na system komputerowy.
- Nie należy wpychać żadnych przedmiotów do otworów systemu komputerowego, gdyż może to spowodować pożar lub porażenie prądem, poprzez zwarcie elementów wewnętrznych.
- System komputerowy powinien znajdować się z dala od grzejników i źródeł ciepła. Ponadto, nie należy blokować otworów wentylacyjnych. Należy unikać kładzenia luźnych papierów pod komputer oraz umieszczania komputera w ciasnym miejscu bez możliwości cyrkulacji powietrza wokół niego.

[RETURN TO TOP OF THE PAGE](#)

---

## North Europe (Nordic Countries) Information

Placering/Ventilation

### **VARNING:**

FÖRSÄKRA DIG OM ATT HUVUDBRYTARE OCH UTTAG ÄR LÄTÅTKOMLIGA, NÄR DU STÄLLER DIN UTRUSTNING PÅPLATS.

Placering/Ventilation

### **ADVARSEL:**

SØRG VED PLACERINGEN FOR, AT NETLEDNINGENS STIK OG STIKKONTAKT ER NEMT TILGÆNGELIGE.

Paikka/Ilmankierto

### **VAROITUS:**

SIJOITA LAITE SITEN, ETTÄ VERKKOJOHTO VOIDAAN TARVITTAESSA HELPOSTI IRROTTAA PISTORASIESTA.

Plassering/Ventilasjon

### **ADVARSEL:**

NÅR DETTE UTSTYRET PLASSERES, MÅ DU PASSE PÅ AT KONTAKTENE FOR STØMTILFØRSEL ER LETTE Å NÅ.



[RETURN TO TOP OF THE PAGE](#)

---

## BSMI Notice (Taiwan Only)

符合乙類資訊產品之標準

[RETURN TO TOP OF THE PAGE](#)

---

## Ergonomie Hinweis (nur Deutschland)

Damit Ihr Monitor immer den in der Zulassung geforderten Werten entspricht, ist darauf zu achten, daß

1. Reparaturen nur durch Fachpersonal durchgeführt werden.
2. nur original-Ersatzteile verwendet werden.
3. bei Ersatz der Bildröhre nur eine bauartgleiche eingebaut wird.

Aus ergonomischen Gründen wird empfohlen, die Grundfarben Blau und Rot nicht auf dunklem Untergrund zu verwenden (schlechte Lesbarkeit und erhöhte Augenbelastung bei zu geringem Zeichenkontrast wären die Folge).

Der arbeitsplatzbezogene Schalldruckpegel nach DIN 45 635 beträgt 70dB (A) oder weniger.



**ACHTUNG: BEIM AUFSTELLEN DIESES GERÄTES DARAUF ACHTEN, DAß NETZSTECKER UND NETZKABELANSCHLUß LEICHT ZUGÄNGLICH SIND.**

[RETURN TO TOP OF THE PAGE](#)

---

## End-of-Life Disposal

Your new monitor contains materials that can be recycled and reused. Specialized companies can recycle

your product to increase the amount of reusable materials and to minimize the amount to be disposed of.

Please find out about the local regulations on how to dispose of your old monitor from your local Philips dealer.

**(For customers in Canada and U.S.A.)**

This product may contain lead and/or mercury. Dispose of in accordance to local-state and federal regulations.

For additional information on recycling contact [www.eia.org](http://www.eia.org) (Consumer Education Initiative)

[RETURN TO TOP OF THE PAGE](#)

**Information for UK only**

**WARNING - THIS APPLIANCE MUST BE EARTHED.**

**Important:**

This apparatus is supplied with an approved moulded 13A plug. To change a fuse in this type of plug proceed as follows:

1. Remove fuse cover and fuse.
2. Fit new fuse which should be a BS 1362 5A, A.S.T.A. or BSI approved type.
3. Refit the fuse cover.

If the fitted plug is not suitable for your socket outlets, it should be cut off and an appropriate 3-pin plug fitted in its place.

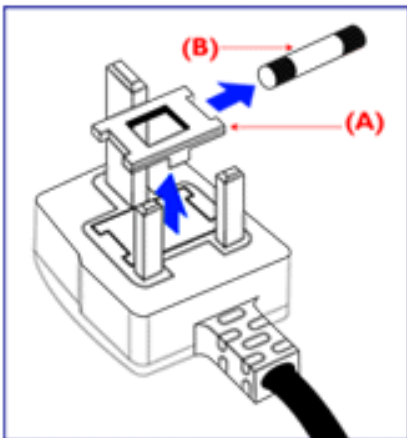

If the mains plug contains a fuse, this should have a value of 5A. If a plug without a fuse is used, the fuse at the distribution board should not be greater than 5A.

Note: The severed plug must be destroyed to avoid a possible shock hazard should it be inserted into a 13A socket elsewhere.

## How to connect a plug

The wires in the mains lead are coloured in accordance with the following code:

BLUE - "NEUTRAL" ("N")

BROWN - "LIVE" ("L")

GREEN & YELLOW - "EARTH" ("E")

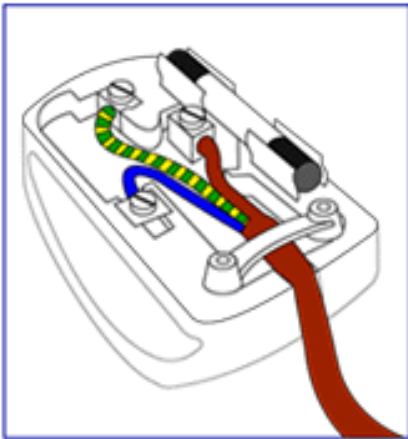

1. The GREEN AND YELLOW wire must be connected to the terminal in the plug which is marked with the letter "E" or by the Earth symbol  or coloured GREEN or GREEN AND YELLOW.

2. The BLUE wire must be connected to the terminal which is marked with the letter "N" or coloured BLACK.

3. The BROWN wire must be connected to the terminal which marked with the letter "L" or coloured RED.

Before replacing the plug cover, make certain that the cord grip is clamped over the sheath of the lead - not simply over the three wires.

[RETURN TO TOP OF THE PAGE](#)

---

## Waste Electrical and Electronic Equipment-WEEE

Attention users in European Union private households



This marking on the product or on its packaging illustrates that, under European Directive 2002/96/EG governing used electrical and electronic appliances, this product may not be disposed of with normal household waste. You are responsible for disposal of this equipment through a designated waste electrical and electronic equipment collection. To determine the locations for dropping off such waste electrical and electronic, contact your local government office, the waste disposal organization that serves your household or the store at which you purchased the product.

[RETURN TO TOP OF THE PAGE](#)

## Other Related Information

[Safety and Troubleshooting](#) • [FAQs](#) • [Troubleshooting](#) • [Regulatory Information](#) • [Information for Users in the U. S.](#) • [Information for Users Outside the U.S](#)

---

### Information for Users in the U. S.

*For units set at 115 V :*

Use a UL Listed Cord Set consisting of a minimum 18 AWG, Type SVT or SJT three conductor cord a maximum of 15-feet long and a parallel blade, grounding type attachment plug rated 15 A, 125 V.

*For units set at 230 V:*

Use a UL Listed Cord Set consisting of a minimum 18 AWG, Type SVT or SJT three conductor cord a maximum of 15-feet long and a tandem blade, grounding type attachment plug rated 15 A, 250 V.

---

### Information for Users outside the U.S.

*For units set at 230 V:*

Use a Cord Set consisting of a minimum 18 AWG cord and grounding type attachment plug rated 15 A, 250 V. The Cord Set should have the appropriate safety approvals for the country in which the equipment will be installed and / or be marked HAR.

[RETURN TO TOP OF THE PAGE](#)

# Philips Pixel Defect Policy

[Product Features](#) • [Technical Specifications](#) • [Resolution and Preset Modes](#) • [Automatic Power Saving](#) • [Physical Specification](#) • [Pin Assignment](#) • [Product Views](#)

---

## Philips' LCD Panel Pixel Defect Policy

Philips strives to deliver the highest quality products. We use some of the industry's most advanced manufacturing processes and practise stringent quality control. However, pixel or sub pixel defects on the TFT LCD panels used in flat panel monitors are sometimes unavoidable. No manufacturer can guarantee that all panels will be free from pixel defects, but Philips guarantees that any monitor with an unacceptable number of defects will be repaired or replaced under warranty. This notice explains the different types of pixel defects and defines acceptable defect levels for each type. In order to qualify for repair or replacement under warranty, the number of pixel defects on a TFT LCD panel must exceed these acceptable levels. For example, no more than 0.0004% of the sub pixels on a 32" XGA monitor may be defective. Furthermore, Philips sets even higher quality standards for certain types or combinations of pixel defects that are more noticeable than others. This policy is valid worldwide.

### Pixels and Sub pixels

A pixel, or picture element, is composed of three sub pixels in the primary colors of red, green and blue. Many pixels together form an image. When all sub pixels of a pixel are lit, the three colored subpixels together appear as a single white pixel. When all are dark, the three colored sub pixels together appear as a single black pixel. Other combinations of lit and dark sub pixels appear as single pixels of other colors.

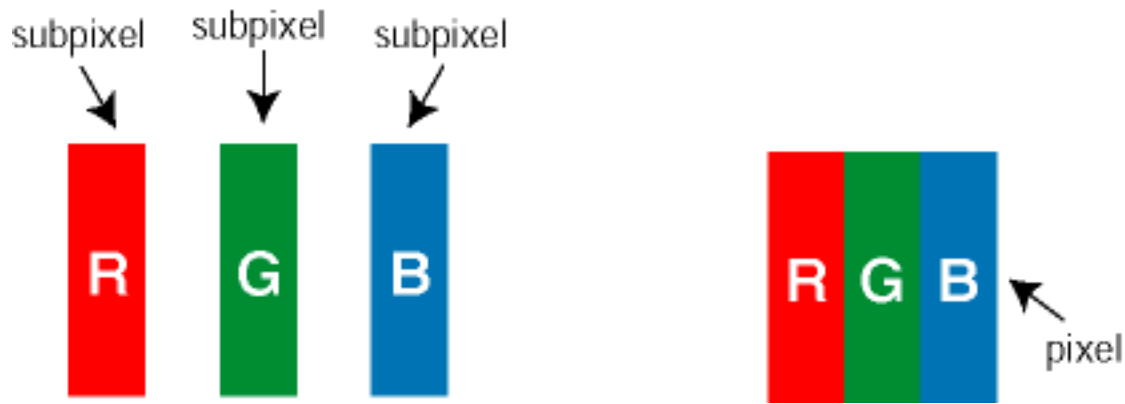

## Types of Pixel Defects

Pixel and sub pixel defects appear on the screen in different ways. There are two categories of pixel defects and several types of sub pixel defects within each category.

**Bright Dot Defects** Bright dot defects appear as pixels or sub pixels that are always lit or 'on'. That is, a *bright dot* is a sub-pixel that stands out on the screen when the monitor displays a dark pattern. There are the types of bright dot defects:

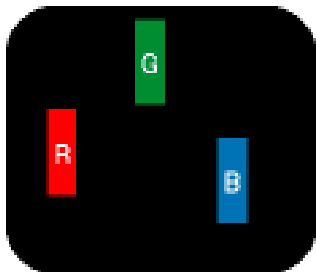

One lit red, green or blue sub pixel

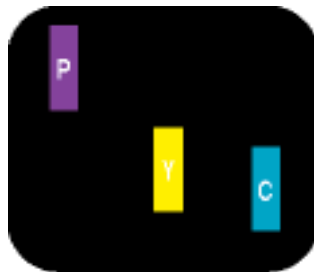

Two adjacent lit sub pixels:

- Red + Blue = Purple
- Red + Green = Yellow
- Green + Blue = Cyan (Light Blue)



Three adjacent lit sub pixels (one white pixel)



A red or blue *bright dot* must be more than 50 percent brighter than neighboring dots while a green bright dot is 30 percent brighter than neighboring dots.

**Black Dot Defects** Black dot defects appear as pixels or sub pixels that are always dark or 'off'. That is, a *dark dot* is a sub-pixel that stands out on the screen when the monitor displays a light pattern. These are the types of black dot defects:

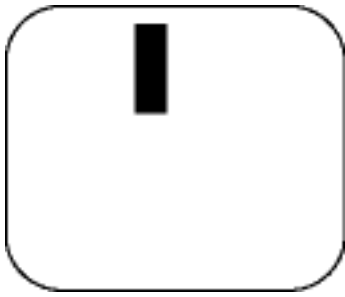

One dark sub pixel

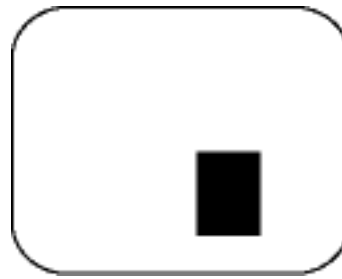

Two or three adjacent dark sub pixels

## Proximity of Pixel Defects

Because pixel and sub pixels defects of the same type that are near to one another may be more noticeable, Philips also specifies tolerances for the proximity of pixel defects.

## Pixel Defect Tolerances

In order to qualify for repair or replacement due to pixel defects during the warranty period, a TFT LCD panel in a Philips flat panel monitor must have pixel or sub pixel defects exceeding the tolerances listed in the following tables.

<b>BRIGHT DOT DEFECTS</b>	<b>ACCEPTABLE LEVEL</b>
<i>MODEL</i>	<b>BDL3221V</b>
1 lit sub pixel	0
2 adjacent lit sub pixels	0
3 adjacent lit sub pixels (one white pixel)	0
75% ~ 50% of Dot	0
50% ~ Less Dot (Weak Dot)	Max 7
Distance between two bright dot defects*	N/A
Total bright dot defects of all types	0



Tiny bright dots less then 50% R/B, 30% G	Max 4
---	-------

\* Bright Dot is defined as dots (sub-pixels) which appeared brightly in the screen when the LCM displayed with whole pattern & Bright Dot's brightness is defined over 50% of the brightness against around. (but, Green bright dot is over 30% of brightness against around)

\* Here in Tiny Bright Dot is defined as "for Red and Blue" the bright area should be no longer than 1/2 sub-pixel and for green the bright area should be no larger than 1/3 sub-pixel.

<b>BLACK DOT DEFECTS</b>	<b>ACCEPTABLE LEVEL</b>
<i>MODEL</i>	<b>BDL3221V</b>
1 dark sub pixel	5 or fewer
2 adjacent dark sub pixels	1 or fewer
3 adjacent dark sub pixels	0
Distance between two black dot defects*	15 mm or more
Total black dot defects of all types	5 or fewer

<b>TOTAL DOT DEFECTS</b>	<b>ACCEPTABLE LEVEL</b>
<i>MODEL</i>	<b>BDL3221V</b>
Total bright or black dot defects of all types	5 or fewer

*Note:*

\* 1 or 2 adjacent sub pixel defects = 1 dot defect

*All Philips monitors are ISO13406-2 Compliant*

[RETURN TO TOP OF THE PAGE](#)

## Connecting to Your PC, TV Antenna, DVD/VCR etc.

[Product Description](#) • [Accessory Pack](#) • [Connecting to Your PC, TV Antenna, DVD/VCR etc.](#) • [Getting Started](#) • [Optimizing Performance](#)

---

### Accessory Pack

Unpack all the parts

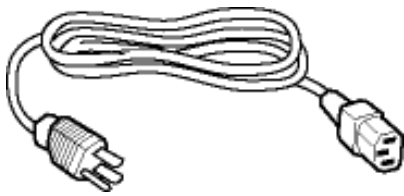

Power cable

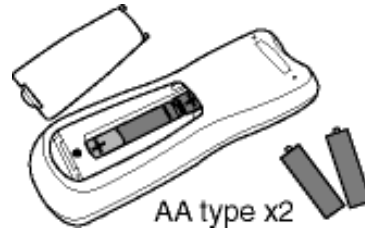

Remote control & batteries



DVI-D cable

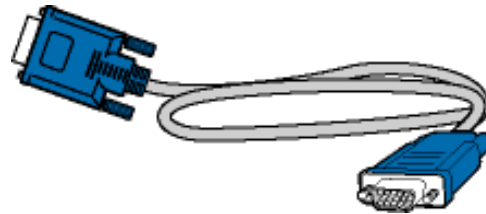

VGA signal cable



E-DFU pack

Accessories below are available for TV model only



Base

Screw pack



2x10 W Detachable Speakers

[RETURN TO TOP OF THE PAGE](#)

## Setting up and connecting your monitor/TV



**CAUTION:** Ensure that the power to the monitor/TV is switched off before the installation.

### - Connecting the monitor/TV

- Connect the cables to the rear of your monitor/TV according to the numbers:

### TV model

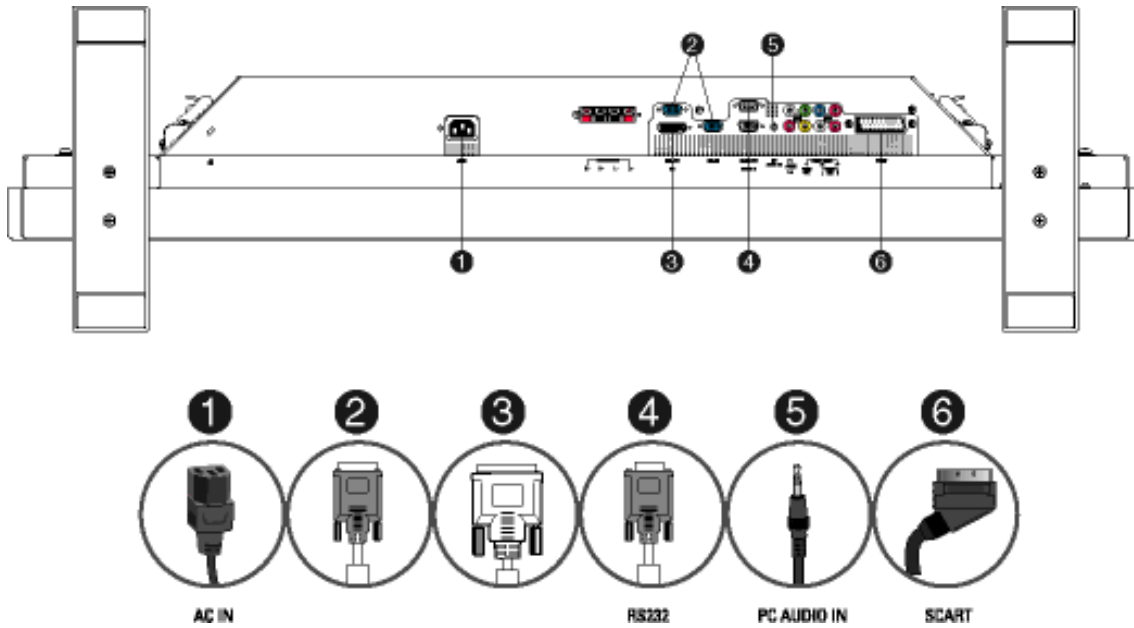

[RETURN TO TOP OF THE PAGE](#)

## - Connect to PC

- Connect the cables to the back of your computer by following step 1~5.
- If your monitor displays the computer image the installation has been completed successfully.
- If installation was not successful, see the [Troubleshooting](#) section.
- For installation of the monitor driver for Microsoft Windows®, see the Monitor Driver Installation section ([Getting Started](#)).

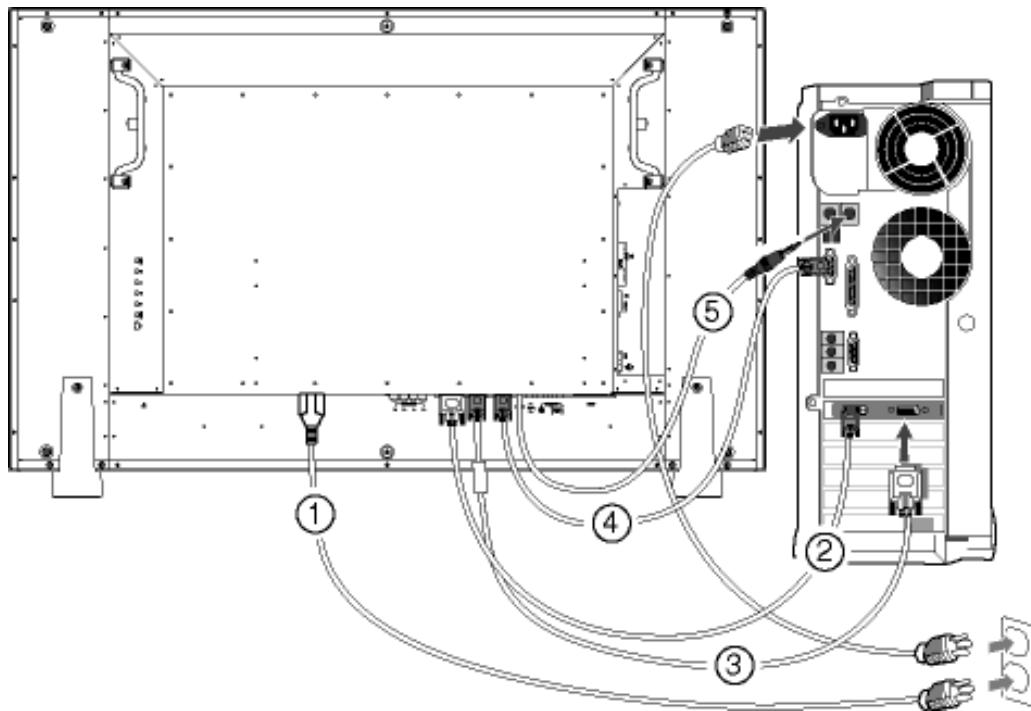

[RETURN TO TOP OF THE PAGE](#)

## - Connect to DVD/VCD/VCR

### Connect to DVD/VCR/VCD through S-VIDEO

- Connect to DVD/VCR/VCD through S-VIDEO

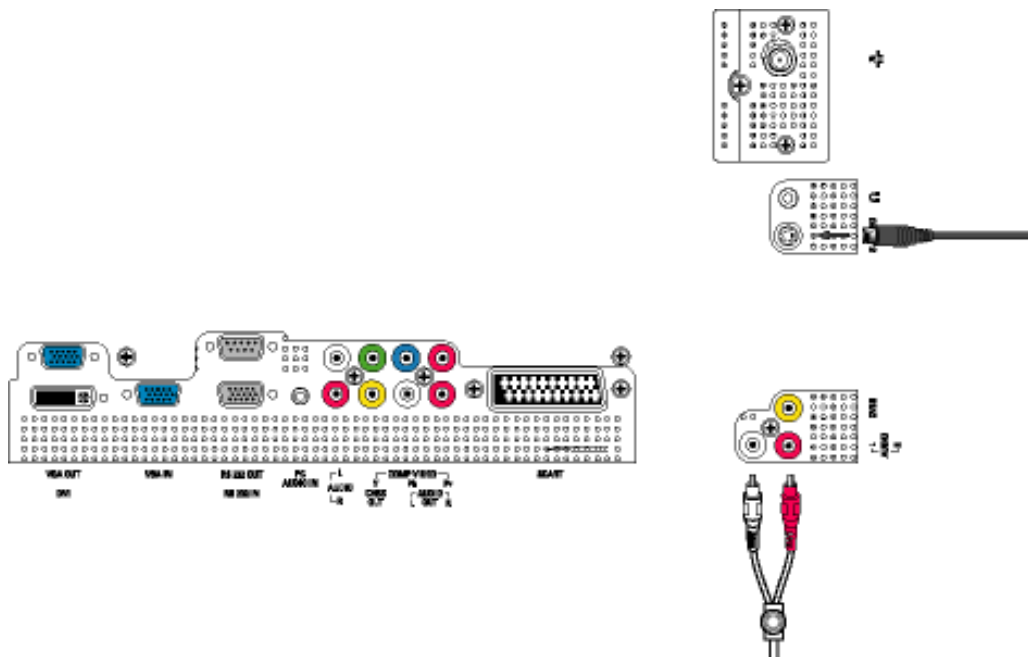

- Connect to DVD/VCR /VCD through SCART (for Europe only)

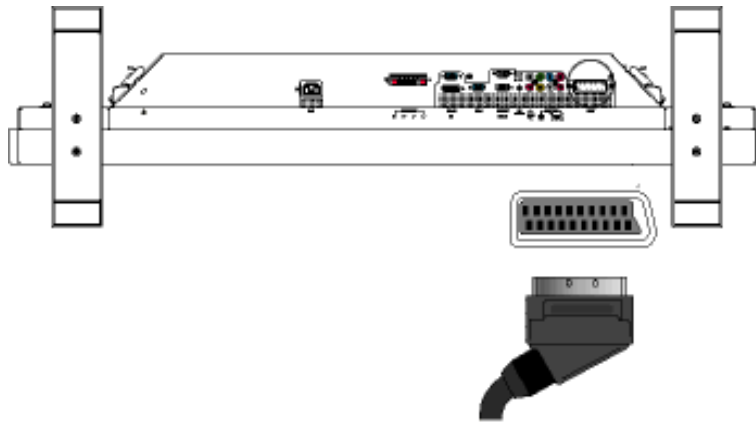

- Connect to DVD/VCR /VCD through composite video (CVBS)

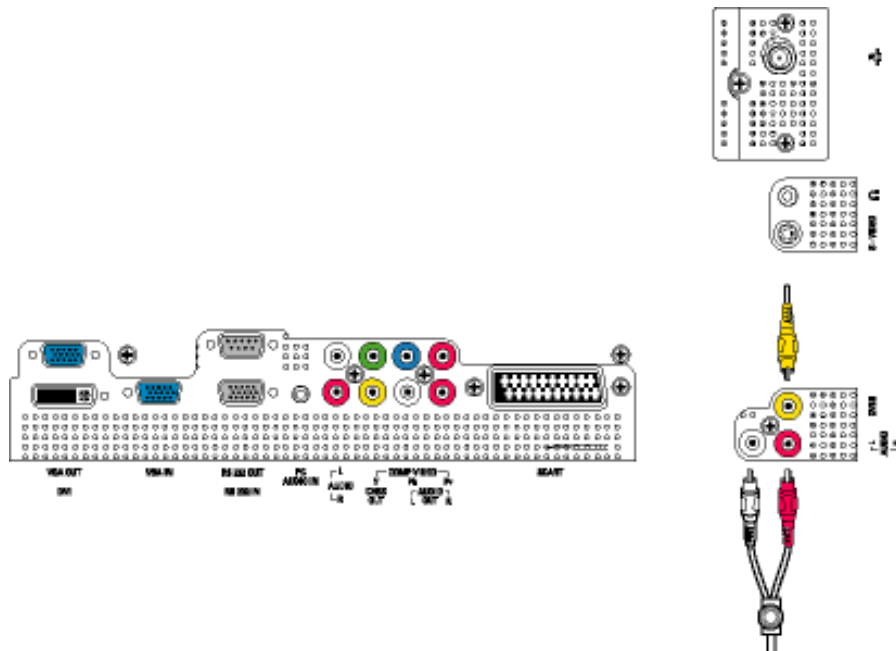

- Connect to DVD/VCR /VCD through component video (YPbPr)

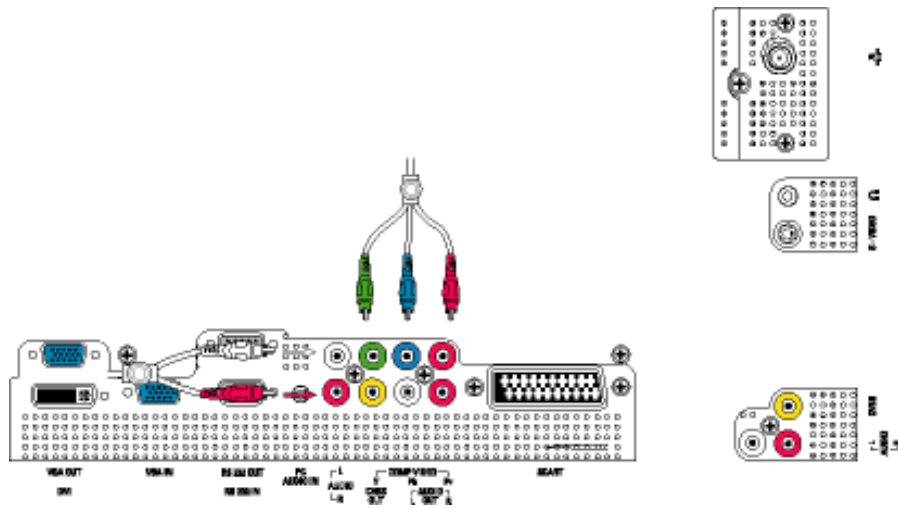

[RETURN TO TOP OF THE PAGE](#)

## Connecting to Cable TV

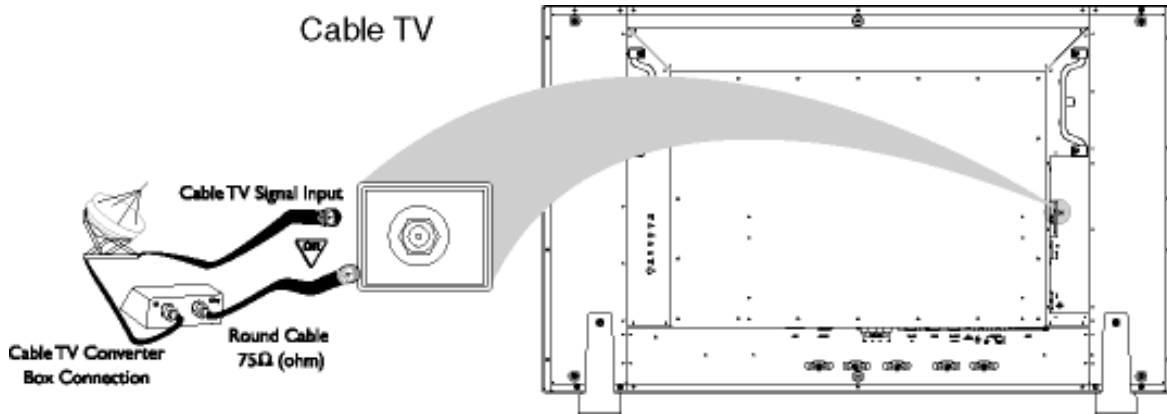

## Antenna

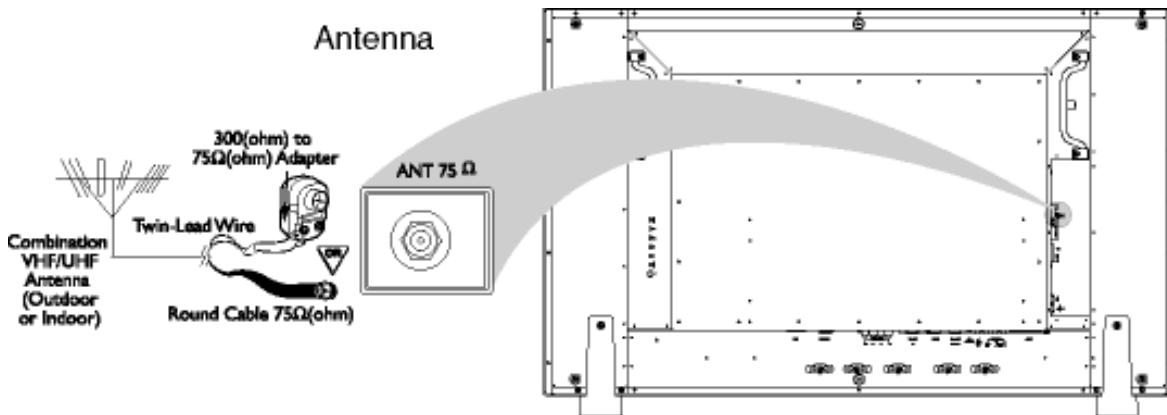

### Monitor TV to VCR/ DVD

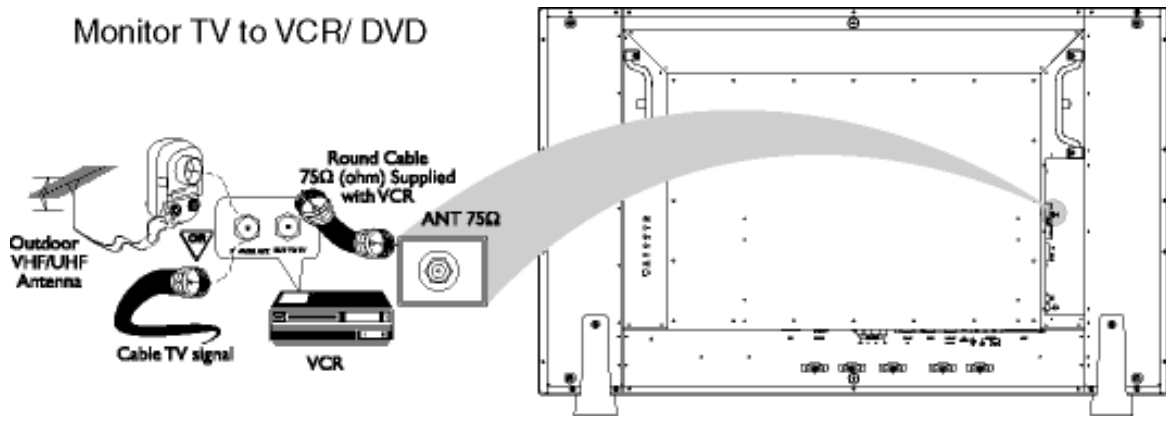

### Progressive video and HDTV connections for digital high-definition picture

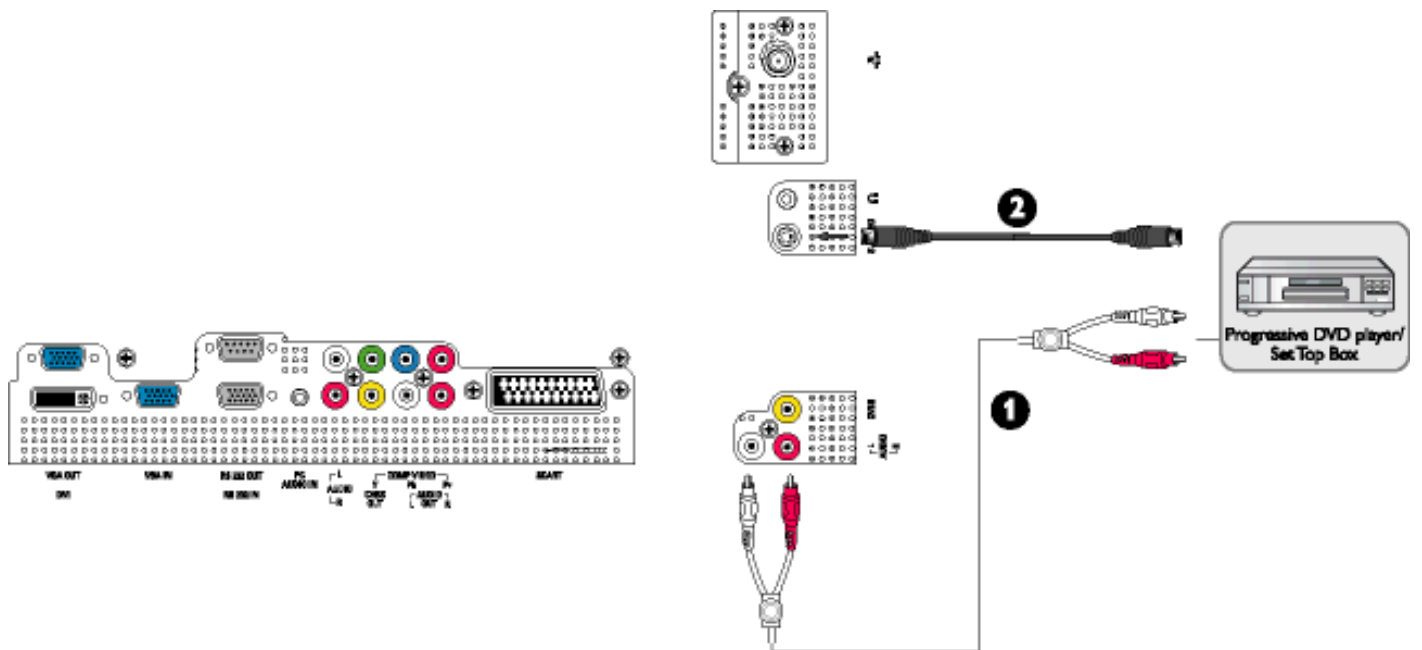
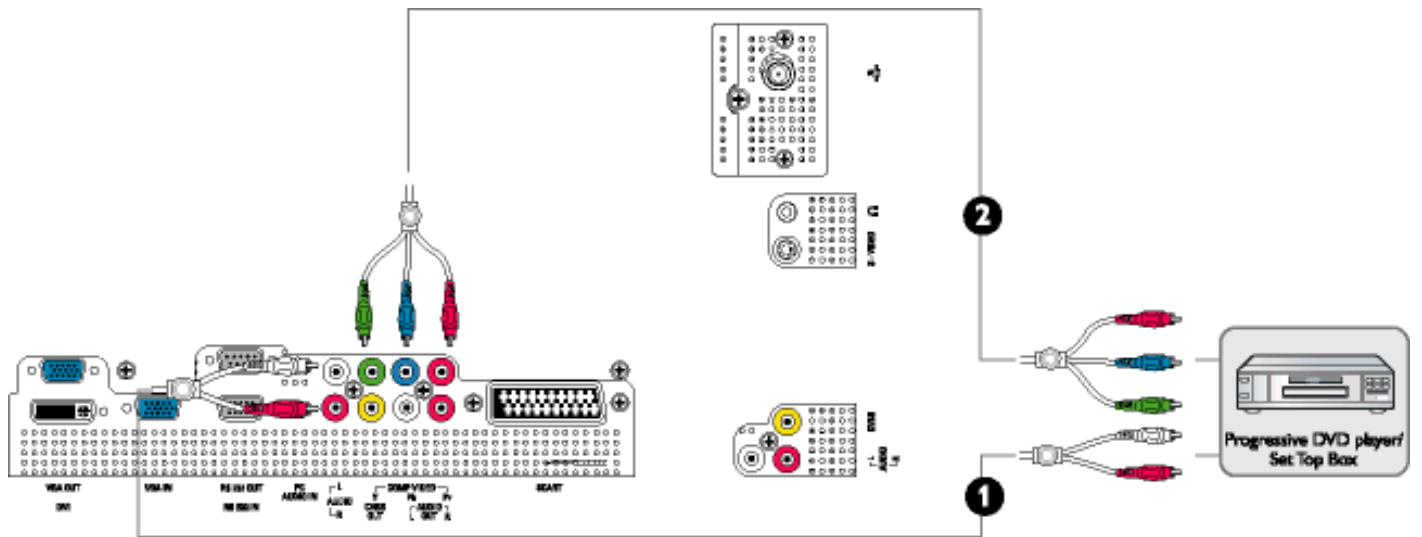



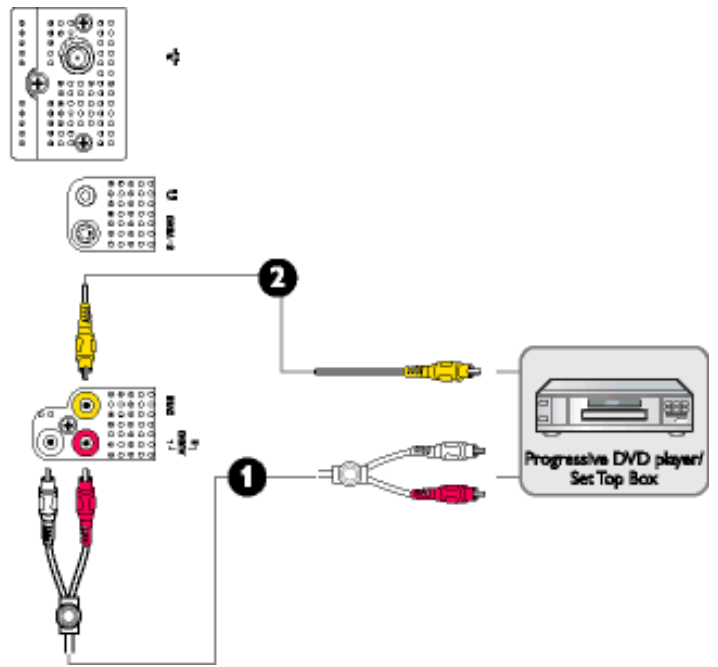
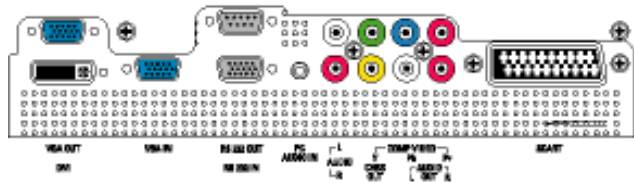

[RETURN TO TOP OF THE PAGE](#)

# Getting Started

[Product Description](#) • [Connecting to Your PC, TV Antenna, DVD/VCR etc.](#) • [Driver Installation](#) • [Optimizing Performance](#)

---

## Driver Installation

### Use the information file ( .inf) for Windows® 95/98/2000/Me/XP or later

The built-in VESA DDC2B feature in Philips Monitors supports Plug & Play requirements for Windows® 95/98/2000/Me/XP. This information file ( .inf) should be installed in order that your Philips monitor can be enabled from the 'Monitor' dialog box in Windows® 95/98/2000/Me/XP and the Plug & Play application can be activated. The installation procedure based on Windows® '95 OEM Release 2 , 98 , Me, XP and 2000 is specified as follows.

#### For Windows® 95

1. Start Windows® '95
2. Click on the 'Start' button, point to 'Settings', and then click on 'Control Panel'.
3. Double click on the 'Display' Icon.
4. Select the 'Settings' tab then click on 'Advanced...'
5. Select the 'Monitor' button, point to 'Change...' then click on 'Have Disk...'
6. Click on the 'Browse...' button, select the appropriate drive F: ( CD-ROM Drive) then click on the 'OK' button.
7. Click on the 'OK' button then select your monitor model and click on the 'OK'.
8. Click on the 'Close' button.

#### For Windows® 98

1. Start Windows® 98
2. Click on the 'Start' button, point to 'Settings', and then click on 'Control Panel'.
3. Double click on the 'Display' Icon.
4. Select the 'Settings' tab then click on 'Advanced...'
5. Select the 'Monitor' button, point to 'Change...' then click on 'Next'
6. Select 'Display a list of all the drivers in a specific location, so you can choose the driver you want.' then click on 'Next' and then click on 'Have Disk...'
7. Click on the 'Browse...' button, select the appropriate drive F: ( CD-ROM Drive) then click on the 'OK' button.
8. Click on the 'OK' button then select your monitor model and click on the 'Next' button.
9. Click on the 'Finish' button then the 'Close' button.

## For Windows® Me

1. Start Windows® Me
2. Click on the 'Start' button, point to 'Settings', and then click on 'Control Panel'.
3. Double click on the 'Display' Icon.
4. Select the 'Settings' tab then click on 'Advanced...'
5. Select 'Monitor' button, then click on 'Change...' button.
6. Select 'Specify the location of the driver(Advanced)' and click on the 'Next' button.
7. Select 'Display a list of all the drivers in a specific location, so you can choose the driver you want', then click on 'Next' and then click on 'Have Disk...'
8. Click on 'Browse...' button, select the appropriate drive F: ( CD-ROM Drive) then click on the 'OK' button.
9. Click on the 'OK' button, select your monitor model and click on the 'Next' button.
10. Click on 'Finish' button then the 'Close' button.

## For Windows® 2000

1. Start Windows® 2000
2. Click on the 'Start' button, point to 'Settings', and then click on 'Control Panel'.
3. Double click on the 'Display' Icon.
4. Select the 'Settings' tab then click on 'Advanced...'
5. Select 'Monitor'
  - If the 'Properties' button is inactive, it means your monitor is properly configured. Please stop installation.
  - If the 'Properties' button is active. Click on 'Properties' button. Please follow the steps given below.
6. Click on 'Driver' and then click on 'Update Driver...' then click on the 'Next' button.
7. Select 'Display a list of the known drivers for this device so that I can choose a specific driver', then click on 'Next' and then click on 'Have disk...'
8. Click on 'Browse...' button then select the appropriate drive F: ( CD-ROM Drive).
9. Click on the 'Open' button, then click on the 'OK' button.
10. Select your monitor model and click on the 'Next' button.
11. Click on the 'Finish' button then the 'Close' button.
  - If you can see the 'Digital Signature Not Found' window, click on the 'Yes' button.

## For Windows® XP

1. Start Windows® XP
2. Click on the 'Start' button and then click on 'Control Panel'.
3. Select and click on the category 'Printers and Other Hardware'
4. Click on the 'Display' Icon.
5. Select the 'Settings' tab then click on the 'Advanced' button.
6. Select 'Monitor' tab
  - If the 'Properties' button is inactive, it means your monitor is properly configured. Please stop installation.

- If the 'Properties' button is active, click on 'Properties' button.

Please follow the steps below.

7. Click on the 'Driver' tab and then click on 'Update Driver...' button.
8. Select the 'Install from a list or specific location [advanced]' radio button and then click on the 'Next' button.
9. Select the 'Don't Search. I will choose the driver to install' radio button. Then click on the 'Next' button.
10. Click on the 'Have disk...' button, then click on the 'Browse...' button and then select the appropriate drive F: (CD-ROM Drive).
11. Click on the 'Open' button, then click the 'OK' button.
12. Select your monitor model and click on the 'Next' button.
  - If you can see the 'has not passed Windows® Logo testing to verify its compatibility with Windows® XP' message please click on the 'Continue Anyway' button.
13. Click on the 'Finish' button then the 'Close' button.
14. Click on the 'OK' button and then the 'OK' button again to close the Display\_Properties dialog box.

If your Windows® 95/98/2000/Me/XP version is different or you need more detailed installation information, please refer to Windows® 95/98/2000/Me/XP user's manual.

[RETURN TO TOP OF THE PAGE](#)

## Your Philips F1rst Choice Warranty

**Thank you for purchasing this Philips monitor.**



All Philips monitors are designed and manufactured to high standards and deliver high-quality performance, ease of use and ease of installation. Should you encounter any difficulties while installing or using this product, please contact the Philips helpdesk directly to benefit from your Philips F1rst Choice Warranty. This three-year service warranty entitles you to a swap model on-site if your monitor turns out to be faulty or defective. Philips aims at a swap within 48 hours of your call being received.

### What is covered?

The Philips F1rst Choice Warranty applies within Andorra, Austria, Belgium, Cyprus, Denmark, France, Germany, Greece, Finland, Ireland, Italy, Liechtenstein, Luxembourg, Monaco, the Netherlands, Norway, Portugal, Sweden, Switzerland, Spain and the United Kingdom and only for monitors originally designed, manufactured, approved and/or authorized for usage within these countries.

Warranty coverage begins as from the day you buy your monitor. *For three years thereafter*, your monitor will be swapped by at least an equivalent monitor in case of defects provided for under the warranty coverage.

The swap monitor remains yours and Philips keeps the defective/original monitor. For the swap monitor the warranty period remains equal to that of your original monitor, being 36 months as from the purchase date of your original monitor.

### What is excluded?

The Philips F1rst Choice Warranty applies provided the product is handled properly for its intended use, in accordance with its operating instructions and upon presentation of the original invoice or cash receipt, indicating the date of purchase, dealer's name and model and production number of the product.

The Philips F1rst Choice Warranty may not apply if:

- The documents have been altered in any way or made illegible;
- The model or production number on the product has been altered, deleted, removed or made illegible;
- Repairs or product modifications and alterations have been executed by unauthorized service organizations or persons;

- Damage is caused by accidents including but not limited to lightning, water or fire, misuse or neglect;
- Reception problems caused by signal conditions or cable or antenna systems outside the unit;
- Defects caused by abuse or misuse of the monitor;
- Product requires modification or adaptation to enable it to comply with local or national technical standards, which apply in countries for which the product was not originally designed, manufactured, approved and/or authorized. Therefore always check whether a product can be used in a specific country.
- Note that products that are not originally designed, manufactured, approved and/or authorized for usage within the Philips F1rst Choice countries, do not apply to the Philips F1rst Choice Warranty. In these cases the Philips global warranty terms are valid.

### Just a click away

In case of any problems, we advise you to read the operating instructions carefully or go to the [www.philips.com/support](http://www.philips.com/support) website for additional support.

### Just a phone call away

In order to avoid unnecessary inconvenience, we advise you to read the operating instructions carefully or go to the [www.philips.com/support](http://www.philips.com/support) website for additional support before contacting the Philips helpdesk.

To solve your problem quickly, please prepare the following details before contacting the Philips helpdesk:

- Philips type number
- Philips serial number
- Purchase date (copy of purchase may be required)
- PC environment Processor:
  - 286/386/486/Pentium Pro/Internal memory
  - Operating system (Windows, DOS, OS/2, MAC)
  - Fax/Modem/Internet program?
- Other cards installed

Having the following information available will also help speed up the process:

- Your proof of purchase indicating: date of purchase, dealer name, model and product serial number.
- The full address to which the faulty monitor has to be collected and the swap model should be delivered.

Philips' customer help desks are located worldwide. Click here to access the [F1rst Choice Contact](#)

[Information.](#)

Or you can reach us via:

Website: <http://www.philips.com/support>

## Your International Guarantee

Dear Customer,

Thank you for purchasing this Philips product which has been designed and manufactured to the highest quality standards.

If, unfortunately, something should go wrong with this product Philips guarantees free of charge labor and replacement parts irrespective of the country where it is repaired during a period of 12 months from date of purchase. This international Philips guarantee complements the existing national guarantee obligations to you of dealers and Philips in the country of purchase and does not affect your statutory rights as a customer.

The Philips guarantee applies provided the product is handled properly for its intended use, in accordance with its operating instructions and upon presentation of the original invoice or cash receipt, indicating the date of purchase, dealer's name and model and production number of the product.

The Philips guarantee may not apply if:

- the documents have been altered in any way or made illegible;
- the model or production number on the product has been altered, deleted, removed or made illegible;
- repairs or product modifications and alterations have been executed by unauthorized service organizations or persons;
- damage is caused by accidents including but not limited to lightning, water or fire, misuse or neglect.

Please note that the product is not defective under this guarantee in the case where modifications become necessary in order for the product to comply with local or national technical standards which apply in countries for which the product was not originally designed and/or manufactured. Therefore always check whether a product can be used in a specific country.

In case your Philips product is not working correctly or is defective, please contact your Philips dealer. In the event you require service whilst in another country a dealer address can be given to you by the Philips Consumer Help Desk in that country, the telephone and fax number of which can be found in the relevant part of this booklet.

In order to avoid unnecessary inconvenience, we advise you to read the operating instructions carefully before contacting your dealer. If you have questions which your dealer cannot answer or any related question please contact the [Philips Consumer Information Centers](#) or via:

Website: <http://www.philips.com>



## PHILIPS LIMITED WARRANTY

### One (1) Year Labor and Parts Repair

**PHILIPS CONSUMER ELECTRONICS** warrants this product against defect in material or workmanship, subject to any conditions set forth as follows:

#### PROOF OF PURCHASE:

You must have proof of the date of purchase to receive warranted repair on the product. A sales receipt or other document showing the product and the date that you purchased the products as well as the authorized retailer included, is considered such proof.

#### COVERAGE:

(If this product is determined to be defective)

**LABOR:** For a period of one (1) year from the date of purchase, Philips will repair or replace the product, at its option, at no charge, or pay the labor charges to any Philips authorized repair facility. After the period of one (1) year, Philips will no longer be responsible for charges incurred.

**PARTS:** For a period of one (1) year from the date of purchase, Philips will supply, at no charge, new or rebuilt replacement parts in exchange for defective parts, through a Philips authorized service center.

Note: If Philips is unable to provide service in your area, receipt of the paid service can be submitted for consideration of adjustment or full reimbursement at Philips discretion.

#### EXCLUDED FROM WARRANTY COVERAGE

Your warranty does not cover:

- Labor charges for installation or setup of the product, adjustment of customer controls on the product, and installation or repair of antenna systems outside of the product.
- Product repair and/or part replacement because of improper installation, connections to improper voltage supply, abuse, neglect, misuse, accident, unauthorized repair or other cause not within the control of Philips.
- A product that requires modification or adaptation to enable it to operate in any country other than the country for which it was designed, manufactured, approved and/or authorized, or repair of products damaged by these modifications.
- Damage occurring to product during shipping when improperly packaged or cost associated with packaging.
- Product lost in shipment and no signature verification of receipt can be provided.
- Products sold AS IS or RENEWED.

#### CARRY-IN / SHIP-IN WARRANTY

For Carry-In warranty repair, take the product to a Philips authorized service center for repair. When the product has been repaired, you must pick up the unit at the center. For Ship-In warranty repair, ship the product to a Philips authorized service center for repair in its original carton and packing material. If you do not have the original carton or packing material, have your product professionally packed for shipping. Ship product via a traceable carrier. When it is necessary for you to ship the product to Philips for repair, you will pay the shipping cost for shipment to Philips. Philips will pay the shipping costs when returning the product to you.

#### TO OBTAIN WARRANTY SERVICE IN THE U.S.A., PUERTO RICO, OR U.S. VIRGIN ISLANDS...

Contact Philips Customer Care Center at:  
[1-888-PHILIPS \(1-888-744-5477\)](tel:1-888-PHILIPS)

#### TO OBTAIN WARRANTY SERVICE IN CANADA...

[1-800-661-6162](tel:1-800-661-6162) (French Speaking)  
[1-888-PHILIPS \(1-888-744-5477\)](tel:1-888-PHILIPS) - (English or Spanish Speaking)

REPAIR OR REPLACEMENT AS PROVIDED UNDER THIS WARRANTY IS THE EXCLUSIVE REMEDY FOR THE CONSUMER. PHILIPS SHALL NOT BE LIABLE FOR ANY INCIDENTAL OR CONSEQUENTIAL DAMAGES FOR BREACH OF ANY EXPRESS OR IMPLIED WARRANTY ON THIS PRODUCT. EXCEPT TO THE EXTENT PROHIBITED BY APPLICABLE LAW, ANY IMPLIED WARRANTY OF MERCHANTABILITY OR FITNESS FOR A PARTICULAR PURPOSE ON THIS PRODUCT IS LIMITED IN DURATION TO THE DURATION OF THIS WARRANTY.

Some states do not allow the exclusions or limitation of incidental or consequential damages, or allow limitations on how long an implied warranty lasts, so the above limitations or exclusions may not apply to you. In addition, if you enter into a service contract agreement with the PHILIPS partnership within ninety (90) days of the date of sale, the limitation on how long an implied warranty lasts does not apply.

*This warranty gives you specific legal rights. You may have other rights which vary from state/province to state/province.*

**Philips, P.O. Box 671539, Marietta, GA. 30006-0026**

*(Warranty: 4835 710 27175)*

# F1rst Choice Contact Information

Country	Telephone number	Tariff
Austria	0820 901115	€ 0.20
Belgium	070 253 010	€ 0.17
Cyprus	800 92256	Free of Charge
Denmark	3525 8761	Local call tariff
Finland	09 2290 1908	Local call tariff
France	08 9165 0006	€ 0.23
Germany	0180 5 007 532	€ 0.12
Greece	00800 3122 1223	Local call tariff
Ireland	01 601 1161	Local call tariff
Italy	199 404 042	€ 0.25
Luxembourg	26 84 30 00	Local call tariff
The Netherlands	0900 0400 063	€ 0.20
Norway	2270 8250	Local call tariff
Portugal	2 1359 1440	Local call tariff
Spain	902 888 785	€ 0.15
Sweden	08 632 0016	Local call tariff
Switzerland	02 2310 2116	Local call tariff
United Kingdom	0207 949 0069	Local call tariff

## Consumer Information Centers

[Antilles](#) • [Argentina](#) • [Australia](#) • [Bangladesh](#) • [Brasil](#) • [Canada](#) • [Chile](#) • [China](#) • [Colombia](#) • [Belarus](#) • [Bulgaria](#) • [Croatia](#) • [Czech Republic](#) • [Estonia](#) • [Dubai](#) • [Hong Kong](#) • [Hungary](#) • [India](#) • [Indonesia](#) • [Korea](#) • [Latvia](#) • [Lithuania](#) • [Malaysia](#) • [Mexico](#) • [Morocco](#) • [New Zealand](#) • [Pakistan](#) • [Paraguay](#) • [Peru](#) • [Philippines](#) • [Poland](#) • [Romania](#) • [Russia](#) • [Serbia & Montenegro](#) • [Singapore](#) • [Slovakia](#) • [Slovenia](#) • [South Africa](#) • [Taiwan](#) • [Thailand](#) • [Turkey](#) • [Ukraine](#) • [Uruguay](#) • [Venezuela](#)

### Eastern Europe

#### BELARUS

Technical Center of JV IBA  
M. Bogdanovich str. 155  
BY - 220040 Minsk  
Tel: +375 17 217 33 86

#### BULGARIA

LAN Service  
140, Mimi Balkanska Str.  
Office center Translog  
1540 Sofia, Bulgaria  
Tel: +359 2 960 2360  
[www.lan-service.bg](http://www.lan-service.bg)

#### CZECH REPUBLIC

Xpectrum  
Lužná 591/4  
CZ - 160 00 Praha 6 Tel: 800 100 697  
Email:[info@xpectrum.cz](mailto:info@xpectrum.cz)  
[www.xpectrum.cz](http://www.xpectrum.cz)

## CROATIA

Renoprom d.o.o.  
Mlinska 5, Strmec  
HR - 41430 Samobor  
Tel: +385 1 333 0974

## ESTONIA

FUJITSU SERVICES OU  
Akadeemia tee 21G  
EE-12618 Tallinn  
Tel: +372 6519900  
[www.ee.invia.fujitsu.com](http://www.ee.invia.fujitsu.com)

## HUNGARY

Serware Szerviz  
Vizimolnár u. 2-4  
HU - 1031 Budapest  
Tel: +36 1 2426331  
Email: [inbox@serware.hu](mailto:inbox@serware.hu)  
[www.serware.hu](http://www.serware.hu)

## LATVIA

ServiceNet LV  
Jelgavas iela 36  
LV - 1055 Riga,  
Tel: +371 7460399  
Email: [serviss@servicenet.lv](mailto:serviss@servicenet.lv)

## LITHUANIA

ServiceNet LT  
Gaiziunu G. 3  
LT - 3009 KAUNAS  
Tel: +370 7400088  
Email: [servisas@servicenet.lt](mailto:servisas@servicenet.lt)  
[www.servicenet.lt](http://www.servicenet.lt)

## ROMANIA

Blue Ridge Int'l Computers SRL  
115, Mihai Eminescu St., Sector 2  
RO - 020074 Bucharest  
Tel: +40 21 2101969

## SERBIA & MONTENEGRO

Tehnicom Service d.o.o.  
Bulevar Vojvode Misica 37B  
YU - 11000 Belgrade  
Tel: +381 11 3060 886

## SLOVAKIA

Datalan Servisne Stredisko  
Puchovska 8  
SK - 831 06 Bratislava  
Tel: +421 2 49207155  
Email: servis@datalan.sk

## SLOVENIA

PC HAND  
Brezovce 10  
SI - 1236 Trzin  
Tel: +386 1 530 08 24  
Email: servis@pchand.si

## POLAND

Zolter  
ul.Zytania 1  
PL - 05-500 Piaseczno  
Tel: +48 22 7501766  
Email: servmonitor@zolter.com.pl  
www.zolter.com.pl

## RUSSIA

Tel: +7 095 961-1111  
Tel: 8-800-200-0880  
Website: www.philips.ru

## TURKEY

Türk Philips Ticaret A.S.  
Yukari Dudullu Org.San.Bolgesi  
2.Cadde No:22  
34776-Umraniye/Istanbul  
Tel: (0800)-261 33 02

## UKRAINE

Comel  
Shevchenko street 32  
UA - 49030 Dnepropetrovsk  
Tel: +380 562320045  
www.csp-comel.com

## Latin America

### ANTILLES

Philips Antillana N.V.  
Kaminda A.J.E. Kusters 4  
Zeelandia, P.O. box 3523-3051  
Willemstad, Curacao  
Phone: (09)-4612799  
Fax : (09)-4612772

### ARGENTINA

Philips Antillana N.V.  
Vedia 3892 Capital Federal  
CP: 1430 Buenos Aires  
Phone/Fax: (011)-4544 2047

### BRASIL

Philips da Amazônia Ind. Elet. Ltda.  
Rua Verbo Divino, 1400-São Paulo-SP  
CEP-04719-002  
Phones: 11 21210203 -São Paulo & 0800-701-0203-Other Regions without São Paulo City

## CHILE

Philips Chilena S.A.  
Avenida Santa Maria 0760  
P.O. box 2687 Santiago de Chile  
Phone: (02)-730 2000  
Fax : (02)-777 6730

## COLOMBIA

Industrias Philips de Colombia  
S.A.-Division de Servicio  
CARRERA 15 Nr. 104-33  
Bogota, Colombia  
Phone:(01)-8000 111001 (toll free)  
Fax : (01)-619-4300/619-4104

## MEXICO

Consumer Information Centre  
Norte 45 No.669  
Col. Industrial Vallejo  
C.P.02300, -Mexico, D.F.  
Phone: (05)-3687788 / 9180050462  
Fax : (05)-7284272

## PARAGUAY

Av. Rca. Argentina 1780 c/Alfredo Seiferheld  
P.O. Box 605  
Phone: (595 21) 664 333  
Fax: (595 21) 664 336  
Customer Desk:  
Phone: 009 800 54 1 0004

## PERU

Philips Peruana S.A.  
Customer Desk  
Comandante Espinar 719  
Casilla 1841  
Limab18  
Phone: (01)-2136200  
Fax : (01)-2136276

## URUGUAY

Rambla O'Higgins 5303 Montevideo  
Uruguay  
Phone: (598) 619 66 66  
Fax: (598) 619 77 77  
Customer Desk:  
Phone: 0004054176

## VENEZUELA

Industrias Venezolanas Philips S.A.  
Apartado Postal 1167  
Caracas 1010-A  
Phone: (02) 2377575  
Fax : (02) 2376420

## Canada

## CANADA

Philips Electronics Ltd.  
281 Hillmount Road  
Markham, Ontario L6C 2S3  
Phone: (800) 479-6696

## Pacific



## AUSTRALIA

Philips Consumer Electronics  
Consumer Care Center  
Level 1, 65 Epping Rd  
North Ryde NSW 2113  
Phone: 1300 363 391  
Fax : +61 2 9947 0063

## NEW ZEALAND

Philips New Zealand Ltd.  
Consumer Help Desk  
2 Wagener Place, Mt.Albert  
P.O. box 1041  
Auckland  
Phone: 0800 477 999 (toll free)  
Fax : 0800 288 588

## Asia

## BANGLADESH

Philips Service Centre  
100 Kazi Nazrul Islam  
Avenue Kawran Bazar C/A  
Dhaka-1215  
Phone: (02)-812909  
Fax : (02)-813062

## CHINA

SHANGHAI  
Rm 1007, Hongyun Building, No. 501 Wuning road,  
200063 Shanghai P.R. China  
Phone: 4008 800 008  
Fax: 21-52710058

## HONG KONG

Philips Electronics Hong Kong Limited  
Consumer Service  
Unit A, 10/F. Park Sun Building  
103-107 Wo Yi Hop Road  
Kwai Chung, N.T.  
Hong Kong  
Phone: (852)26199663  
Fax: (852)24815847

## INDIA

Phone: 91-20-712 2048 ext: 2765  
Fax: 91-20-712 1558

### BOMBAY

Philips India  
Customer Relation Centre  
Bandbox House  
254-D Dr. A Besant Road, Worli  
Bombay 400 025

### CALCUTTA

Customer Relation Centre  
7 justice Chandra Madhab Road  
Calcutta 700 020

### MADRAS

Customer Relation Centre  
3, Haddows Road  
Madras 600 006

### NEW DELHI

Customer Relation Centre  
68, Shivaji Marg  
New Dehli 110 015

## INDONESIA

Philips Group of Companies in Indonesia  
Consumer Information Centre  
Jl.Buncit Raya Kav. 99-100  
12510 Jakarta  
Phone: (021)-7940040 ext: 2100  
Fax : (021)-794 7511 / 794 7539

## KOREA

Philips Korea Ltd.  
Philips House  
C.P.O. box 3680  
260-199, Itaewon-Dong.  
Yongsan-Ku, Seoul 140-202  
Phone: 080 600 6600 (toll free)  
Fax : (02) 709 1210

## MALAYSIA

After Market Solutions Sdn Bhd,  
Philips Authorised Service Center,  
Lot 6, Jalan 225, Section 51A,  
46100 Petaling Jaya,  
Selangor Darul Ehsan,  
Malaysia.  
Phone: (603)-7954 9691/7956 3695  
Fax: (603)-7954 8504  
Customer Careline: 1800-880-180

## PAKISTAN

Philips Consumer Service  
Mubarak manzil,  
39, Garden Road, Saddar,  
Karachi-74400  
Tel: (9221) 2737411-16  
Fax: (9221) 2721167  
E-mail: care@philips.com  
Website: www.philips.com.pk

## PHILIPPINES

PHILIPS ELECTRONICS & LIGHTING, INC.

Consumer Electronics

48F PBCOM tower

6795 Ayala Avenue cor VA Rufino St.

Salcedo Village

1227 Makati City, PHILS

Phone: (02)-888 0572, Domestic Toll Free: 1-800-10-PHILIPS or 1-800-10-744 5477

Fax: (02)-888 0571

## SINGAPORE

Accord Customer Care Solutions Ltd

Authorized Philips Service Center

Consumer Service

620A Lorong 1 Toa Rayoh

Singapore 319762

Tel: +65 6882 3999

Fax: +65 6250 8037

## TAIWAN

Philips Taiwan Ltd.

Consumer Information Centre

13F, No. 3-1 Yuan Qu St., Nan Gang Dist.,

Taipei 115, Taiwan

Phone: 0800-231-099

Fax : (02)-3789-2641

## THAILAND

Philips Electronics (Thailand) Ltd.

26-28th floor, Thai Summit Tower

1768 New Petchburi Road

Khwaeng Bangkokkapi, Khet Huaykhwang

Bangkok10320 Thailand

Tel: (66)2-6528652

E-mail: cic Thai@philips.com

## MOROCCO

Philips Electronique Maroc  
304,BD Mohamed V  
Casablanca  
Phone: (02)-302992  
Fax : (02)-303446

## SOUTH AFRICA

PHILIPS SA (PTY) LTD  
Customer Care Center  
195 Main Road  
Martindale, Johannesburg  
P.O. box 58088  
Newville 2114  
Telephone: +27 (0) 11 471 5194  
Fax: +27 (0) 11 471 5123  
E-mail: [phonecare.za@philips.com](mailto:phonecare.za@philips.com)

## Middle East

### DUBAI

Philips Middle East B.V.  
Consumer Information Centre  
P.O.Box 7785  
DUBAI  
Phone: (04)-335 3666  
Fax : (04)-335 3999