

Register your product and get support at  
[www.philips.com/welcome](http://www.philips.com/welcome)

4300 series - LED TV

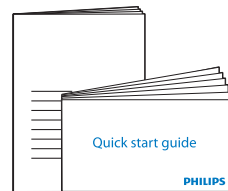

**PHILIPS**

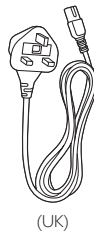
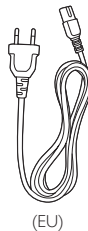
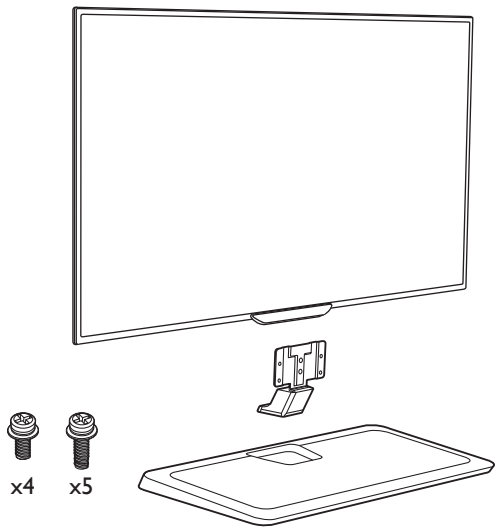
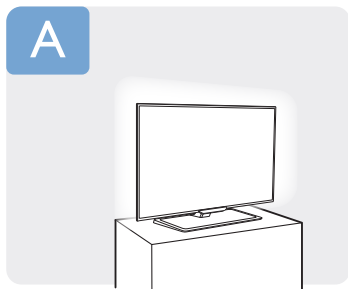

p.3

or

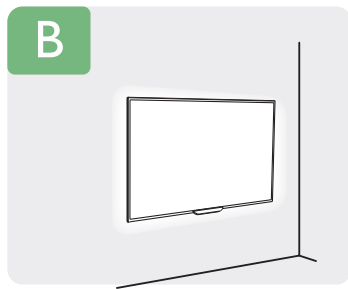

p.5



**English** Read the safety instructions.  
**Български** Прочетете инструкциите за безопасност.  
**Čeština** Přečtěte si bezpečnostní pokyny.  
**Hrvatski** Pročitajte sigurnosne upute.  
**Dansk** Læs sikkerhedsforskrifterne.  
**Deutsch** Lesen Sie die Sicherheitshinweise.  
**Ελληνικά** Διαβάστε τις οδηγίες ασφαλείας.  
**Eesti** Lugege ohutusõudeid.  
**Español** Lea las instrucciones de seguridad.

**Français** Lisez les consignes de sécurité.  
**Italiano** Leggere le istruzioni di sicurezza.  
**Қазақша** Қорғаныстық нұсқаулар.  
**Lietuvių** Izlasiet drošības norādījumus.  
**Magyar** Perskaitykite saugos instrukcijas. Olvassa el a biztonsággi utasításokat.  
**Nederlands** Lees de veiligheidsvoorschriften.  
**Norsk** Les sikkerhetsforskriftene.  
**Polski** Zapoznaj się z instrukcjami bezpieczeństwa.

**Português** Leia as instruções de segurança.  
**Română** Citiți instrucțiunile de siguranță.  
**Русский** Читайте инструкции по технике безопасности.  
**Srpski** Pročitajte bezbednosna uputstva.  
**Slovenščina** Preberite varnostna navodila.  
**Slovenský** Prečítajte si bezpečnostné pokyny.  
**Suomi** Lue turvaohjeet.  
**Svenska** Läs säkerhetsinstruktionerna.  
**ภาษาไทย** โปรดอ่านคำแนะนำด้านความปลอดภัย

**Türkçe** Güvenlik talimatlarını okuyun.  
**Українська** Читайте інструкції з техніки безпеки.

**العربية** قراءة تعليمات السلامة.  
**עברית** קראו את הוראות הבטיחות

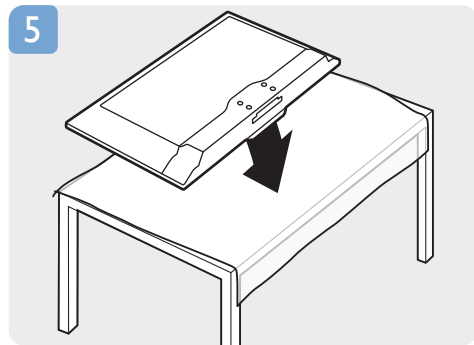
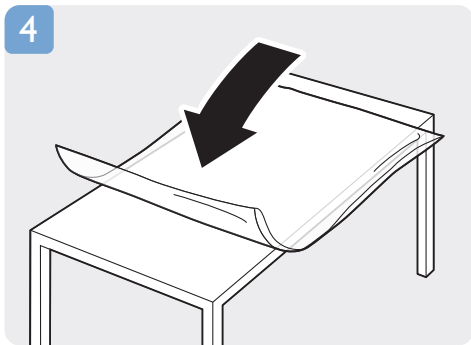
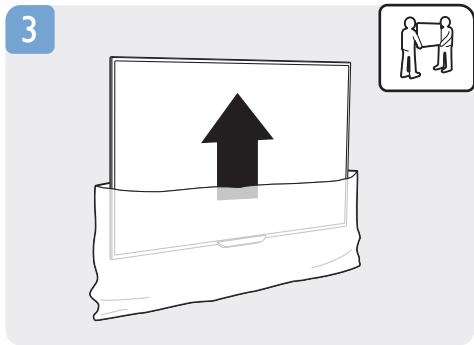
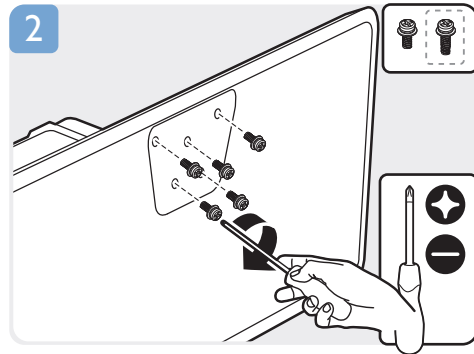
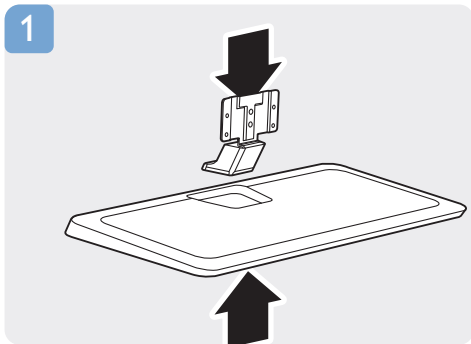
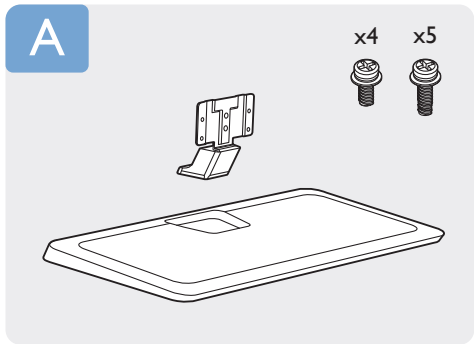

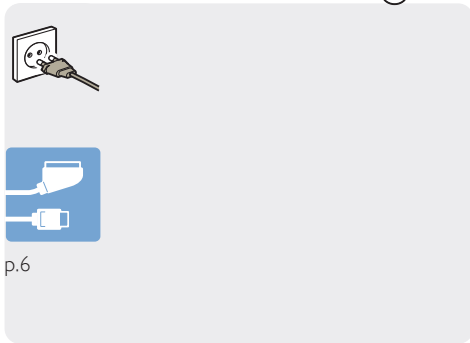
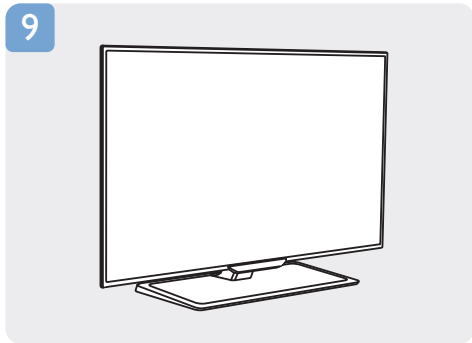
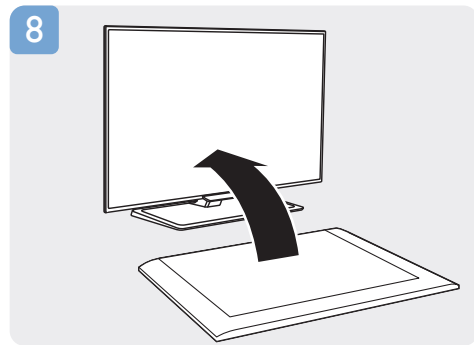
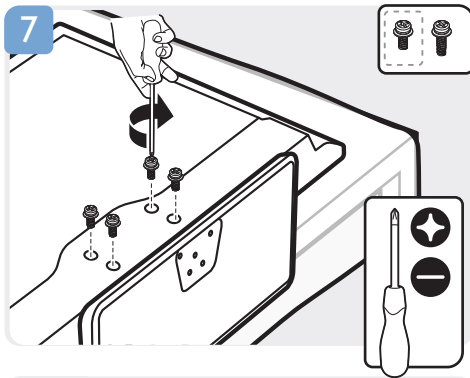
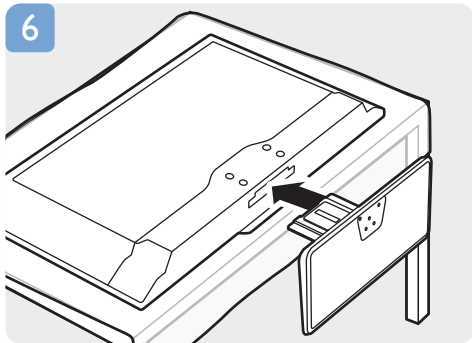

B

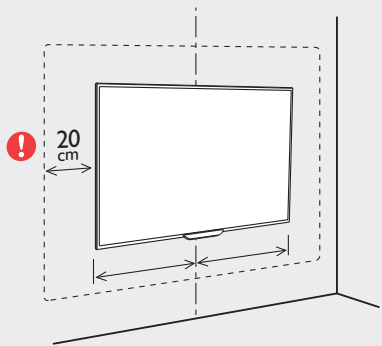

p.6

VESA (x, y)  
32" 100x100 M4

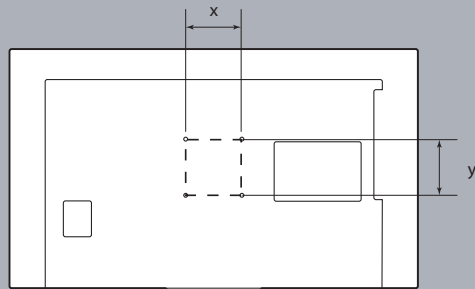
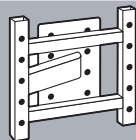

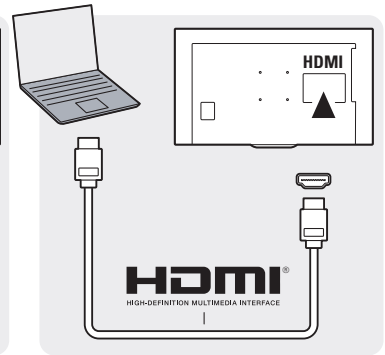
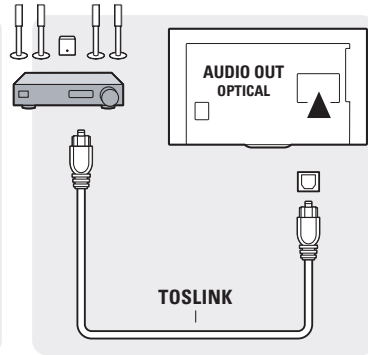
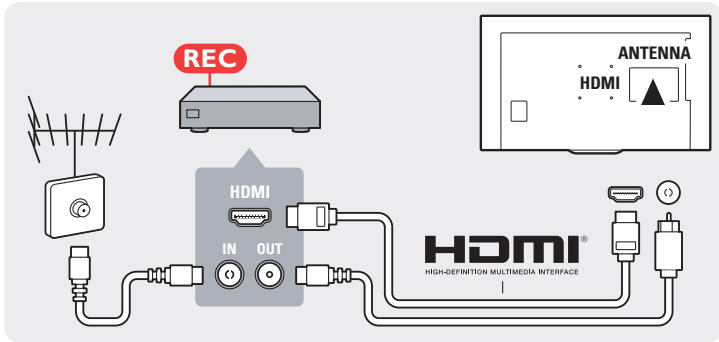
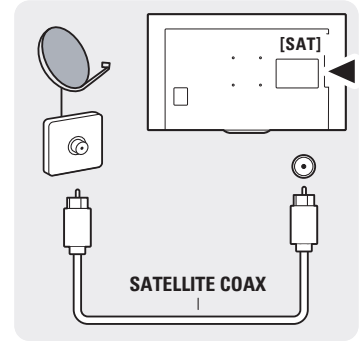
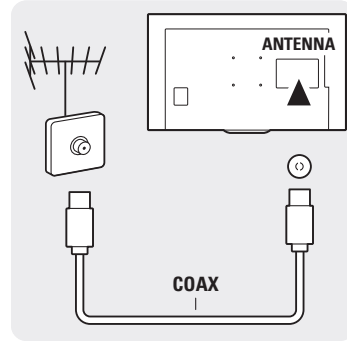
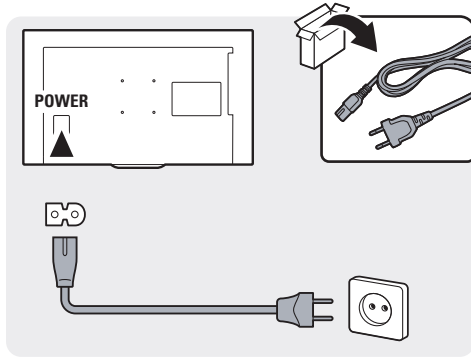
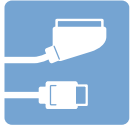

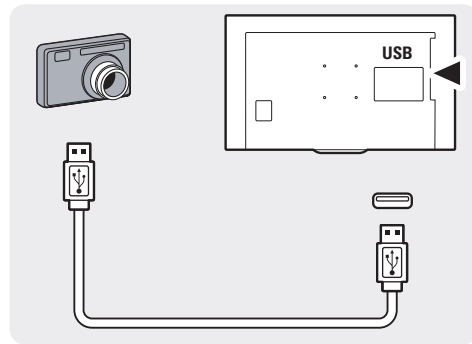
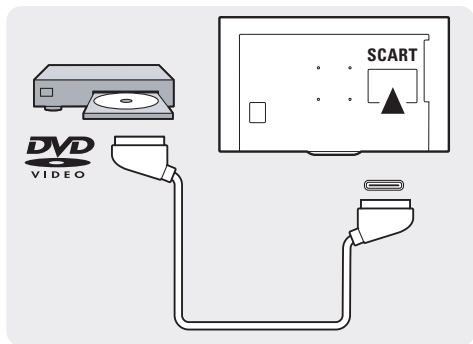
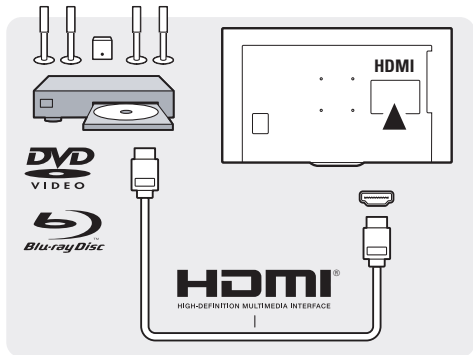

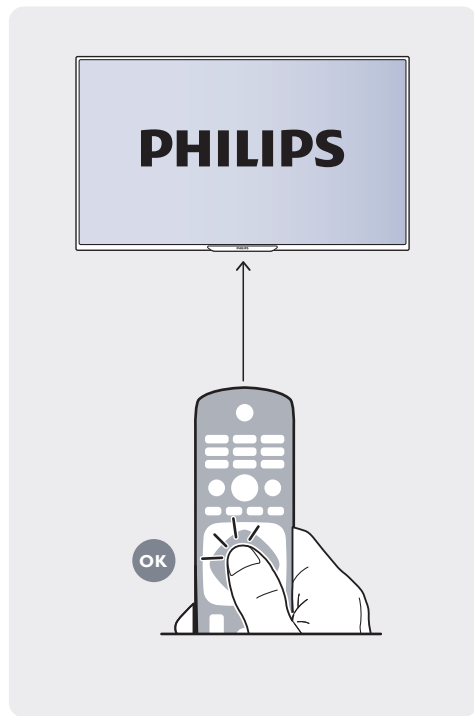
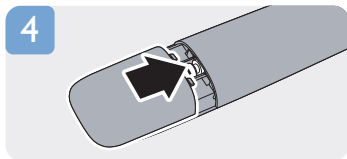
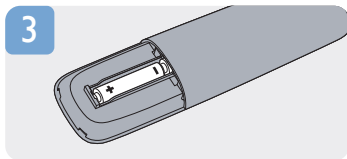
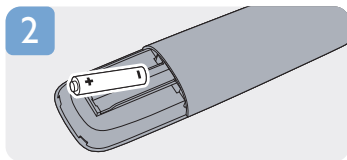
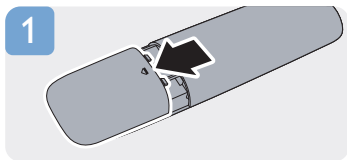











Always here to help you

[www.philips.com/support](http://www.philips.com/support)



User Manual



Frequently Asked Questions



Warranty



Philips support forum



Live Chat



Call Center



Email

### България

Грижа за клиента  
02 4916 273  
(Национален номер)

### België/Belgique

Klantenservice/  
Service Consommateurs  
070 700 035  
(0,15€/min.)

### Bosna i Hercegovina

Potpora potrošačima  
033 941 251  
(Lokalni poziv)

### Србија

Potpora potrošačima  
011 321 6840  
(Lokalni poziv)

### Česká republika

Zákaznická podpora  
228 880 895  
(Místní tarif)

### Danmark

Kundeservice  
3525 8314

### Deutschland

Kundendienst  
069 66 80 10 10  
(Zum Festnetztarif ihres Anbieters)

### Ελλάδα

Τμήμα καταναλωτών  
2111983028  
(Διεθνής κλήση)

### Eesti

Klienditugi  
6683061  
(Kohalikul kõned)

### España

Atención al consumidor  
902 88 10 83  
(0,10€ + 0,08€/min.)

### France

Service Consommateurs  
01 57 32 40 50  
(coût d'un appel local sauf surcoût éventuel selon opérateur réseau)

### Hrvatska

Potpora potrošačima  
01 777 66 01  
(Lokalni poziv)

### Ireland

Consumer Care  
0818 210 140  
(National call)

### Italia

Servizio Consumatori  
02 45287014  
(Chiamata nazionale)

### Қазақстан Республикасы

байланыс орталығы  
810 800 2000 00 04  
(стационарлық нөмірлерден  
Қазақстан Республикасы бойынша  
конфирмау шалу тегін)

### Latvija

Klientu atbalsts  
6616 3263  
(Vietēlais tarifs)

### Lietuva

Klientų palaikymo tarnyba  
8 52140293  
(Vietiniais tarifais)

### Luxembourg

Service Consommateurs  
2487 1100  
(Appel national)/(Nationale Ruf)

### Magyarország

Ügyfélszolgálat  
(06 1) 700 8151  
(Belföldi hívás)

### Nederland

Klantenservice  
0900 202 08 71  
(0,10€/min.)

### Norge

Forbrukerstøtte  
22 97 19 14

### Österreich

Kundendienst  
0820 40 11 33  
(0,145€/Min.)

### Республика Беларусь

Контакт Центр  
8 10 (800) 2000 00 04  
(бесплатный звонок по  
Республике Беларусь со стационарных  
номеров)

### Российская Федерация

Контакт Центр  
8 (800) 220 00 04  
бесплатный звонок по России

### Polska

Wsparcie Klienta  
22 3971504  
(Połączenie lokalne)

### Portugal

Assistência a clientes  
707 78 02 25  
(0,12€/min. – Móvel 0,30€/min.)

### România

Serviciul Clienti  
031 6300042  
(Tarif local)

### Schweiz/Suisse/Svizzera

Kundendienst/Service Consommateurs/  
Servizio Consumatori  
0848 000 291  
(0,081 CHF/Min)

### Slovenija

Služba za potrošnike  
01 8888 312  
(Lokalni klic)

### Slovensko

Zákaznická podpora  
02 - 33215493  
(vnútroštátny hovor)

### Suomi

Finland Kuluttajapalvelu  
09 8862 5040

### Sverige

Kundtjänst  
08-5792 9096

### Türkiye

Tüketici Hizmetleri  
444 8 445

### Україна

Служба підтримки споживачів  
0-800-500-480  
(зв'язки зі стационарних телефонів  
безкоштовні)

### United Kingdom

Consumer Care  
0844 338 04 88  
(5p/min BT landline)

### Argentina

Consumer Care  
0800 444 7749

### Buenos Aires

Consumer Care  
0810 444 7782

### Brasil

Suporte ao Consumidor  
0800 701 0245

### Brasil (São Paulo)

Suporte ao Consumidor  
2938 0245



All registered and unregistered trademarks are the property of their respective owners. Specifications are subject to change without notice. Philips and the Philips' shield emblem are registered trademarks of Koninklijke Philips N.V. and are used under license from Koninklijke Philips N.V. 2014 ©TP Vision Europe B.V. All rights reserved. [www.philips.com](http://www.philips.com)