

Register your product and get support at
www.philips.com/welcome

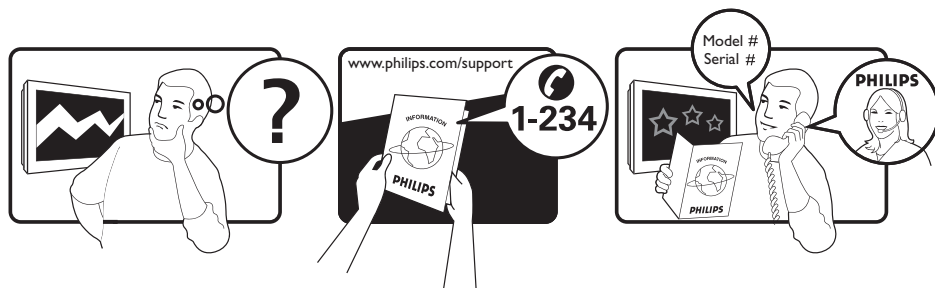

EN USER MANUAL

PHILIPS



Country	Number	Tariff
Austria	0810 000205	0.07/min
Belgium	078250145	0.06/min
Czech Rep	800142840	free
Denmark	3525 8759	local
Finland	09 2311 3415	local
France	0821 611655	0.09/min
Germany	01803 386 852	0.09/min
Greece	0 0800 3122 1280	free
Hungary	0680018189	free
Ireland	01 601 1777	local
Italy	840320086	0.08/min
Luxemburg	40 6661 5644	local
Netherlands	0900 8407	0.10/min
Norway	2270 8111	local
Poland	0223491504	local
Portugal	2 1359 1442	local
Slovakia	0800004537	free
Spain	902 888 784	0.10/min
Sweden	08 5792 9100	local
Switzerland	0844 800 544	local
UK	0870 900 9070	local

This information is correct at the time of press.

For updated information, see www.support.philips.com

Contents

Introduction	3	Opting to use a pin code	16
Safety	4	Changing your pin code	16
Television keys and connectors	5	Options for restricting access to digital channels	16
Getting started	6	Using the Common Interface slot	16
Mounting the TV on a wall	6	Setting up lists of favourite channels	17
Connecting the aerial and mains	6	Updating software automatically	18
How to switch your TV on	6	Obtaining the software version	18
Putting batteries in the remote control	6	Information about software downloads ..	18
Remote control functions	7	Downloading new software	18
Switching the TV on for the first time	9	Using the Options menu	19
Going back to the Installation menu	9	Getting programme listings	20
Understanding the information banner	10	Using digital teletext	21
Viewing or listening to digital TV and radio	11	Analogue teletext in digital mode	21
Changing the order of stored channels ..	11	Using conditional access	22
Checking for new TV channels or radio stations	11	Tuning analogue channels automatically	23
Setting up TV and radio channels	12	Tuning analogue channels manually	24
Adding new channels or stations to your list	12	Renumbering channels	25
Reinstalling all channels	12	Naming channels	26
Installing digital channels manually	13	Selecting your favourite channels	27
Testing your TV reception	13	Adding or removing channels from your list of favourites	27
Selecting your language and location	14	Setting the timer	28
Setting your language and location	14	Blocking channels (Parental Control)	29
Resetting the language to your preferred language	14	Creating a pin code for parental control	29
Submenu options for language	14	Blocking and unblocking selected channels	29
Submenu options for location	15	Changing your pin code for parental control	30
Restricting access to digital channels	16	Blocking or unblocking all channels	30

Locking the side controls (Child Lock)	31	Troubleshooting	43
Enjoying Ambilight	32	Environmental Information	45
Switching Ambilight on and off.....	32	Information for users in the UK	46
Configuring Ambilight settings.....	32		
Adjusting picture and sound settings	33		
Picture settings	33		
Sound settings	33		
Using Smart Picture and Smart Sound	35		
Using Smart Picture	35		
Using Smart Sound.....	35		
Picture Formats	36		
Using teletext	37		
Using the TV in High Definition mode	39		
Connecting HD equipment to your TV..	39		
Adjusting picture or sound settings in HD mode	39		
Picture settings in HD mode	39		
Sound settings in HD mode.....	39		
Configuring the TV in HD mode.....	40		
Displaying in native 1080 mode.....	40		
Supported formats	41		
Using Auto HDMI.....	41		
HDMI 1.3a CEC.....	41		
Using the TV as a PC Monitor	42		
Connecting a PC to your TV.....	42		
Adjusting picture or sound settings in PC mode	42		
Picture settings in PC mode.....	42		
Sound settings in PC mode	42		
Configuring the TV in PC mode	42		
Supported PC resolutions	42		

Introduction

Congratulations on your purchase and welcome to Philips!

To fully benefit from the support that Philips offers, register your product at www.philips.com/welcome.

This manual contains information about how to install and operate your TV.



If you still have problems after reading this manual, call your Local Philips Customer or Service Centre. The telephone numbers and addresses are given in the worldwide guarantee booklet supplied with the TV.

Product information

The model and serial number can be found at the rear of the TV, on left side of the TV, and on the packaging.

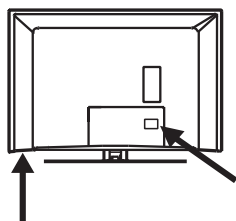

Product features

Note: Available in selected models



Caring for the screen

1. Do not remove the protective sheet until you have completed the stand or wall mounting and connections.
2. Use the soft cloth that is provided to clean the front of the TV.
3. Do not use a cloth that is dripping with water. Do not use acetone, toluene or alcohol to clean the TV. As a safety precaution, unplug the power cord from the mains when you clean the set.

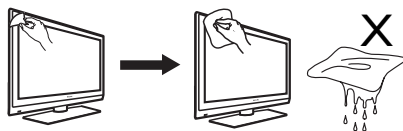

4. Do not touch, push or rub or strike the screen with anything hard as this may scratch or damage the screen permanently.

Safety

1. Two people are required to lift and carry a TV that weighs more than 25 kilogrammes. Improper handling of the TV can cause serious injury.
2. If you place the TV set on a surface, ensure the surface is level and that it can withstand the weight of the TV.
3. Mounting the TV on the wall requires special skill that should only be performed by a qualified personnel. You should not attempt to do the work yourself. Philips bear no responsibility for improper mounting or mounting that results in accident or injury.
4. This TV is compatible with the VESA wall mounting standard. Please contact your local electronics retailer for a VESA compliant bracket to wall mount this TV. Before you mount your TV on a wall, ensure the wall is suitable to carry the weight of the TV.
5. Wherever you place or mount the TV, ensure that air can circulate freely through the ventilation slots. Do not place the TV in a confined space.
6. Do not place naked flame sources such as lighted candles close to the TV.
7. Do not expose the TV or the batteries of the remote control to heat, direct sunlight, rain, or water.

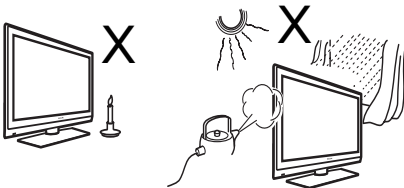

8. Do not place a vessels filled with water on top of or near to the TV. Spilling water into the TV can result in electric shock. If you spill water into the TV, do not operate the TV. Immediately

disconnect the TV from the mains and have the TV checked by a qualified technician.

9. Do not touch any part of the TV, power lead, or aerial lead during lightning storms.
10. Do not leave the TV in standby mode for an extended period of time. Instead, disconnect the TV from the mains.
11. The TV set is always connected to the mains. You can disconnect the TV from the mains by doing one of the following tasks:
 - unplugging the mains cord located at the back of TV set
 - unplugging the mains plug from the mains socket outletPull the power cord by the plug - do not pull on the power cord.
12. Ensure that you always have easy access to the mains cord or the mains plug to disconnect the TV from the mains.

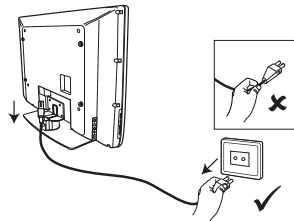

13. Ensure the power cord is fully inserted into the TV mains socket and the wall socket.
14. If the TV is mounted on a swivel base or swivel arm, ensure no strain is placed on the power cord when the TV is swivelled. Strain on the power cord can loosen connections and cause arcing or fire.
15. Verify that the mains supply voltage in your home corresponds to the voltage printed on the sticker at the rear of the TV.

Television keys and connectors

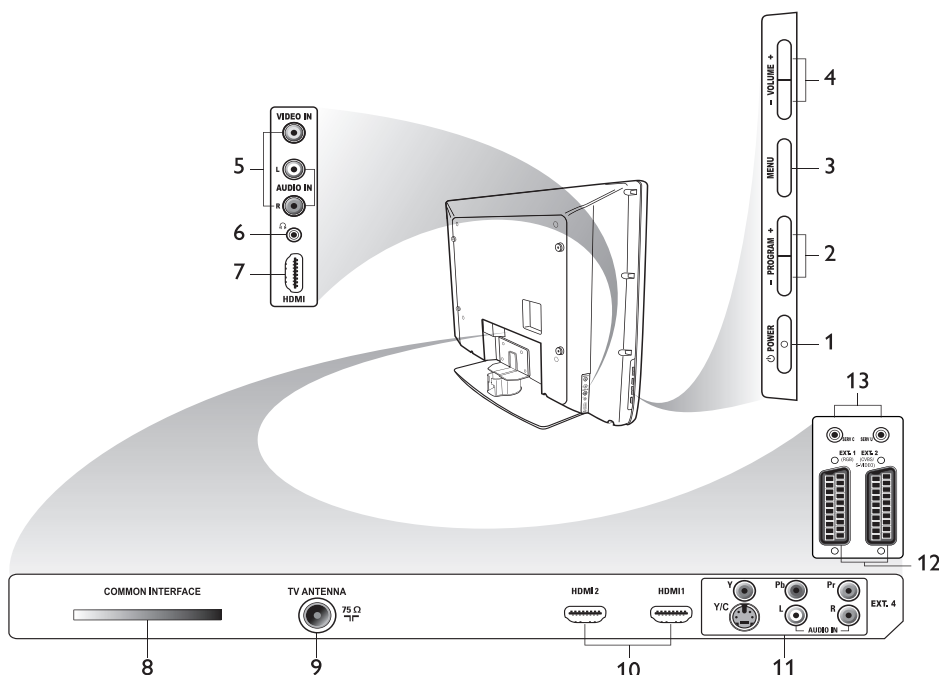

1. **POWER**
To switch the TV on and off. To disconnect from the mains, remove the mains cord from the mains socket at the back of the TV or remove the mains plug from the wall socket.
2. **- PROGRAM +**
To select a channel.
3. **MENU**
To display or close menus.
4. **- VOLUME +**
To increase or decrease volume.
5. **Audio Video**
To connect to a camera or camcorder.
6. **Headphones** 
To connect headphones. The mute function does not work when headphones are plugged in.
7. **Side HDMI**
To connect to peripheral equipment, including high-definition equipment.
8. **Common Interface (CI) slot**
To connect a Conditional Access card such as a cable card or smartcard.
9. **TV Aerial**
To connect to the aerial plug.
10. **HDMI**
To connect to peripheral equipment, including high-definition equipment. Some models have three HDMI connectors.
11. **EXT 4 Y/C and EXT 4 YPbPr**
To connect to peripheral equipment. Only one video connection can be used at a time.
12. **EXT 1 (RGB) and EXT 2 (CVBS/S-VIDEO)**
To connect peripheral equipment.
13. For service use (do not insert the headphones here).

Getting started

Mounting the TV on a wall

This TV is compatible with the VESA wall mounting standard. Please contact your local electronics retailer for a VESA compliant bracket to wall mount this TV.

Insert the cables into the TV before you mount it on the wall.

Ensure that there is a distance of at least 30 mm between the wall and the back of the TV. For sets with subwoofer, an additional 10mm is required for optimal sound effect.

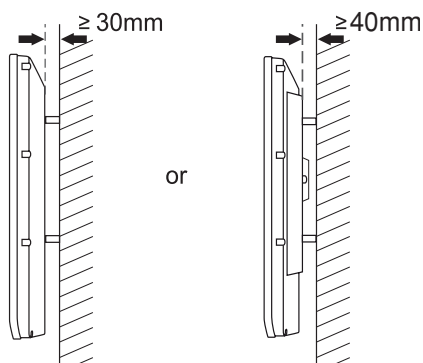

Connecting the aerial and mains

Insert the aerial plug and the mains cord firmly into their respective socket at the bottom of the TV before connecting them into the wall socket.

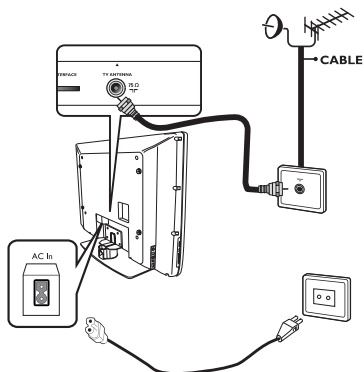

How to switch your TV on

To switch the TV on, press the **POWER** key on the side controls. A blue indicator light comes on and after a few seconds the screen lights up.

If the TV set remains in standby mode, the indicator light remains red. Press the **PROGRAM +/-** key on the side controls or press the **P +/-** key on the remote control.

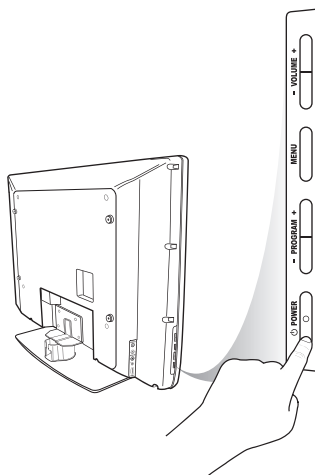

Putting batteries in the remote control

Insert the batteries into the remote control, ensuring that the + and - ends of the batteries are aligned correctly. The correct alignment is indicated inside the casing of the remote control.

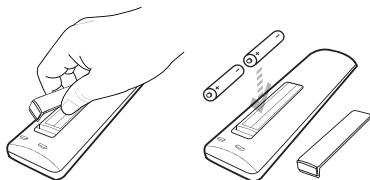

Remote control functions

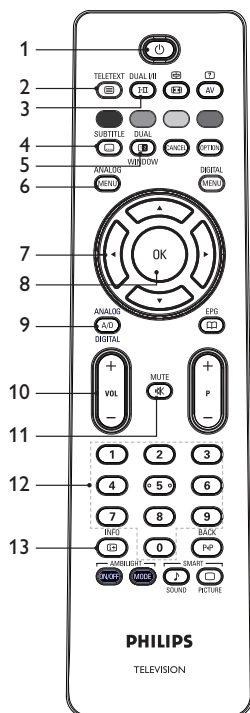

1. **Standby**
To put the TV in standby mode or to switch the TV on. Alternatively, press to , **P +/-**, or .
2. TELETEXT
 Teletext
For information about using teletext, see *Using teletext* on page 37.
3. DUAL I/II
 Sound mode
To change programmes to **Mono** from **Stereo** and **Nicam Stereo**.
- For bilingual programmes, select **Dual I** or **Dual II** as indicated during the broadcast.
- In digital mode, **I-II** displays the list of audio languages.
4. SUBTITLE
 Subtitles
To activate or deactivate subtitles in digital mode.
5. DUAL WINDOW
 Teletext (Dual Window)
For information about using teletext, see *Using teletext* on page 37.
6. ANALOG
 Analogue menu
To enter or exit the TV menus in analogue mode.
7. **▲, ▼, ◀, ▶**
To select and adjust menu options.
8. **OK**
To confirm selections and access the program list in digital mode.
9. **Analogue/Digital**
To switch between analogue and digital mode.
10. **+ VOL -**
To increase or decrease volume.
11. MUTE
 Mute
To turn the speaker sound on or off.
12. to Numerical keys
To access programme numbers directly. For a two digit programme number, enter the 2nd digit soon after the first digit, before the dash disappears.
13. INFO
 Screen information
- In **digital** mode, to display or exit the information banner. For information see *Understanding the information banner* on page 10.
- In **analogue** mode, to display or remove the programme number, the sound mode, the clock and the remaining time of the sleep timer.

Remote control functions (cont.)

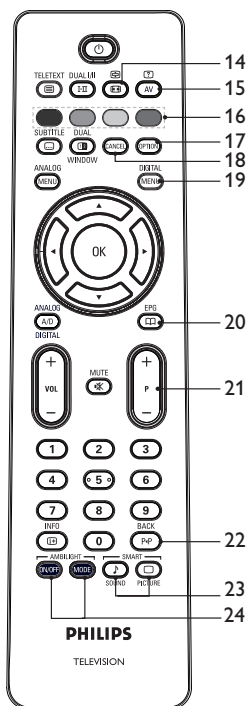

14. **Picture format**
To change the picture format. For more information about see *Picture Formats* on page 36.
15. **Source List**
To display the list of sources on which you can view your TV or your peripheral equipment.
16. **Teletext colours**
For information about using teletext, see *Using teletext* on page 37.
17. **Options**
For information about using options, see *Using the Options menu* on page 19.

18. **Cancel**
To exit teletext in digital mode. Use this key if there are no colour key to exit teletext.

19. **Digital menu**
To display or exit from the digital menu in digital mode.

20. **Programme listings**
To obtain programme listings. For information, see *Getting programme listings* on page 20.

21. **+ P – Programme**
To select the previous or next TV channel.

22. **BACK**
To toggle between the previously viewed channel and the current channel. This key can also be used to edit or move back when you are naming channels.

23. **Smart picture and sound**
To toggle between predefined picture settings and sound settings. For information, see *Using Smart Picture and Smart Sound* on page 35.

24. **Ambilight**
Applies only to TVs equipped with the Ambilight feature.
- ON/OFF: To switch ambilight on or off.
- MODE: To select the ambilight mode.

Switching the TV on for the first time

When you turn the TV on for the first time, the TV is in digital mode and the following menu appears on screen.

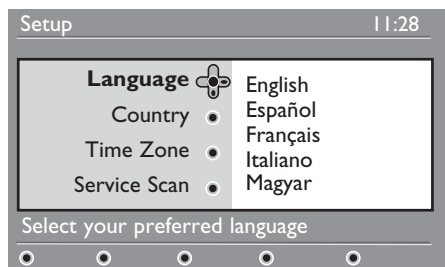

Going back to the Installation menu

This procedure resets both the digital and analogue modes to the factory default settings.

1. On the side controls of the TV set, press and hold down the **MENU** key for 5 seconds. A menu appears on the screen.
2. Select your language, country and time zone as if this is the first time you have turned on the TV.

Selecting your language, country and time zone

1. Press the ► key to enter **Language**, and press the ▲ or ▼ key to select your preferred language.
2. Press the **OK** key to confirm your selection.

3. Press the ▲ or ▼ key to highlight **Country** or **Time Zone**, and press the ► key to enter **Country** or **Time Zone**.

Note: If you select the wrong country, the channel numbering will not conform to the standard for your country. You might receive fewer or no services.

4. Press the ▲ or ▼ key to select your preferred **Country** or **Time Zone**.
5. Press the **OK** key to confirm your selection.
6. Press the ▼ key to select **Service Scan**.
7. Press the **OK** key to start the installation. The TV searches for the available analogue and digital channels.
8. If no digital channels are detected, press **A/D** key to switch to analogue mode.

Understanding the information banner





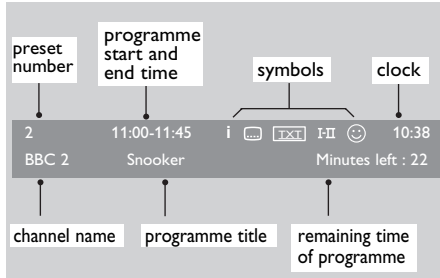



When you select a digital programme, an information banner is displayed at the top of the screen. The banner disappears after a few seconds.

Note: A white symbol ☺ appears if the channel is stored in one or more of the list of favourites channels which are currently not activated.



The information banner contains the preset number, channel name, programme title, programme start time, programme end time, clock, and the remaining time for the current programme.

Description of the symbols on the information banner

- **i** More information about this programme is available.
To display more information, press the  key once. Press the  key a second time to remove the information.
-  Subtitling is available
To access subtitles, press the  key. Alternatively, press the  key to access the options menu and then select subtitles.
-  Analogue teletext is available in digital mode.
- **I-II** Other languages are available
To select other languages press the  key. Press the  key to access the options menu.
- ☺ The colour of the symbol (red, green, yellow or blue) indicates the selected list of favourite channels.

Viewing or listening to digital TV and radio

Changing the order of stored channels

You can change the order of the digital channels and radio stations that you have stored.

1. If you are in analogue mode, switch to digital mode by pressing the **A/D** key on the remote control.
2. Press the **DIGITAL MENU** key to display the setup menu.
3. Press the **▼** key to select **Installation**, and press the **▶** key twice to select the **Service lists menu**.

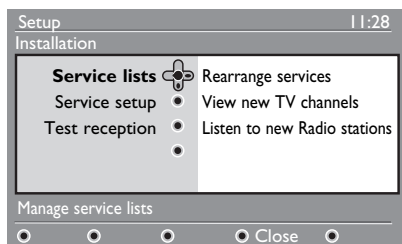

4. Press the **▲** or **▼** key to select **Rearrange services**, and press the **▶** key.

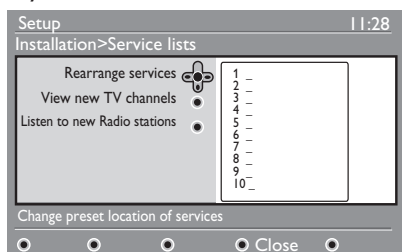

5. Press the **▲** or **▼** key to highlight the channel you want to select.
6. Press **OK** key to activate the channel. To uninstall the selected channel, press the red key.
7. Press the **▲** or **▼** key to select the new channel number.

8. Press the green key to confirm your choice. The exchange is complete.
9. Repeat the previous steps until all of the channels are in the required order.
10. Press the **◀** key to return to the previous menu.
11. Press the **DIGITAL MENU** key to exit the menu.

Checking for new TV channels or radio stations

You can check for the availability of TV channels or radio stations that have been launched by the broadcaster after you have installed the TV.

1. If you are in analogue mode, switch to digital mode by pressing the **A/D** key on the remote control.
2. Press the **DIGITAL MENU** key to display the setup menu.
3. Press the **▼** key to select **Installation**, and press the **▶** key twice to select the **Service lists menu**.
4. Press the **▲** or **▼** key to select **View new TV channels** or **Listen to new Radio stations**.
5. If new services are available, press the **▶** key to enter into the list of services, and press the **▲** or **▼** key to move through the list. For information about how to add the new services to your list of favourite channels, see *Adding new channels or stations to your list*, on page 12.
6. Press the **◀** key to return to the previous menu.
7. Press the **DIGITAL MENU** key to exit the menu.

Setting up TV and radio channels

Adding new channels or stations to your list

You can search for new TV channels or radio stations that have been launched by the broadcaster after the initial installation.

1. If you are in analogue mode, switch to digital mode by pressing the **(A/D)** key on the remote control.

2. Press the **(DIGITAL MENU)** key to display the setup menu.
3. Press the **(V)** key to select **Installation**, and press the **(R)** key.

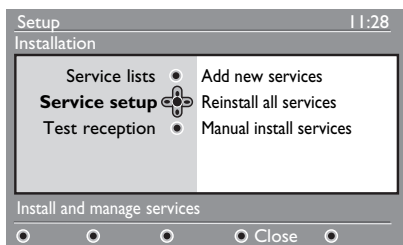

4. Select **Service setup**, and press the **(R)** key.
5. Press **(R)** to add new services, and press the **(OK)** key to activate the installation.

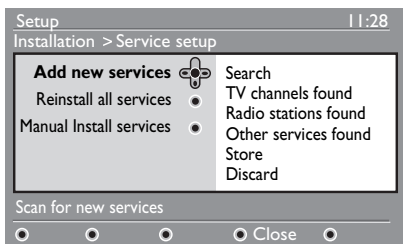

A search begins. Any new channels are added to the channel list menu. The percentage of the installation that has been completed and the number of channels found is displayed.

6. When the search is complete, press the **(OK)** key to accept the new services.

7. Press the **(L)** key to return to the previous menu.
8. Press the **(DIGITAL MENU)** key to exit the menu.

Reinstalling all channels

This menu allows you to reinstall all the digital TV channels and radio stations.

1. If you are in analogue mode, switch to digital mode by pressing the **(A/D)** key on the remote control.
2. Press the **(DIGITAL MENU)** key to display the setup menu.
3. Use the **(V)** key to select **Installation**, and press the **(R)** key.
4. Select **Service setup**, and press the **(R)** key.
5. Select **Reinstall all services**, and press the **(R)** key.

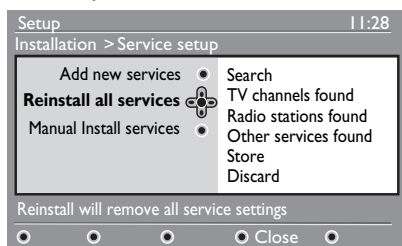

6. Press the **(OK)** key to start the installation. A search for digital services is started. The services are stored automatically. When the search is complete, the menu indicates the number of digital services found.
7. Press the **(OK)** key to store the services.
8. Press the **(L)** key to return to the previous menu.
9. Press the **(DIGITAL MENU)** key to exit the menu.

Setting up TV and radio channels (cont.)

Installing digital channels manually

You can manually scan services by keying in the frequency of your target channel.

1. If you are in analogue mode, switch to digital mode by pressing the **A/D** key on the remote control.

2. Press the **DIGITAL (MENU)** key to display the setup menu.
3. Select **Service setup**, and press the **▶** key.
4. Select **Manual install services**, and press the **▶** key.

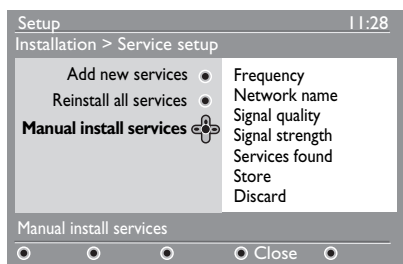

5. Press the **0** to **9** keys to key in the frequency of your target channel, and press **OK** key to start the search.
6. When the search is complete, press the **OK** key to accept the new service.
7. Press the **◀** key to return to the previous menu.
8. Press the **DIGITAL (MENU)** key to exit the menu.

Testing your TV reception

This menu allows you to check the strength of the signal that you are receiving through your aerial.

1. From the digital mode, press the **DIGITAL (MENU)** key to display the setup menu.

2. Press the **▼** key to select **Installation**, and press the **▶** key.

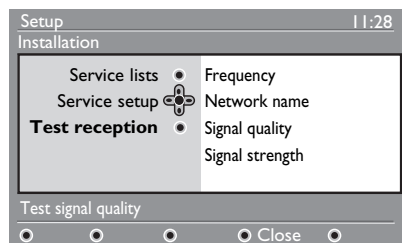





3. Press the **▼** key to select **Test reception**, and press the **▶** key. The programme frequency, the network name, the signal quality, and the signal strength are displayed.
4. Press the **▶** key to enter the **Frequency**, and press the **0** to **9** keys to enter the frequency of the digital channel that you want to test.
 - Press the **▶** key to move to the next character space.
 - If the test reception indicates that the signal strength is poor, adjust or update your aerial. Contact a professional aerial installer for best results.
5. After keying in the frequency, press the **OK** key to exit **Frequency**.
6. Press the **◀** key to return to the previous menu.
7. Press the **DIGITAL (MENU)** key to exit the menu.







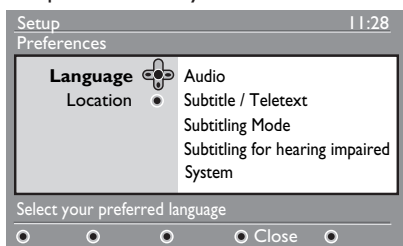

Selecting your language and location

You can select your preferred language, country and time zone.

Setting your language and location

1. If you are in analogue mode, switch to digital mode by pressing the  key on the remote control.
2. Press the  key to display the setup menu.
3. Press the  key to select **Preferences** and press the  key.













4. Select **Language** or **Location**, and press the  key.
5. Press the  or  key to select an option, and press the  key to enter into its sub-menu.
6. Select your values, and press the  or  key to exit.
7. Press the  key to return to the previous menu.
8. Press the  key to exit the menu.

Resetting the language to your preferred language

If you have selected the wrong language and do not understand the selected language, perform the following steps to bring you back to your preferred language.

1. Press the  key to exit the menu.

2. Press the  key again to display menu.
3. Press the  key to select the second item in the menu.
4. Press the  key to enter into the next level of the menu.
5. Press the  key followed by the  key to select the fifth item on the menu.
6. Press the  key to enter into the next level of the menu.
7. Press the  or  key to select your preferred language.
8. Press the  key to confirm your selection.
9. Press the  key to exit the menu.

Submenu options for language

This list describes the submenu options for choosing your languages.

- **Audio:** To select the audio sound language.
- **Subtitle/Teletext:** To select the subtitle and teletext language.
- **Subtitling Mode:** To set subtitles to off, on, or auto. In auto mode, subtitles are displayed when they are supplied with the original audio transmission.
- **Subtitles for hearing impaired:** To activate or deactivate the subtitling for hearing impaired. This feature is available only if it is supplied in the broadcast.
- **System:** To select the menu language.

Selecting your language and location (cont.)

Submenu options for location

This list describes the submenu options for choosing your location.

- **Country:** To select the country where you are located.
- **Time zone:** To select the time zone where you are located.

The language can be selected independently from the country.

Caution: If you select a wrong country, the channels might not be numbered according to the standard for your country. Consequently, you might receive fewer or no services.

Restricting access to digital channels

You can restrict access to digital channels.

Opting to use a pin code

1. If you are in analogue mode, switch to digital mode by pressing the **(A/D)** key on the remote control.
2. Press the **(MENU)** key to display the setup menu.
3. Press the **▼** key to select **Access restrictions**, and press the **▶** key.
4. Press the **▶** key to enter into the **Set pin code protection** menu.

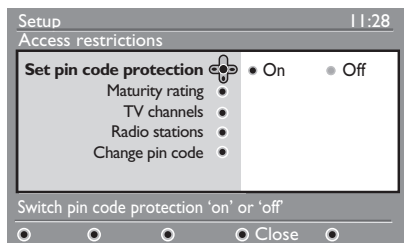

5. Press the **◀** or **▶** key to select **On**, and press the **(OK)** key to exit.
Warning: When you opt to use a pin code, you must use that pin code when you schedule a programme for recording.
6. Press the **◀** key to return to the previous menu.
7. Press the **(MENU)** key to exit the menu.

Changing your pin code

1. If you are in analogue mode, switch to digital mode by pressing the **(A/D)** key on the remote control.
2. Press the **(MENU)** key to display the setup menu.
3. Press the **▼** key to select **Access restrictions**, and press the **▶** key.

4. Press the **▼** key to select **Change pin code**.
5. Press the **▶** key to enter into the **Change pin code** menu.
6. Follow the on-screen instruction to change your pin code.

The default pin code is 1234.

If you forget your pin code, reset to the default pin code by entering the universal code 0711.

Options for restricting access to digital channels

This list describes the submenu options for access restrictions.

- **Maturity rating**
To select a rating at which a programme is blocked. This feature works only for programmes that are broadcast with a rating.
- **TV channels**
To select a TV channel to block.
- **Radio stations**
To select a radio station to block.
- **Change pin code**
To change your pin code.

Using the Common Interface slot

Your TV is equipped with a Common Interface (CI) slot. For information about using the CI slot see *Using conditional access* on page 22.

Setting up lists of favourite channels

You can create up to four lists of your favourite TV channels and radio stations.

1. If you are in analogue mode, switch to digital mode by pressing the **A/D** key on the remote control.

2. Press the **MENU** **DIGITAL** key to display the setup menu.

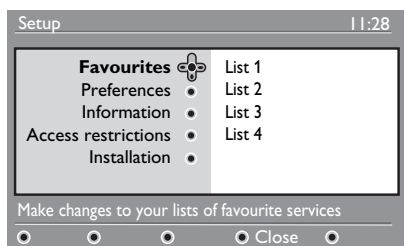

3. Press the **▶** key to enter the **Favourites** menu.
4. Press the **▲** or **▼** key to select **List 1**, **List 2**, **List 3**, or **List 4**, and press the **▶** key.
5. Press the **▲** or **▼** key to select a setting.
6. Press the **▶** key to enter into the submenu.

This list describes the options for the **Favourites** menu.

- **Name:**

To name a list.

- Press the **▲** or **▼** key to move around the name display area.
- Press the **P + / -** keys to select the characters. The name can contain up to 16 characters.
- Press the **P+P** key to change a character.
- When the name has been entered, press **OK** key to exit.

- **Select TV channels**

To add TV channels to a list.

- Press the **▲** or **▼** key to select a TV channel.
- Press the **OK** key to confirm your selection.
- Press the **◀** key to exit.

- **Select radio stations**

To add radio stations to a list.

- Press the **▲** or **▼** key to select a radio station.
- Press the **OK** key to confirm your selection.
- Press the **◀** key to exit.

- **Add all services**

To add all available services to a list.

- Press the **OK** key.

- **Remove all services**



To remove all services from a list.

- Press the **OK** key.



Updating software automatically

You can install new software and obtain information about the current software version.

Obtaining the software version

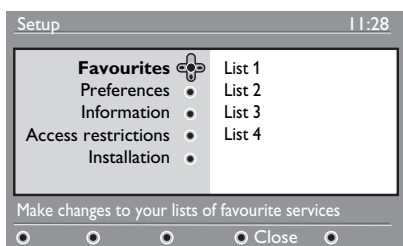
1. If you are in analogue mode, switch to digital mode by pressing the  key on the remote control.
2. Press the  key to display the setup menu.



3. Press the  key, and then the press  key twice to select **Information**. The software version is displayed.

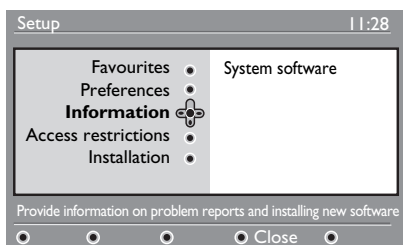

Information about software downloads

The software download menu describes the software and provides the date and time of the download.

New software can update menus or add new features. However, new software cannot change the way the TV operates.

You are advised to always download and

accept new software when it is available

When a download is accepted, the software is downloaded at the designated time and date.



You must put the TV into standby mode when the download is due.

If a problem occurs during the software download, you are informed about the next scheduled software download. Press the  key to return to using your TV normally.

If the software download is successful, a congratulatory message appears. Press the  key to return to using your TV normally.

You can obtain information about new software and upgrade instructions from www.philips.com.

Downloading new software

1. From the **Setup** menu, press the  key to enter the selection mode.
2. Press the  or  key to select **Yes** or **No**. If you select **Yes**, you choose to accept software updates automatically through off-air downloading.

In automatic mode, the TV detects whether an update is available while the TV it is in standby mode.

The next time the TV is turned on a message appears on the screen to indicate that new software is available.

Note: New software and upgrade instructions may also be obtained from the website: www.philips.com/support

3. Press the  key to activate the new software download.

Using the Options menu

You can directly access your list of favourite channels and configure your language and subtitle options.

1. If you are in analogue mode, switch to digital mode by pressing the **A/D** key on the remote control.
2. Display the options menu by pressing the white **OPTION** key.

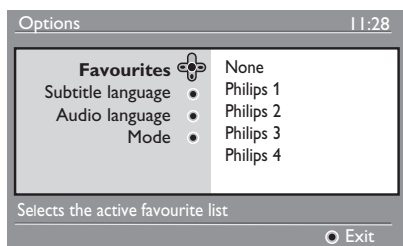

3. Press the **▲** or **▼** key to select an option, and press **►** key to enter its sub-menu.
4. When you have finished, exit the menu by pressing the white **OPTION** key.

This list describes the submenu of the **Options menu**.

- **Favourites**
To select you list of favourite channels.
 - Press the **▲** or **▼** key to select your list of favourite channels.
 - Press the **OK** key to confirm your selection.
 - To deactivate your lists of favourite channels, select **None**.

For information about how to create a list of favourite channels, see *Setting up lists of favourite channels* on page 17.

- **Subtitle language**
To change the subtitle language.

- Press the **▲** or **▼** key to select your language.
- Press the **OK** key to confirm your selection.

To permanently change the subtitle language, see *Selecting your language and location* on page 14.

- **Audio language**
To change the audio language.

- Press the **▲** or **▼** key to select your language.
- Press the **OK** key to confirm your selection.

To permanently change the audio language, see *Selecting your language and location* on page 14.

- **Mode**
To receive radio stations, TV channels or services.

Note (for the UK only): The TV list contains both radio stations and TV channels.

- **Banner duration**
To specify the amount of time that the information banner is displayed.

Getting programme listings



You can access an Electronic Programme Guide to provide you with a quick and easy way to view a list of digital programmes. You can navigate through the guide and obtain detailed information about the programmes.

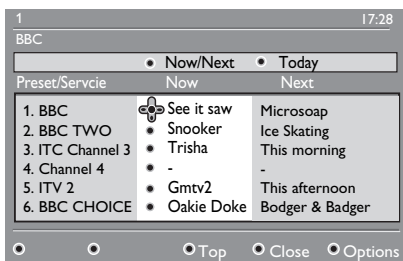

1. If you are in analogue mode, switch to digital mode by pressing the  key on the remote control.

2. Press the  key to display the Electronic Programme Guide.





A list of digital programmes in the currently selected favourites list is displayed.

3. Press the  key to enter into the **Preset/Service** list. Alternatively, press the  key to access the **Today** list.

4. Press the  or  key to select a programme.

5. Press the colour keys to activate the TV guide. The TV guide features are displayed at the bottom of the screen.

6. Press the  key to display more information about the selected programme. More information is displayed only if it is available.

7. When you have finished, press the  key to exit the menu.

This list describes the submenu for **Options**.

- **Top** (yellow key)
To access the top of the list.
- **Close** (blue key)
To exit from the TV guide.
- **Options** (white key)
To select your list of favourite channels, your mode, or your themes.

Themes are areas of interest. You can, for example, decide to display only the following themes: drama, news, or movies.

Using digital teletext





Note: Digital teletext is available in the U.K. only

The digital teletext services differs greatly from the analogue teletext service. The digital teletext service contains graphics and text that are laid out and controlled by the broadcaster. Some digital channels, offer a dedicated teletext services. Some digital channels also offer information about the programme being broadcast.



Sometimes, digital teletext takes priority over subtitles. In this case, subtitles do not reappear automatically when you exit from digital teletext on a channel that is broadcasting subtitles. To make subtitles reappear, toggle the  key on the remote control or change the channel.

To use digital teletext, follow the instructions on screen.

You use teletext by pressing the following keys:

- ◀ ▶ ▲ ▼ cursor keys
-  colour keys
-  teletext on/off key
-  to  numerical keys

If no colour key links are available in the Digital Teletext to allow you to exit teletext mode, use the  key instead.

When you switch to a digital channel with a teletext service, the teletext is downloaded in the background. Wait for the download to complete before you press the  key. If you press the  key before the download is complete, there is a short delay before the teletext is displayed.

When you navigate in digital teletext, there is a short delay while the page downloads. A prompt or message is often broadcast on the page to let you know the progress.

Analogue teletext in digital mode

Note: Analogue teletext is available in all countries

If you see the teletext icon  on a digital channel without digital teletext services, the icon indicates that analogue teletext is available in digital mode.

Press the  key to access analogue teletext.

If you have selected the UK as your country, press and hold the  key for at least 5 seconds.

For information about how to use the analogue teletext functions, see *Using teletext* on page 37.

Using conditional access

You use conditional access when you subscribe to some service providers such as pay TV.

The TV contains a Common Interface (CI) slot to receive a Conditional Access (CA) card.

When you subscribe to certain services, the service provider supplies you with a CA card, such as a cable card or smart card. Some service providers also supply you with a CI module to hold the CA card. The CI module is sometimes referred to as a PCMCIA adapter.

If your CA card is not provided with a CI module, ask your service provider for information about how to obtain a CI module.

If your CA card is provided with a CI module, insert the card into the CI module first, then insert the CI module into the CI slot on the TV.

The following instructions describe how to use conditional access.

1. Switch off the TV.
2. If your module comes with a viewing card, insert the CA card into the CI module. Ensure that the arrow on the CA card faces the arrow on the module.
3. Insert the CI module into the CI slot on the TV.

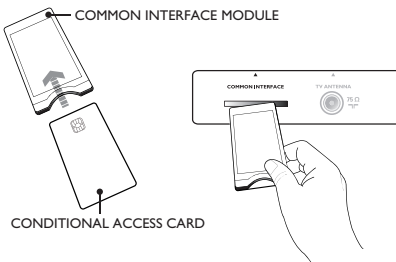

4. Switch on the TV.
5. Press the **DIGITAL** **(MENU)** key to enter the **Setup** menu.
6. Press the **▼** key to select **Access Restriction**, and then press the **▶** key.
7. Press the **▶** key to enter the **Conditional Access Module** menu.
8. Press the **(OK)** key to access the CAM functions, as indicated on the screen.

IMPORTANT

If the CA card or CI module is not inserted, or is inserted incorrectly, the CA menu will not be displayed.

The functions that appear on screen depend on the service provider.

Tuning analogue channels automatically

You can automatically search for and store analogue channels.

1. If you are in digital mode, switch to analogue mode by pressing the **A/D** key on the remote control.
2. Press the **ANALOG MENU** key to display the **Main** menu.

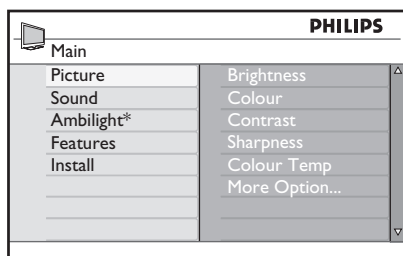

* Available in selected models

3. Press the **▲** or **▼** key to select **Install**, and press the **▶** or **OK** key to enter the **Install** menu.

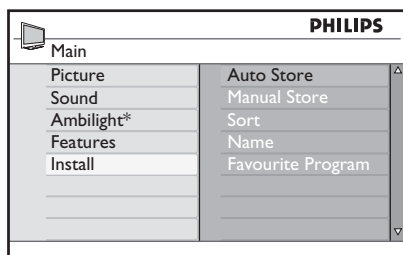

* Available in selected models

4. Select **Auto Store**, and press the **▶** or **OK** key to automatically search for channels.

All of the available channels are stored. The auto store operation takes a few minutes. The following display shows the progress of the search and the number of channels found.

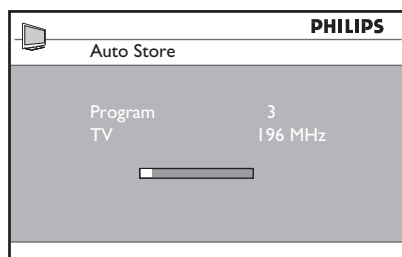

To exit or interrupt the search before it is complete, press the **ANALOG MENU** key.

If you interrupt an auto store, not all of the channels are stored. To store all channels, restart the auto store again.

Automatic Tuning System (ATS)

If the transmitter or cable network sends an automatic sort signal, the programmes are numbered correctly. In this case, the installation is complete. If an automatic sort signal is not available, you can use the **Sort** menu to number the programmes.

Automatic Channel Installation (ACI)

If a cable system or a TV channel that broadcasts ACI is detected, a programme list appears. If ACI is not available, the channels are numbered according to your selected language and country. If ACI is not available, you can use the **Sort** menu to renumber the channels.

Note: You cannot change the language or country in analogue mode. To change the language or country, exit the analogue mode and enter the digital mode. For more information, see *Selecting your language and location* on page 14.

Tuning analogue channels manually

You can tune analogue channels manually, one at a time.

1. If you are in digital mode, switch to analogue mode by pressing the **A/D** key on the remote control.

2. Press the **ANALOG MENU** key to display the **Main** menu.

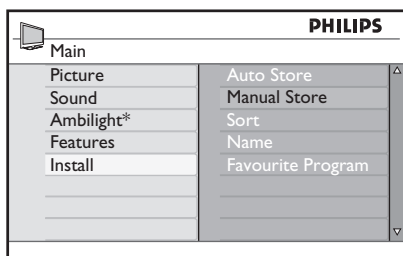

* Available in selected models

3. Press the **▲** or **▼** key to select **Install**, and press the **▶** or **OK** key to enter the **Install** menu.
4. Select **Manual Store**, and then press the **▶** or **OK** key to enter the **Manual Store** menu.

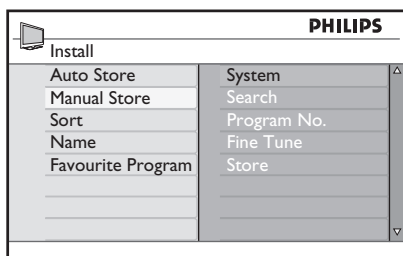

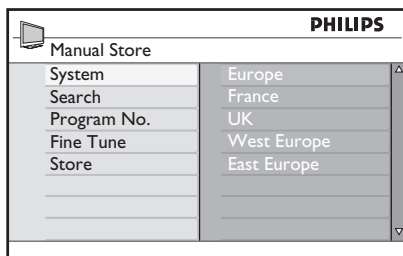

5. Press the **▲** or **▼** key to select items in the **Manual Store** menu.



6. Enter the **System** menu and select one of the following options:
 - **Europe** (automatic detection)
 - **France** (LL' standard)
 - **UK** (I standard)
 - **West Europe** (BG standard)
 - **East Europe** (DK standard)
7. Press the **▶** or **OK** key to confirm your selection.
8. Enter the **Search** menu and press the **▶** key to start a search. When a channel is found, the searching stops and if a channel name is available the name is displayed. Alternatively, enter the frequency of the required programme by pressing the **0** to **9** keys.
9. Enter the **Program No.** menu.
10. Press the **0** to **9** keys or the **▲** and **▼** keys to enter the number that you want to allocate to the channel.
11. If the reception is not satisfactory, enter the **Fine Tune** menu and press the **▲** or **▼** key to adjust the tuning.
12. Enter the **Store** menu and press the **▶** or **OK** key to store your changes. The channel is now stored.
13. Repeat the above steps for each channel that you want to store.
14. Press the **◀** key to return to the previous menu.
15. Press the **ANALOG MENU** key to exit the menu.

Renumbering channels

You can change the number that is allocated to a channel

1. Press the  key to display the **Main** menu.
2. Press the ▲ or ▼ key to select **Install**, and press the ► or  key to enter the menu.

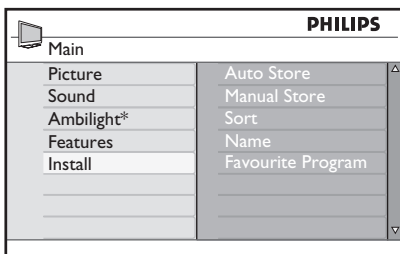

* Available in selected models

3. Press the ▲ or ▼ key to select **Sort**, and press the ► or  key to enter the menu.

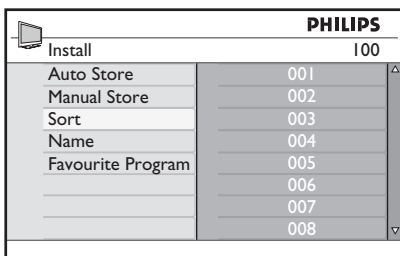

4. Press the ▲ or ▼ key to select the channel number you want to change.
5. Press the ► key to enter the sorting mode. Notice that the arrow cursor now points to the left.

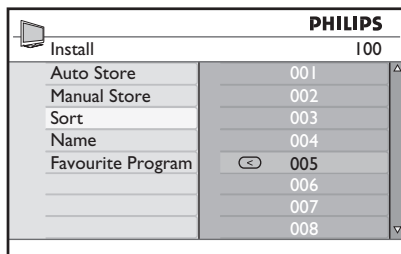

6. Press the ▲ or ▼ key to select the new channel number, and press the ◀ key to confirm your choice. Notice that the arrow cursor now points to the right.

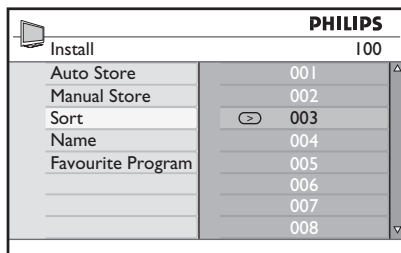





7. Repeat the above steps for each channel number that you wish to change.
8. Press the ◀ key to return to the previous menu.

9. Press the  key to exit the menu.



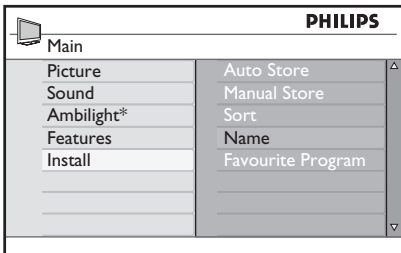

Naming channels

You can assign a name to a channel number.







1. Press the  key to display the **Main** menu.
2. Press the  or  key to select **Install**, and press the  or  key to enter the menu.

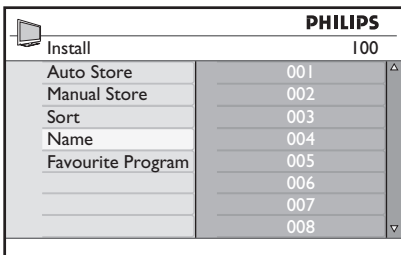





* Available in selected models

3. Press the  or  key to select **Name**, and press the  or  key to enter the menu.

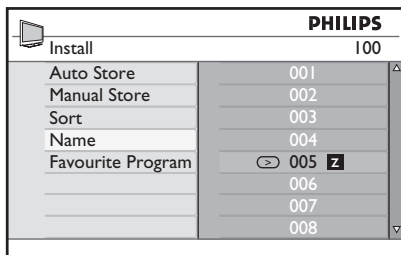

4. Press the  or  key to select the channel number you want to name.
5. Press the  key to enter the name area for that channel.
6. Press the  or  key to select the characters of the name.
 - You can use up to 5 characters in the name.
 - You can navigate the name area by pressing the  and  keys.



7. Press the  or  key to store the name. The name appears at the top left hand corner of the TV screen when it is stored.
8. Press the  key to return to the previous menu.
9. Press the  key to exit the menu.

Selecting your favourite channels

You can specify a list of favourite channels.

When you use the **P - / +** keys of the remote control to access channels, only the favourite channels are accessed.

To access channels that are not in your list of favourites, use the **0** to **9** numerical keys.

Adding or removing channels from your list of favourites

1. Press the **ANALOG (MENU)** key to display the **Main** menu.
2. Press the **▲** or **▼** key to select **Install**, and press the **▶** or **(OK)** key to enter the menu.

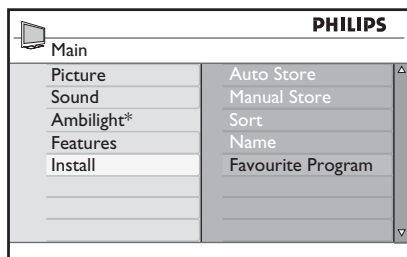

* Available in selected models

3. Press the **▲** or **▼** key to select **Favourite Program**, and press the **▶** or **(OK)** key to enter the menu.
4. Press the **▲** or **▼** key to select the channel number you want to add or remove from the list.

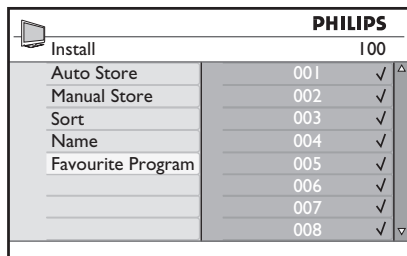

5. Toggle the **▶** or **(OK)** key to add or remove the channel from your list.
 - When the **✓** is displayed on the right of the menu, the channel is in the list of favourites.
 - When the **✓** is not displayed on the right of the menu, the channel is not in the list of favourites.

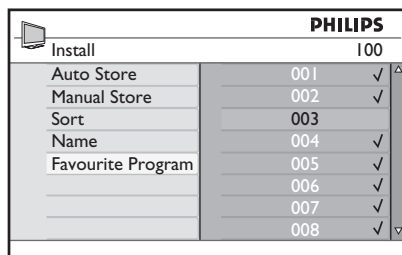





6. Press the **◀** key to return to the previous menu.
7. Press the **ANALOG (MENU)** key to exit the menu.

Setting the timer



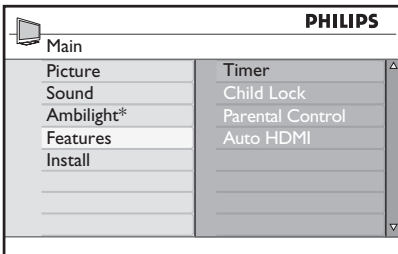

You can programme the TV to switch to another channel at a specified time or to switch on at a specified time from standby mode.

To operate the timer, you must leave the TV in standby mode.







1. Press the  key to display the **Main** menu.
2. Press the  or  key to select **Features**, and press the  or  key to enter the menu.

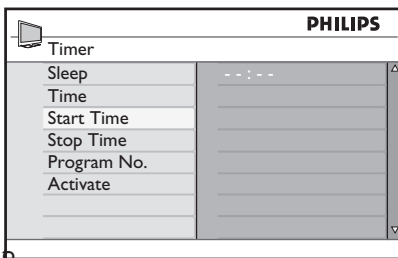

* Available in selected models

3. Press the  or  key to enter **Timer**.
4. Press the  or  key to select an option in the **Timer** menu.



5. Press the , , ,  keys or the  to  numerical keys to adjust the timer setting.
 - If you leave the TV in standby by pressing the  key, the TV will automatically come on at the programmed time.

- If you leave the TV set on, it will change channel at the **Start Time** and will go to standby at the **Stop Time**.





This list describes the options for the timer:

- **Sleep**
To select a time period after which the TV switches to standby mode. Select the **Off** option to deactivate the feature
Note: During the last minute of a sleep time setting, an on-screen countdown will be displayed. Press any button on the remote control to cancel the shut down.
- **Time**
To enter the current time.
- **Start Time**
To enter the time to start the timer. The TV will turn on from standby at this time or switch to another channel at this time.
- **Stop Time**
To enter the time to stop the timer. The TV will turn off at this time.
- **Program No.**
To enter the the channel number.
- **Activate**
The settings include:
 - **Off** to cancel
 - **Once** for a single alarm
 - **Daily** for each day

Blocking channels (Parental Control)



You can block TV channels to prevent your children from watching them.

Accessing the Parental Control menu

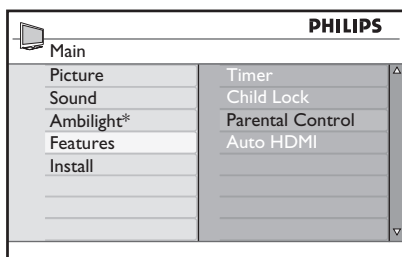
1. Press the  key to display the **Main** menu.
2. Press the  or  key to select **Features**, and press the  or  key to enter the menu.





* Available in selected models

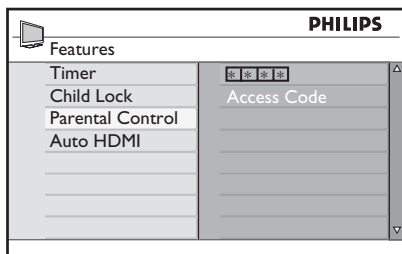

3. Press the  key to select the **Parental Control**, and press the  or  key to enter the menu.

Creating a pin code for parental control



1. Enter the Parental Control menu as described in *Accessing the Parental Control menu* above.



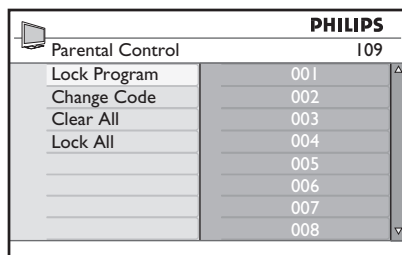

2. Key in the access code **0711** by using the  to  digit keys. The word **Incorrect** appears on the screen.

3. Key in the access code **0711** again. The TV prompts you to change the code.
4. Key in your own 4-digit code by using the  to  digit keys, and confirm the new code.





5. Press the  key to return to the previous menu.
6. Press the  key to exit the menu.

Blocking and unblocking selected channels

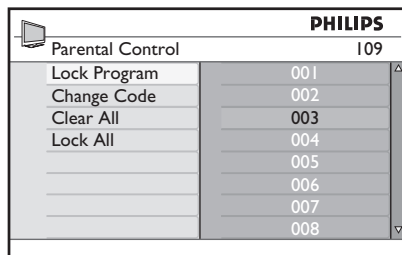
1. Enter the Parental Control menu as described in *Accessing the Parental Control menu* above.
2. Key in your access code by pressing the  to  digit keys. The **Parental Control** menu appears.
3. Press the  key to enter **Lock Program**.





4. Press the  or  key to select the channel to block or unblock.

Blocking channels (Parental Control) (cont.)

5. Press the ◀ or ▶ key to block or unblock the selected channel.

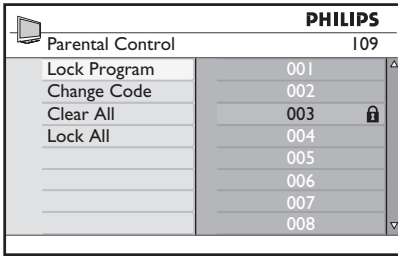
When a channel is blocked, a padlock symbol  appears besides the locked channel number.







PHILIPS	
Parental Control 109	
Lock Program	001
Change Code	002
Clear All	003 
Lock All	004
	005
	006
	007
	008

2. Press the ▼ key to select **Clear All** or **Lock All**.
3. Press ▶ key to enter **Clear All** or **Lock All** menu.
4. Press the ▶ key to clear all channels or lock all channels.

6. Press the ◀ key to return to the previous menu.

7. Press the  key to exit the menu.

Changing your pin code for parental control



1. Enter the Parental Control menu as described in *Accessing the Parental Control menu* on page 29.
2. Key in your own 4-digit code by using the  to  digit keys
3. Press the ▼ key to select **Change Code**.
4. Press ▶ key to enter the **Change Code** mode.
5. Key in the code by pressing the  to  keys.
6. Confirm the code by keying in the code again.

Blocking or unblocking all channels



1. Enter the Parental Control menu as described in *Accessing the Parental Control menu* on page 29.

Locking the side controls (Child Lock)

You can lock the side controls of the TV to prevent children from changing channels. However, it does not prevent you or your children from changing channel by using the remote control.

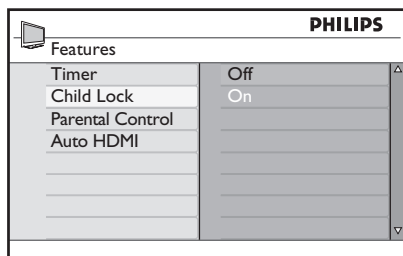
1. Press the  key to display the **Main** menu.
2. Press the **▲** or **▼** key to select **Features**, and press the **▶** or  key to enter the menu.
3. Press the **▼** key to select **Child Lock**, and press the **▶** or  key to enter the menu.





4. Press the **▲** or **▼** key to select **On** or **Off**.
5. Press the **▶** or  key to confirm your choice.
6. Press the **◀** key to return to the previous menu.
7. Press the  key to exit the menu.

Enjoying Ambilight

This section applies only to TVs equipped with the Ambilight feature.

Switching Ambilight on and off

1. Press the ^{ANALOG}  key to display the **Main** menu.
2. Press the **▲** or **▼** key to select **Ambilight**, and press the **▶** or  key to enter the menu.

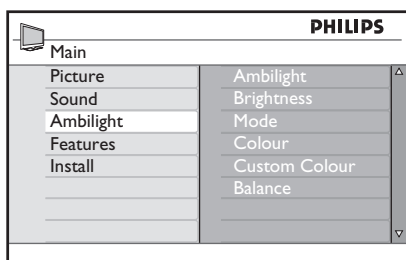

3. Press the **▲** and **▼** keys to select **On** or **Off**.

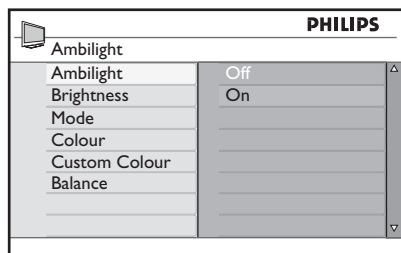



4. Press the **◀** key to return to the previous menu.
5. Press the ^{ANALOG}  key to exit the menu.

Configuring Ambilight settings

1. Perform steps 1 to 3 of the previous procedure to go to the **Ambilight** menu.
2. Press the **▲** and **▼** keys to select one of the following options: **Brightness**,

Mode, **Colour**, **Custom Colour** or **Balance**.



3. Press the **▶** or  key to confirm your choice.
4. Press the **▲** and **▼** keys to select the options for the feature.
5. Configure the option and press the **▶** or  key to confirm the configuration.

This list describes the Ambilight options:



- **Brightness**
To adjust the brightness of the Ambilight lamp.
- **Mode**
To select one of the following preset modes: Colour, Relaxed, Moderate and Dynamic.
- **Colour**
To select one of the following colour themes: Warm white, Cool white, Blue, Red, Green, Yellow, Magenta, Custom.
Note: This option appears only after you select *Colour* from the option *Mode* described above.
- **Custom Colour**
To set the colour saturation or palette.
Note: This option appears only after you select *Custom* from the option *Colour* described above.
- **Balance**
To adjust the colour intensity on the sides of the picture.

Adjusting picture and sound settings

You can adjust the picture and sound settings.

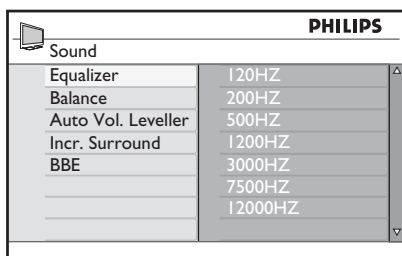
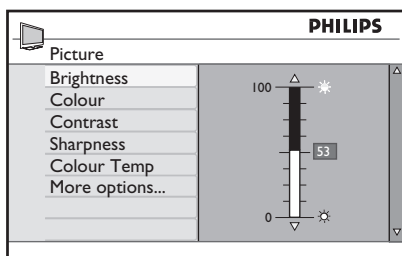
1. Press the  key to display the **Main** menu.
2. Press the **▲** or **▼** key to select **Picture** or **Sound**, and press the **▶** or  key to enter the menu.



3. Press the **▲** or **▼** key to select the a **Picture** or **Sound** setting, and press the **▶** or  key to enter the setting.
4. Press **▲** or **▼** key to adjust the **Picture** or **Sound** setting.
5. Press the **◀** key to return to the previous menu.
6. Press the  key to exit the menu.

Picture settings

This list describes the picture settings:

- **Brightness**
To change picture brilliance.

- **Colour**
To change the colour intensity.
- **Contrast**
To change difference between light and dark tones in the TV contrast range.
- **Sharpness**
To increases or decreases the sharpness.
- **Colour Temp**
To cycle through the following colour settings: Cool (more blue), Normal (balanced) and Warm (more red).
- **More options...**
 - **Contrast+**
To increase the contrast range of the TV. Select **On** to activate the Contrast+ feature.
 - **Active Control**
To adjust picture setting automatically for optimal picture quality under any signal conditions.
 - **Noise Reduction**
To reduce picture noise (white dots) due to weak signal transmission. Select **On** to activate the noise reduction feature.
 - **Artifacts Reduction**
To smoothen the transitions on digital content.
 - **Dig. Natural Motion**
To eliminate juddering effects on moving pictures.

Sound settings

This list describes the sound settings:

- **Equalizer**
To adjust the sound tone.
- **Balance**
To balance the sound on the left and right speakers.

Adjusting picture and sound settings (cont.)

- Automatic Volume Leveller
To limit sudden increases in volume, especially during programme changes or advertising slots.
- Incr. Surround
 - Select between **Incredible Surround** and **Stereo** when in stereo transmission.
 - Select between **Mono** and **Spatial** when in mono transmission.
- BBE (High definition sound)
To restore clarity and presence for better speech intelligibility and musical realism.

Using Smart Picture and Smart Sound

Using Smart Picture

You can toggle through a selection of predefined picture settings. Press the  button to cycle through the settings.

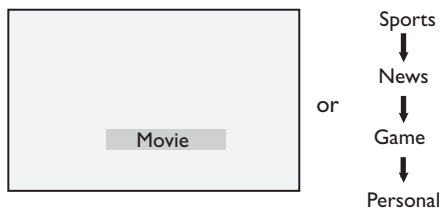

The **Personal** setting is the setting that you create by using the **Picture** menu in the **Main** menu. This is the only **Smart Picture** setting that can be changed. All other settings are pre-set.

This list summarizes the smart picture options;

- **Movie**
Brilliant and razor sharp picture settings suitable for cinematic experience.
- **Sports**
Ideal for enjoying your favourite sports programmes and natural settings.
- **News**
Suitable for viewing in a dim lighting and dim environment with a relaxed atmosphere.
- **Game**
For PCs, games consoles, playstations etc.
- **Personal**
The customised settings you defined by using the **Picture** menu in the **Main** menu.

Using Smart Sound

You can toggle through a selection of predefined sound settings. Press the  button to cycle through the settings.

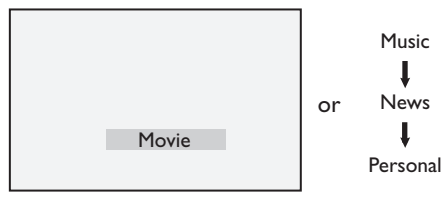

The **Personal** setting is the setting that you create by using the **Sound** menu in the **Main** menu. This is the only **Smart Sound** setting that can be changed. All other settings are pre-set.

This list summarizes the smart sound options;

- **Movie**
Cinematic sound sensation using incredible surround with subwoofer.
- **Music**
Crisp, clear riveting music that enhances your audible senses.
- **News**
High quality audio that emphasises life and depth in sound.
- **Personal**
The customised settings you defined by using the **Sound** menu in the **Main** menu.

Picture Formats

Pictures can be transmitted in various format. Toggle the  key to cycle through the picture formats and select your preferred viewing format.

Widescreen

The picture is displayed in the original proportions of images transmitted in 16:9 format.

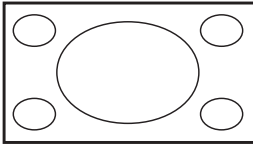

Note: If you display a 4:3 picture in widescreen mode, the picture is stretched horizontally.

4:3

The picture is reproduced in 4:3 format and a black band is displayed on either side of the picture.

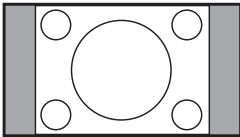

Movie expand 14:9

The picture is shown in 14:9 format. A thin black band remains on both sides of the picture and the top and bottom of the picture is clipped off.

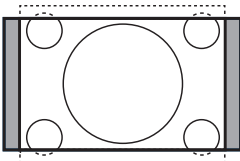

Movie expand 16:9

The picture is enlarged to 16:9 format. This mode is recommended when displaying pictures with black bands at the top and bottom (letterbox format). In this mode, large parts of the top and the bottom of the picture are clipped off.

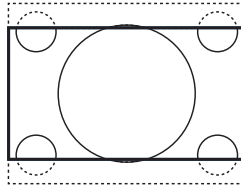

Subtitle Zoom

This mode is used to display 4:3 pictures using the full surface of the screen leaving the sub-titles visible. Part of the top of the picture is clipped off.

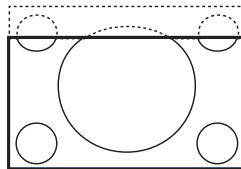

Super Zoom

This mode is used to display 4:3 pictures using the full surface of the screen by enlarging the sides of the picture.

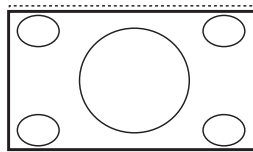

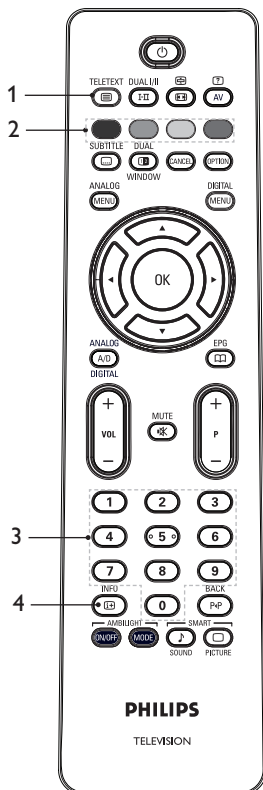

Using teletext

Teletext is an information system that is broadcast by some channels. Teletext can be consulted like a newspaper. It also offers access to subtitles for viewers with hearing problems or who are not familiar with the transmission audio language.



- 1. Teletext On/Off** 

To switch the teletext display **on** or **off**. A contents page appears with a list of items that can be accessed. Each item has a corresponding 3-digit page number. If the selected channel does not broadcast teletext, the indication 100 is displayed and the screen remains blank. To exit teletext, press the  key again.
- 2. Direct access** 

To access items directly. The colour areas are displayed at the bottom of the screen. The colour areas flash when the item or the page is not yet available.
- 3. Selecting a page** 

To enter the number of a teletext page. For example, to access page 120, enter 120. The number is displayed at the top left corner of the screen. When the page is located, the counter stops searching and the page is displayed. Repeat this operation to view another page. If the counter continues to search, the page is not being transmitted. When this happens, select another number.
- 4. Contents** 

To return to the content page. The content page is usually page 100 or hit list menu.

Using teletext (cont.)

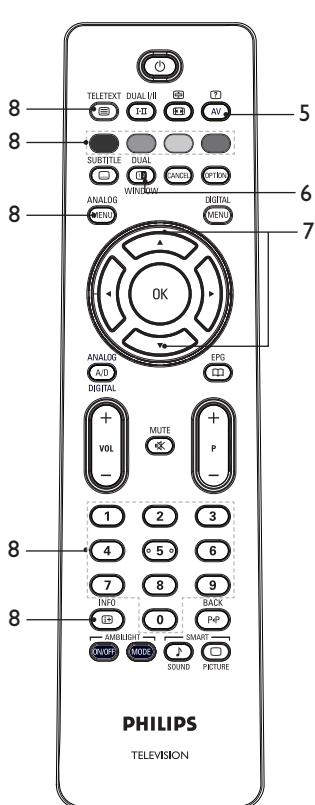

5. Hidden information

To display or hide the concealed information such as solutions to games or riddles.

6. TV picture/Teletext

Press and hold the  key to enter teletext mode.

Press the  key to show teletext on the right and the TV picture on the left of the screen.

Press the  key to return to a full TV picture.









- Press the  key to return to a full teletext page.

6. Enlarge a page

To display the top or bottom part of the page. Pressing again will return the page to normal size.

8. Favourite pages

To display your favourite page. This option is available in analogue mode only. The favourite pages can be accessed by pressing the colour keys. Once set, the favourite pages become the default every time teletext is selected. To store the favourite pages, proceed as follows:

- Press the  key to switch the teletext display on.
- Press the  key to change to favourite page mode.
- Use the  to  keys to enter the teletext page that you want to store as a favourite page.
- Press and hold the colour key of your choice for 5 seconds. The page number appears in the colour area and page is now stored.
- Repeat for above steps for the other colour keys.
- To exit favourite page mode, press the  key.
- To exit teletext mode, press the  key.
- To clear Favourite pages, go into  favourite pages by pressing the  key for about 5 seconds.

Using the TV in High Definition mode

Connecting HD equipment to your TV

1. Connect the HDMI or DVI output of your HD equipment to any of the HDMI connectors of the TV. Use a HDMI to DVI cable or a HDMI to HDMI cable.

Alternatively, you can connect the YPbPr output of your HD equipment to the Component Video Input of your TV.

2. If you are using a HDMI to DVI cable, connect the audio connector of the HD equipment to the L or R audio connectors at the side of the TV.
3. Press the **AV** key to display the Source List
4. Press the **▲** or **▼** key to select the correct HDMI source.

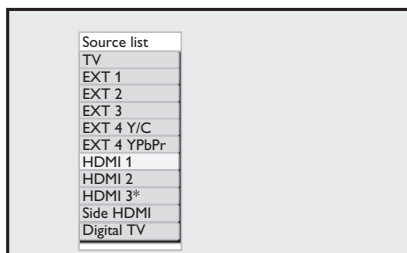

* Available in selected models

5. Press the **▶** or **OK** key to confirm the selected source.

Adjusting picture or sound settings in HD mode

1. Press the **MENU** key to display the **Main** menu.
2. Press the **▲** or **▼** key to select **Picture** or **Sound**, and press the **▶** or **OK** key to enter the menu.
3. Press the **▲** or **▼** key to select the **Picture** or **Sound** setting, and press the

▶ or **OK** key to enter the menu.

4. Press the **▲** or **▼** key to adjust the **Picture** or **Sound** setting.
5. Press the **◀** key to return to the previous menu.
6. Press the **MENU** key to exit the menu.

Picture settings in HD mode

Except for the Horizontal Shift and the Vertical Shift features, all of the picture settings in PC mode are the same as the picture settings in TV mode.

- Horizontal Shift
To adjust horizontal position of the image.
- Vertical Shift
To adjust vertical position of the image.

Sound settings in HD mode

All of the sound settings in HD mode are the same as the sound settings in TV mode.

Configuring the TV in HD mode

You must configure the TV in HD mode when you connect a HD equipment that supports the following resolutions: 480p, 720p, 1080i or 1080p.

The **Features** menu includes the **Mode Selection** option and the **Format** option.

1. Press the **MENU** key to display the **Main** menu.
2. Press the **▲** or **▼** key to select **Features**, and press the **▶** or **OK** key to enter the menu.
3. Press the **▼** key to select **Mode Selection**, and press **▶** or **OK** key to enter the setting.

Using the TV in High Definition mode (cont.)

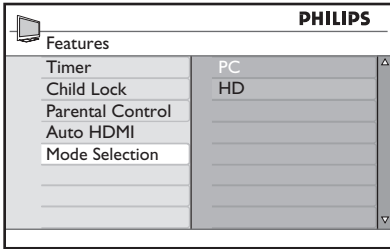



4. Press the ▲ or ▼ key to select **HD**.
5. Press the ◀ key to return to the previous menu.

6. Press the  key to exit the menu.

Displaying in native 1080 mode

Note: Only TVs with the full HD 1080p can display in native 1080p mode.

When you connect HD equipment that supports a resolution of 1080i or 1080p, the **Display (native 1080)** feature is available in the **Features** menu. This feature allows you to watch the original HD format in 1080i & 1080p mode.

1. Press the  key to display the **Main** menu.
2. Press the ▲ or ▼ key to select **Features**, and press the ▶ or  key to enter the menu.
3. Press ▼ key to select **Display**.

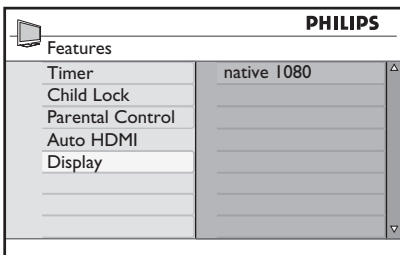

4. Press the ▶ key to access **Display** mode.
5. Press the ▶ key twice to access the **Off/On** option in the **native 1080**.

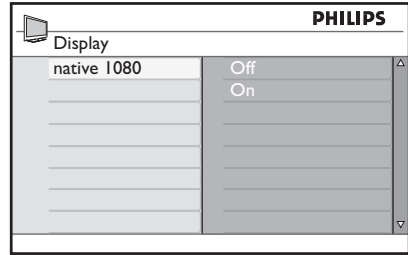

6. Press the ▲ ▼ keys to select **Off** or **On**. Select **On** option to watch native 1080mode.
7. Press the ◀ key to return to the previous menu.
8. Press the  key to exit the menu.

Supported formats

The following tables list the supported formats for HD mode.

HD	720p	1080p	1080i
SD	480i	576i	





Note: Your Philips TV is HDMI compliant. If you do not get a good picture, please change the video format on your peripheral devices. For example, for DVD player, select 480p, 576p, 720p, 1080i or 1080p. This is not a defect of the TV set.

Using the TV in High Definition mode (cont.)

Using Auto HDMI





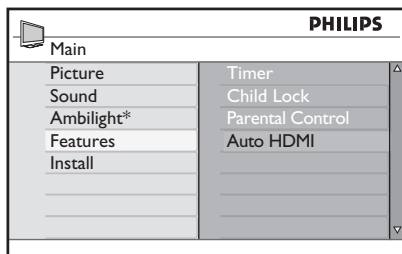

The first time you connect a device on an HDMI connection, the TV switches automatically to that HDMI channel. The TV does not switch automatically for subsequent HDMI connections.

Switching Auto HDMI off

1. Press the  key to display the **Main** menu.
2. Press the  or  key to select **Features**, and press the  or  key to enter the menu.



* Available in selected models

3. Press the  key to select **Auto HDMI**, and press the  or  key to enter the menu.
4. Press the  or  key to select **Off**.
5. Press the  or  key to confirm your choice.

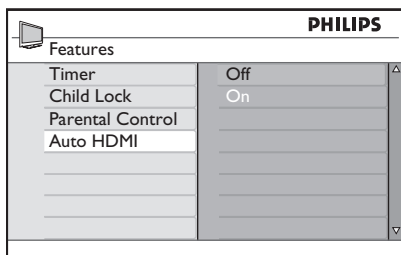

6. Press the  key to return to the previous menu.

7. Press the  key to exit the menu.

HDMI 1.3a CEC

Your TV is enabled for HDMI-CEC connections with other devices. The following descriptions apply to devices that are CEC-compliant and connected to your TV through an HDMI cable.

One-touch play

When you connect your TV to devices that support one-touch play, you can control your TV and the devices with one remote control. For example, when you press one-touch play on your DVD remote control, your Philips TV will automatically switch to the correct channel to show the DVD content.

Standby

When you connect your TV to devices that support standby, you can use your TV's remote control to put the devices into standby. To put a device into standby, press and hold the  button on the TV's remote control for 3-4 seconds.

Using the TV as a PC Monitor

You can use your TV as a PC monitor, by connecting the HDMI or DVI output of your PC to any of the HDMI connectors of the TV. Use an HDMI to DVI cable or an HDMI to HDMI cable. Connection through VGA is not supported.

When you use an HDMI connector to connect your PC to the TV, you might have to change the resolution or settings of the PC. You might see a dialogue box on screen and need to press "OK" to continue watching the TV. Refer to the manual of the PC for information about how to change the resolution or settings of the PC.

Connecting a PC to your TV

1. Connect the HDMI or DVI output of your PC to any of the HDMI connectors of the TV. Use an HDMI to DVI cable or an HDMI to HDMI cable.
2. If you are using a HDMI to DVI Cable, connect the audio connector of the PC to the L or R audio connectors at the side of the TV.
3. Press the **AV** key to display the **Source List**.
4. Press the **▲** or **▼** key to select the correct HDMI source.

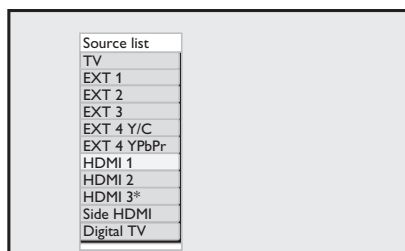

* Available in selected models

5. Press the **▶** or **OK** key to confirm the selected source.

Adjusting picture or sound settings in PC mode

For information about how to adjust picture or sound settings in HD mode, follow the procedure in *Adjusting picture or sound settings in HD mode* on page 39.

Picture settings in PC mode

The picture settings in HD mode are the same as those describe in *Picture settings in HD mode* on page 39.

Sound settings in PC mode

The sound settings in PC mode are the same as the sound settings in TV mode.

Configuring the TV in PC mode

For information about how to configure the TV in PC mode, follow the procedure in *Configuring the TV in HD mode* on page 39. In the procedure, select PC instead of HD.

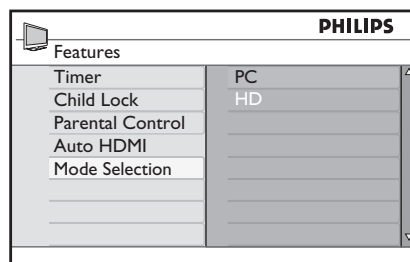















Supported PC resolutions

The following screen resolutions are supported.





640 x 480, 60 Hz	1024 x 768, 60 Hz
640 x 480, 72 Hz	1024 x 768, 70 Hz
640 x 480, 75 Hz	1024 x 768, 75 Hz
640 x 480, 85 Hz	1024 x 768, 85 Hz
800 x 600, 60 Hz	1280 x 768, 60 Hz
800 x 600, 72 Hz	1280 x 1024, 60 Hz
800 x 600, 75 Hz	1360 x 768, 60 Hz
800 x 600, 85 Hz	

Troubleshooting

Below is a list of symptoms you may encounter with your TV. Before you call for service, make these simple checks.

Symptom	Possible solutions
No display on screen	<ul style="list-style-type: none"> • Check whether power cord is properly connected to the mains socket and to your TV. If there is still no power, disconnect the plug. Wait for 60 seconds and re-insert the plug. Switch the TV on again. • Press the  key on the remote control.
Poor reception (snowy noise)	<ul style="list-style-type: none"> • Check the aerial connection to the TV and to the wall aerial socket. • Try manually adjusting your picture (see page 24). • Have you chosen the right TV system? (see to page 24).
No picture	<ul style="list-style-type: none"> • Verify the supplied cables are connected properly (The aerial cable to the TV, the other aerial to your recorder, the power cables,....). • Verify you have selected the correct source. • Verify whether the child lock has been switched off.
No sound on certain channels	<ul style="list-style-type: none"> • Check whether the correct TV system is selected (see page 24).
No sound	<ul style="list-style-type: none"> • Verify that the volume is not at the minimum. • Check that the mute () mode is not on. If mute mode is on, press the  key to deactivate mute mode. • Verify the connections between the peripheral equipment and the TV.
Sound interference	<ul style="list-style-type: none"> • Try switching off any electrical appliances to prevent interference, for example, hairdryer, vacuum cleaner.
Unable to understand the selected language on screen to operate set in digital mode	<ul style="list-style-type: none"> • Press the  key to exit menu from screen • Press the  key again to display menu. • Press the  key to select the second item on the menu. Press the  key to enter into the next menu level. • Press the  key again. Press the  key to select the fifth menu item. • Press the  key to enter into the next menu level. • Press the  or  key to select correct language. • Press the  key to confirm your selection. • Press the  key to exit menu.
TV not responding to remote control	<ul style="list-style-type: none"> • Move closer to the sensor at the front of the TV. • Check the placement of the batteries. • Change the batteries.

Troubleshooting (cont.)

Symptom	Possible solutions
No digital channels	<ul style="list-style-type: none"> Contact your dealer about the Digital Video Broadcasting Terrestrial signal availability in your country.
One or a few tiny spots on the screen that do not change colour along with the video picture	<ul style="list-style-type: none"> This symptom is not a problem. The liquid crystal panel is built with very high precision technology giving you the fine picture details. Occasionally, a few non-active pixels may appear on the screen as a fixed point of red, blue, green or black. Note: this does not affect the performance of the set.
Intermittent or flickering picture in HD mode	<ul style="list-style-type: none"> Noise is displayed when the connected equipment such as DVD player or set-top box fails. Check the user manual of the digital equipment you are connecting. Use a standard-compliant HDMI - DVI/HDMI - HDMI cable.
No sound or picture but front panel red light is on	<ul style="list-style-type: none"> Press the  key on the remote control.
PC modes do not work	<ul style="list-style-type: none"> Check whether the connections are correct. Check whether the source is correctly selected. Press the  button to enter the Source list and select the correct source. Check whether you have configured the computer to a compatible display resolution. Check the graphic card setting of PC.
S-Video colour becomes faint	<ul style="list-style-type: none"> Check whether the SVHS cable is properly connected. Press the P + key on the remote control to change channel and then press the P - key to change back again.
Black bar on top and bottom of screen in PC mode	<ul style="list-style-type: none"> Change the PC refresh rate to 60 Hz.
AC3 not available	<ul style="list-style-type: none"> AC3 is not supported for this set. Press the  key on the remote control to select an alternative audio.
TV aerial cannot be powered by set	<ul style="list-style-type: none"> Some TV aerials need to be powered by the set. This set does not support this feature.
Changing from one channel to another channel takes a long time	<ul style="list-style-type: none"> Pay TV channels are encoded by the cable provider and take a longer time to decode. This is normal behaviour and no action is required.
Cannot access digital menu	<ul style="list-style-type: none"> Check whether the TV is in analogue mode. If it is, press the  key to switch to digital mode.

Environmental Information



Recycling

The packaging of this product is intended to be recycled. Contact your local authorities for information about how to recycle the packaging.



Disposal of your old product

Your product is manufactured with high-quality materials and components which can be recycled and reused. When you see the crossed-out wheel bin symbol attached to a product, it means the product is covered by the European Directive 2002/96/EC.

Please familiarise yourself about your local systems for the disposal of electrical and electronic products. Please act according to your local regulations and do not dispose your old products with your normal household waste. The correct disposal of your old product will help to prevent potential negative consequences for the environment and for human health.

Disposal of batteries

The supplied batteries do not contain the heavy metals, mercury and cadmium. Please dispose off exhausted batteries according to your local regulations.

Power consumption

- This TV consumes minimal energy in standby mode to minimise environmental impact.
- Active power consumption is given on the type plate at the rear of the TV.

For more product specifications, see the product leaflet on www.philips.com/support.

Note: Specifications and information are subject to change without notice.



For further assistance, call the customer support service in your country. The telephone numbers and addresses are given in the worldwide guarantee booklet supplied with the TV.

Electric, Magnetic and Electromagnetic Fields (EMF)

- Royal Philips Electronics manufactures and sells many products targeted at consumers, which, like any electronic apparatus, in general have the ability to emit and receive electromagnetic signals.
- One of Philips' leading Business Principles is to take all necessary health and safety measures for our products, to comply with all applicable legal requirements and to stay well within the EMF standards applicable at the time of producing the products.
- Philips is committed to develop, produce and market products that cause no adverse health effects.
- Philips confirms that if its products are handled properly for their intended use, they are safe to use according to scientific evidence available today.
- Philips plays an active role in the development of international EMF and safety standards, enabling Philips to anticipate further developments in standardization for early integration in its products.



© 2007 Koninklijke Philips N.V.

All rights reserved

Document order number: 3139 125 38912