

Register your product and get support at

www.philips.com/welcome

47PFL4606H

46PFL5606H

42PFL4x06H

42PFL3x06H

40PFL5xx6H

37PFL4606H

32PFL5x06H

32PFL4606H

32PFL3x06H

26PDL49x6H

22PDL49x6H

DesignLine Tilt

EN User manual

PHILIPS

EN	Addendum When you select a channel from the channel grid, a preview is not displayed.	HR	Dodatak Kada odaberete kanal s mreže kanala, pretpregled se ne prikazuje.
BG	Допълнение Когато изберете канал от мрежата с канали, на дисплея не се показва преглед.	HU	Függelék A mikor kijelöl egy csatornát a csatornák táblázatában, nem jelenik meg előnézeti kép.
CS	Dodatek Při výběru kanálu z mřížky není náhled zobrazen.	IT	Integrazione Quando si seleziona un canale dalla relativa griglia, l'anteprima non viene visualizzata.
DA	Tillæg Når du vælger en kanal fra kanaloversigten, er der ikke nogen eksempelvisning.	KK	Қосымша Арналар кестесінен арна таңдалғанда алдын ала қарау мүмкіндігі болмайды.
DE	Nachtrag Wenn Sie einen Sender aus der Senderliste auswählen, wird keine Vorschau angezeigt.	LV	Pielikums Kad izvēlaties kanālu no kanālu tīkla, priekšskatījums netiek radīts.
EL	Παράρτημα Όταν επιλέγετε ένα κανάλι από το δίκτυο καναλιών, δεν εμφανίζεται προεπισκόπηση.	LT	Priedas Renkantis kanalą iš kanalų tinklelio, peržiūra nerodoma.
ES	Apéndice Cuando se selecciona un canal de la parrilla, no se muestra una vista previa.	NL	Addendum Wanneer u een zender selecteert in de zenderlijst, krijgt u geen voorbeeld te zien.
ET	Lisa Kui valite kanali kanalite tabelist, siis eelvaadet ei kuvata.	NO	Addendum Når du velger en kanal fra kanalnettet, vil forhåndsvisning ikke bli vist.
FI	Lisäys Kun valitset kanavan kanavaruudukosta, esikatselua ei näytetä.	PL	Dodatek Podgląd nie wyświetla się po wybraniu kanału z siatki kanałów.
FR	Addenda Lorsque vous sélectionnez une chaîne dans la grille des chaînes, aucun aperçu n'est disponible.	PT	Adenda Quando selecciona um canal na grelha de canais, não é apresentada uma pré-visualização.
		RO	Anexă Când selectați un canal din grila de canale, nu este afișată o imagine de examinare.

RU **Приложение**
При выборе канала из таблицы каналов предварительный просмотр не отображается.

SK **Príloha**
Keď vyberiete kanál z mriežky kanálov, ukážka sa nezobrazí.

SL **Dodatek**
Ko na seznamu kanalov izberete kanal, ni prikazan predogled.

SR **Dodatak**
Kada izaberete kanal iz mreže kanala, pregled se ne prikazuje.

SV **Tillägg**
När du markerar en kanal i kanalöversikten visas ingen förhandsgranskning.

TR **Ek**
Kanal izgarasından bir kanal seçtiğinizde, bir önizleme görüntülenmez.

UK **Додаток**
Під час вибору каналів з таблиці каналів попередній перегляд не відображається.

الملحق AR
عندما تختار قناة من قائمة شبكة القنوات، لا يتم عرض المعاينة.

Supported audio/video formats

File Extensions	Container	Video codec	Maximum resolution	Max. Frame Rate (fps)	Max. Bit Rate (Mbps)	Audio codec	USB	DLNA
.mpg .mpeg .vob	PS	MPEG1	768x576	30	1.8 Mbps	MPEG1 Layer1/2, MP3, AC3, DVD LPCM	YES	YES
		MPEG2 MP@HL	1920x1080	30	40 Mbps		YES	YES
		MPEG2 MP@HL	1920x1080	30	40 Mbps		YES	YES
.ts	TS	VC-1	1920x1080	30	40 Mbps	MPEG1 Layer1/2, AC3 MPEG2 AAC-LC, MPEG4 AAC-LC/ HE-AAC, AC3	YES	YES
		H.264 BP/MP/HP LV 4.0	1920x1080	30	40 Mbps		YES	YES
		H.264 BP/MP/HP LV 4.0	1920x1080	30	40 Mbps		YES	YES
		MPEG4 SP@L 3.0/ ASP@HL 4.0	1920x1080	30	40 Mbps		YES	YES
.mp4 (.mov and .3gpp extensions are not supported)	MP4	H.263	1408x1152	30	40 Mbps	MPEG1 Layer1/2, MP3, MPEG2 AAC-LC, MPEG AAC-LC/HE-AAC	YES	YES
		Motion JPEG (*mov only)	1280x720	30	30 Mbps		YES	YES
		H.264 BP/MP/HP LV 4.0	1920x1080	30	40 Mbps		YES	YES
		MPEG4 SP@L 3.0/ ASP@HL 4.0	1920x1080	30	40 Mbps		YES	YES
.mkv	MKV	WMV9	1920x1080	30	40 Mbps	wav/PCM/ADPCM/A-law PCM/u-law PCM, MPEG1 Layer1/2, MP3, MPEG2 AAC-LC, MPEG AAC-LC/HE-AAC, AC3, WMVA8	YES	YES
		VC-1	1920x1080	30	40 Mbps		YES	YES
		XviD	1920x1080	30	40 Mbps		YES	YES
		MPEG1	768x576	30	1.8 Mbps		YES	YES
.mp4 .avi	AVI	MPEG2 MP@HL	1920x1080	30	40 Mbps	wav/PCM/ADPCM/A-law PCM/u-law PCM, MPEG1 Layer1/2, MP3, MPEG2 AAC-LC, MPEG AAC-LC/HE-AAC, AC3, WMVA8	YES	YES
		H.264 BP/MP/HP LV 4.0	1920x1080	30	40 Mbps		YES	YES
		MPEG4 SP@L 3.0/ ASP@HL 4.0	1920x1080	30	40 Mbps		YES	YES
		Motion JPEG	1280x720	30	30 Mbps		YES	YES
.flv	FLV	Sorenson	352x288	30	40 Mbps	MPEG1 Layer1/2, MP3, MPEG2 AAC-LC, MPEG AAC-LC/HE-AAC	YES	YES
		H.264 BP/MP/HP LV 4.0	1920x1080	30	40 Mbps		YES	YES
.mp3	MP3	NA	NA	NA	32/40/48/56/64/80/96/ 112/128/160/192/224/ 256/320 kbits/s	MP3	YES	YES
.wav	MKV	NA	NA	NA	16bit PCM(big/little endian) 24bit PCM(big endian)	PCM/ADPCM/A-law PCM/ u-law PCM	YES	YES
.aac .mp4 .mha	AAC	NA	NA	NA	16-576 kbits/s	ACC-LC/HE-AAC	YES	YES

Contents

1	Notice	2
----------	---------------	----------

2	Important	4
----------	------------------	----------

3	Your TV	7
	TV controls	7
	Remote control	8
	Remote control usage	9

4	Use your TV	10
	Switch your TV on	10
	Switch your TV to standby	10
	Switch your TV off	11
	Switch channels	11
	Watch connected devices	12
	Adjust TV volume	12
	Use teletext	13

5	Use more of your TV	14
	Access TV menus	14
	Add device to the home menu	14
	Rename devices from the home menu	14
	Remove devices from the home menu	15
	Change picture and sound settings	15
	Use the universal access menu	18
	Use advanced teletext features	19
	Create and use lists of favourite channels	20
	Use the Electronic Programme Guide	20
	Display the TV clock	21
	Use timers	22
	Lock unsuitable content	23
	View Scenea	24
	Change language	24
	Play photos, music and videos on USB storage devices	25
	Listen to digital radio channels	27
	Update the TV software	27
	Change TV preferences	29
	Start a TV demo	29
	Reset the TV to factory settings	29

6	Install channels	30
	Automatically install channels	30
	Manually install analogue channels	31
	Manually install digital channels	31
	Rename channels	31
	Rearrange channels	32
	Access CAM services	32

7	Connect devices	33
	Back connections	33
	Side connections	35
	Connect a computer	36
	Use a Conditional Access Module	37
	Use Philips EasyLink	38
	Use a Kensington lock	40

8	Product information	41
	Supported display resolutions	41
	Multimedia	41
	Tuner/Reception/Transmission	41
	Remote control	41
	Power	41
	Supported TV mounts	42
	Product specification	42

9	Troubleshooting	44
	General TV issues	44
	TV channel issues	44
	Picture issues	44
	Sound issues	45
	HDMI connection issues	45
	Computer connection issues	45
	Contact us	45

10	Index	46
-----------	--------------	-----------

1 Notice

2012 © TP Vision Netherlands B.V. All rights reserved.

Specifications are subject to change without notice. Trademarks are the property of Koninklijke Philips Electronics N.V. or their respective owners. TP Vision Netherlands B.V. reserves the right to change products at any time without being obliged to adjust earlier supplies accordingly.

The material in this manual is believed adequate for the intended use of the system. If the product, or its individual modules or procedures, are used for purposes other than those specified herein, confirmation of their validity and suitability must be obtained. TP Vision Netherlands B.V. warrants that the material itself does not infringe any United States patents. No further warranty is expressed or implied.

Terms of warranty

- Risk of injury, damage to TV or void of warranty! Never attempt to repair the TV yourself.
- Use the TV and accessories only as intended by the manufacturer.
- The caution sign printed on the back of the TV indicates risk of electric shock. Never remove the TV cover. Always contact Philips Customer Support for service or repairs.



- Any operation expressly prohibited in this manual, or any adjustments and assembly procedures not recommended or authorised in this manual shall void the warranty.

Pixel characteristics

This LCD product has a high number of colour pixels. Although it has effective pixels of 99.999% or more, black dots or bright points of light (red, green or blue) may appear constantly on the screen. This is a structural property of the display (within common industry standards) and is not a malfunction.

Compliance with EMF

TP Vision Netherlands B.V. manufactures and sells many products targeted at consumers which, like any electronic apparatus, in general have the ability to emit and receive electromagnetic signals.

One of Philips' leading Business Principles is to take all necessary health and safety measures for our products, to comply with all applicable legal requirements and to stay well within the Electro Magnetic Field (EMF) standards applicable at the time of producing the products.

Philips is committed to develop, produce and market products that cause no adverse health effects. TP Vision confirms that if its products are handled properly for their intended use, they are safe to use according to scientific evidence available today.

Philips plays an active role in the development of international EMF and safety standards, enabling Philips to anticipate further developments in standardisation for early integration in its products.

Mains fuse (UK only)

This TV is fitted with an approved moulded plug. Should it become necessary to replace the mains fuse, this must be replaced with a fuse of the same value as indicated on the plug (example 10A).

- 1 Remove fuse cover and fuse.
- 2 The replacement fuse must comply with BS 1362 and have the ASTA approval mark. If the fuse is lost, contact your dealer in order to verify the correct type.
- 3 Refit the fuse cover.

Copyright



® Kensington and Micro Saver are registered US trademarks of ACCO World corporation with issued registrations and pending applications in other countries throughout the world.



Manufactured under licence from Dolby Laboratories. Dolby and the double D symbol are trademarks of Dolby Laboratories.



HDMI, the HDMI logo and High-Definition Multimedia Interface are trademarks or registered trademarks of HDMI licensing LLC in the United States and other countries. All other registered and unregistered trademarks are the property of their respective owners.

2 Important

Read and understand all instructions before you use your TV. If damage is caused by failure to follow instructions, the warranty does not apply.

Safety

Risk of electric shock or fire!

- Never expose the TV to rain or water. Never place liquid containers, such as vases, near the TV. If liquids are spilt on or into the TV, disconnect the TV from the power outlet immediately. Contact Philips Consumer Care to have the TV checked before use.
- Never place the TV, remote control or batteries near naked flames or other heat sources, including direct sunlight. To prevent the spread of fire, keep candles or other flames away from the TV, remote control and batteries at all times.



- Never insert objects into the ventilation slots or other openings on the TV.
- When the TV is swivelled ensure that no strain is exerted on the power cord. Strain on the power cord can loosen connections and cause arcing.

Risk of short circuit or fire!

- Never expose the remote control or batteries to rain, water or excessive heat.
- Avoid force coming onto power plugs. Loose power plugs can cause arcing or fire.

Risk of injury or damage to the TV!

- Two people are required to lift and carry a TV that weighs more than 25 kg or 55 lbs.
- When stand mounting the TV, use only the supplied stand. Secure the stand to the TV tightly. Place the TV on a flat, level surface that can support the combined weight of the TV and the stand.
- When wall mounting the TV, use only a wall mount that can support the weight of the TV. Secure the wall mount to a wall that can support the combined weight of the TV and wall mount. TP Vision Netherlands B.V. bears no responsibility for improper wall mounting that result in accident, injury or damage.
- Parts of this product may be made of glass. Handle with care to avoid injury and damage.

Risk of injury to children!

Follow these precautions to prevent the TV from toppling over and causing injury to children:

- Never place the TV on a surface covered by a cloth or other material that can be pulled away.
- Ensure that no part of the TV hangs over the edge of the surface.
- Never place the TV on tall furniture (such as a bookcase) without anchoring both the furniture and TV to the wall or a suitable support.
- Educate children about the dangers of climbing on furniture to reach the TV.

Risk of swallowing batteries!

- The product/remote control may contain a coin-type battery, which can be swallowed. Keep the battery out of reach of children at all times!

Risk of overheating!

- Never install the TV in a confined space. Always leave a space of at least 4 inches or 10 cm around the TV for ventilation. Ensure curtains or other objects never cover the ventilation slots on the TV.

Risk of damage to the TV!

- Before you connect the TV to the power outlet, ensure that the power voltage matches the value printed on the back of the TV. Never connect the TV to the power outlet if the voltage is different.
- If you need to store the TV, disassemble the stand from the TV. Never lay the TV on its back with the stand installed.

Risk of injury, fire or power cord damage!

- Never place the TV or any objects on the power cord.
- To easily disconnect the TV power cord from the power outlet, ensure that you have full access to the power cord at all times.
- When you disconnect the power cord, always pull the plug, never the cable.
- Disconnect the TV from the power outlet and antenna before lightning storms. During lightning storms, never touch any part of the TV, power cord or antenna cable.

Risk of hearing damage!

- Avoid using earphones or headphones at high volumes or for prolonged periods of time.

Low temperatures

- If the TV is transported in temperatures below 5°C or 41°F, unpack the TV and wait until the TV temperature matches room temperature before connecting the TV to the power outlet.

Screen care

- Avoid stationary images as much as possible. Stationary images are images that remain on-screen for extended periods of time. Examples include: on-screen menus, black bars and time displays. If you must use stationary images, reduce screen contrast and brightness to avoid screen damage.
- Unplug the TV before cleaning.
- Clean the TV and frame with a soft, damp cloth. Never use substances such as alcohol, chemicals or household cleaners on the TV.
- Risk of damage to the TV screen! Never touch, push, rub or strike the screen with any object.
- To avoid deformations and colour fading, wipe off water drops as soon as possible.

Temperature and Humidity

In rare occasions, depending on temperature and humidity, minor condensation can occur on the inside of the glass front. To prevent this, do not expose the TV to direct sunlight, heat or extreme humidity. If condensation occurs, it will disappear spontaneously while the TV is playing for a few hours. The condensation moisture will not harm the TV or cause malfunction.

Disposal of your old product and batteries



Your product is designed and manufactured with high quality materials and components, which can be recycled and reused.



When this crossed-out wheeled bin symbol is attached to a product it means that the product is covered by the European Directive 2002/96/EC. Please inform yourself about the local separate collection system for electrical and electronic products.

Please act according to your local rules and do not dispose of your old products with your normal household waste.

Correct disposal of your old product helps to prevent potential negative consequences for the environment and human health.



Your product contains batteries covered by the European Directive 2006/66/EC, which cannot be disposed of with normal household waste. Please inform yourself about the local rules on separate collection of batteries because correct disposal helps to prevent negative consequences for the environment and human health.

Environmental efforts

Philips continuously focuses on lowering the environmental impact of its innovative consumer products. We aim our efforts towards environmental improvements during manufacturing, reduction of harmful substances, energy-efficient use, end-of-life instructions and product recycling.

To access energy-efficient settings:

- 1 While you watch TV, press the green button on the remote control.
- 2 Select one of the following settings:
 - **[Energy saving]:** Picture settings that conserve the most energy.
 - **[Mute screen]:** If you only want to listen to audio from the TV, you can turn off the TV display. Other functions continue to operate normally.
 - **[Light sensor]:** The built-in ambient light sensor lowers the brightness of the TV screen when the surrounding light darkens.
 - **[Switch off unused sources]:** If you connect EasyLink-compliant devices, you can switch them off.

3 Your TV

Congratulations on your purchase, and welcome to Philips! To fully benefit from the support that Philips offers, register your TV at www.philips.com/welcome.

TV controls

- ① +/-: Adjust volume.
- ② (Home): Access the home menu.
- ③ CH +/-: Switch channels.
- ④ Power: Switch the TV on or off.

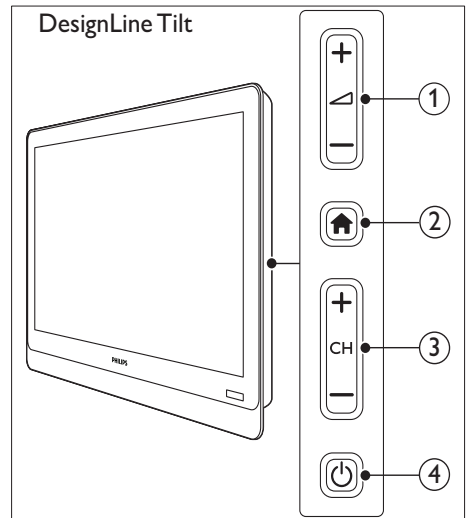
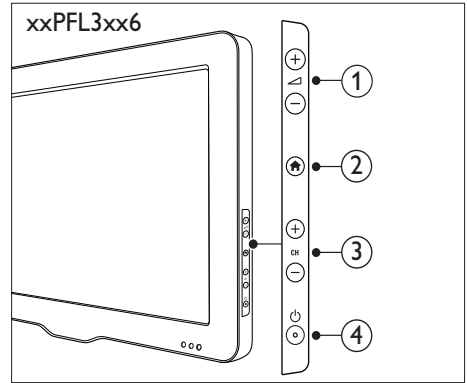
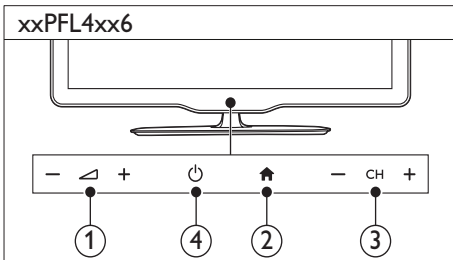
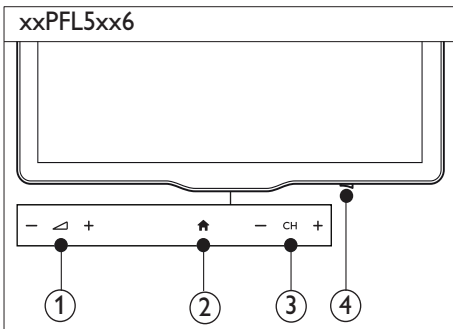

Remote control

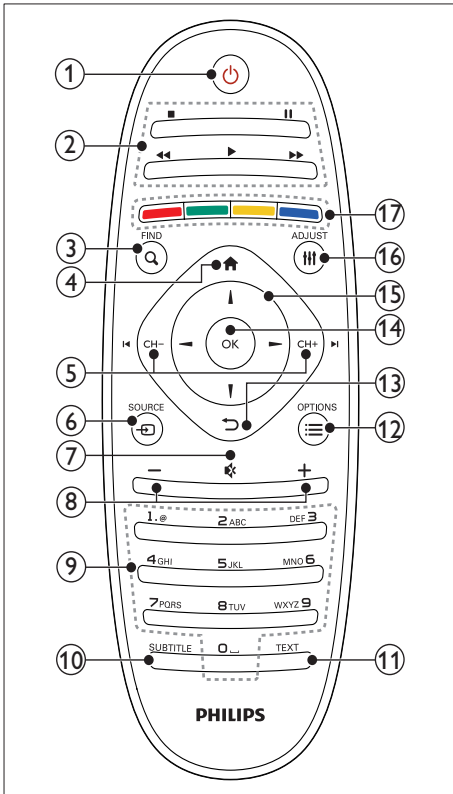

- ① **⏻ (Standby-On)**
 - Switch the TV on or to standby.
- ② **Play buttons**
 - Control video or music.
- ③ **Q FIND**
 - Access the menu to select a TV channel list.
- ④ **🏠 (Home)**
 - Access the home menu.
- ⑤ **⏮ CH - / CH + ⏭ (Previous/Next)**
 - Switch channels or navigate through menu pages, tracks, albums or folders.
- ⑥ **📺 SOURCE**
 - Select connected devices.

- ⑦ **🔇 (Mute)**
 - Mute or restore audio.
- ⑧ **+/- (Volume)**
 - Adjust volume.
- ⑨ **0-9 (Numeric buttons)**
 - Select channels.
- ⑩ **SUBTITLE**
 - Enable or disable subtitles.
- ⑪ **TEXT**
 - Enable or disable teletext.
- ⑫ **☰ OPTIONS**
 - Access options for the current activity or selection.
- ⑬ **↶ (Back)**
 - Return to the previous menu or exit a function.
- ⑭ **OK**
 - Confirm an entry or selection.
- ⑮ **▲▼▶◀ (Navigation buttons)**
 - Navigate through menus and select items.
- ⑯ **⋮ ADJUST**
 - Access the menu to adjust settings.
- ⑰ **Colour buttons**
 - Select tasks or options.

Remote control usage

When you use the remote control, hold it close to the TV and point it at the remote control sensor. Make sure that the line-of-sight between the remote control and TV is not blocked by furniture, walls or other objects.

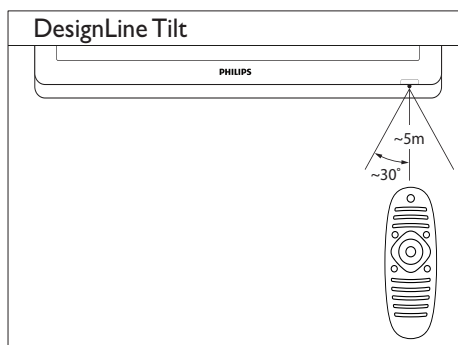
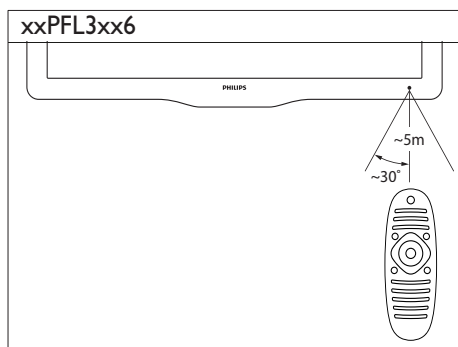
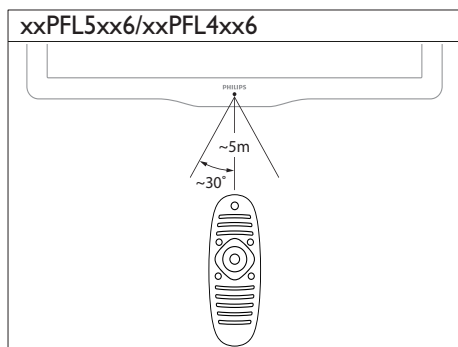

4 Use your TV

This section helps you perform basic TV operations.

Switch your TV on

- Press the power switch on the TV.
↳ There is a short delay before the TV responds.

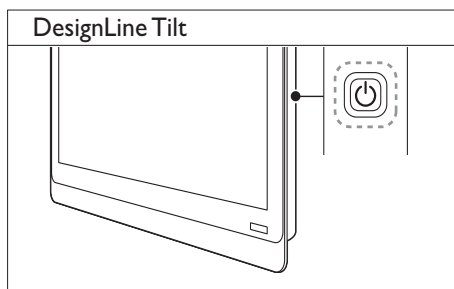
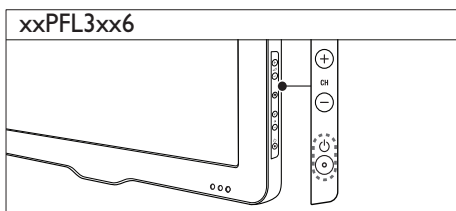
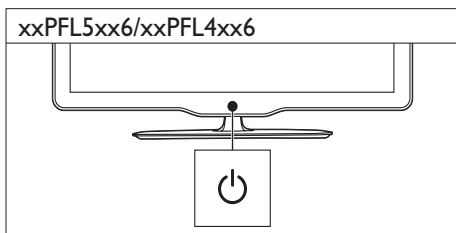
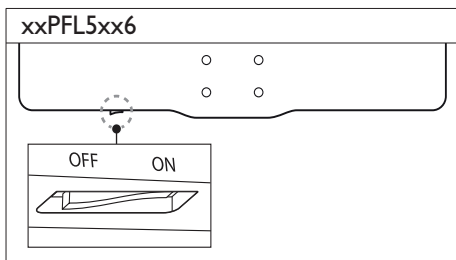

If the TV is in standby

- Press  (Standby-On) on the remote control.

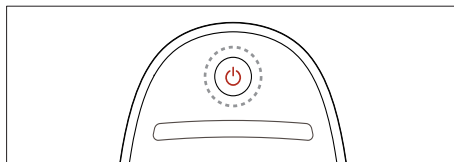

Switch your TV to standby

- Press  (Standby-On) on the remote control again.
↳ The remote control sensor on the TV switches to red.

Switch your TV off

- Press the power switch on the TV again.
 - ↳ The remote control sensor on the TV switches off.
 - ↳ For xxPFL5xx6, the TV no longer consumes energy.
 - ↳ For xxPFL4xx6, xxPFL3xx6, and DesignLine Tilt, though the TV consumes very little power when in standby, energy continues to be consumed. When not in use for an extended period of time, disconnect the TV power cable from the power outlet or turn off the power switch.

Note

- If you cannot locate your remote control and want to switch on the TV from standby, press **CH+/-** on the TV.

Switch channels

- Press **CH+** or **CH-** on the remote control.

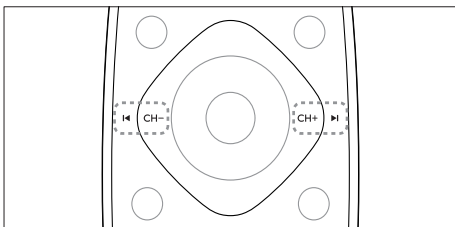

- Press **CH +/-** on the TV.

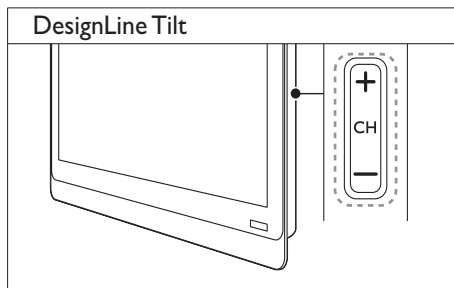
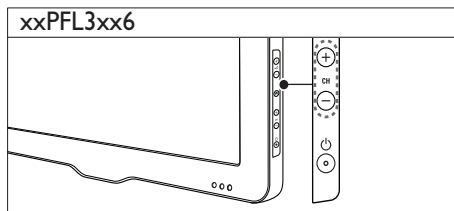
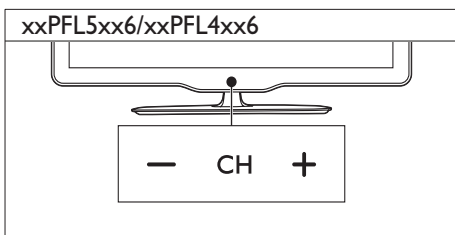

Other ways to switch channels

- Enter a channel number using the **Numeric buttons**.
- Press **↶ (BACK)** on the remote control to return to the previous channel.

Note

- When you use a favourite list, you can only select those channels in the list (see 'Create and use lists of favourite channels' on page 20).

View channel preview

You can view a preview of all available channels with the channel grid.

- Press **Q FIND**.
 - ↳ The channel grid appears.
 - ↳ To preview a channel, select it.
 - ↳ To watch a channel, select it, then press **OK**.

Watch connected devices

Note

- Before you select a device as a source, switch the device on.

Select a device from the source list

1 Press **SOURCE**.

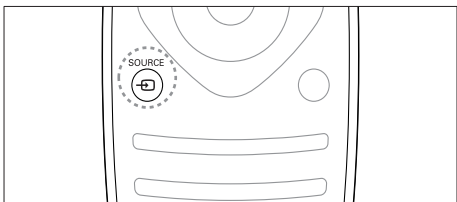

↳ The source list appears.

2 Press **▲▼** to select a device.

3 Press **OK** to confirm your choice.

↳ The TV switches to the selected device.

Adjust TV volume

- Press **+/-** on the remote control.

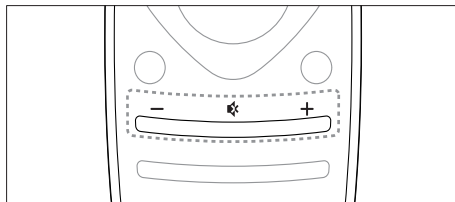

- Press **▲▼ +/-** on the TV.

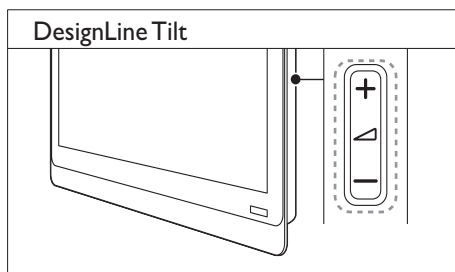
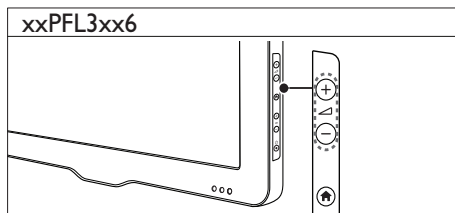
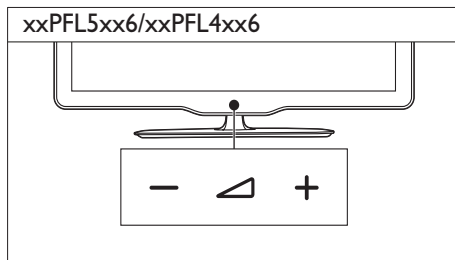

To mute or unmute sound

- Press **★** to mute the sound.
- Press **★** again to restore the sound.

Use teletext

1 Press **TEXT**.

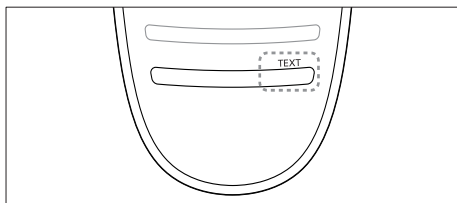

↳ The main index page appears.

- 2 Select a page with one of the following:
- Press the **Numeric buttons** to enter a page number.
 - Press **◀** or **▶** to view the next or previous page.
 - Press the **Colour buttons** to select a colour coded item.
 - Press **↶ (BACK)** to return to a previously viewed page.

3 Press **TEXT** to exit teletext.



Note

- For UK users only: Some digital TV channels offer dedicated digital text services (for example, BBC1).

5 Use more of your TV

Access TV menus

Menus help you to install channels, change picture and sound settings and access other features.

- 1 Press **▲**.
The menu screen appears.



- 2 Select one of the following, then press **OK**.
 - **[Watch TV]**: If a source other than antenna is selected, switch back to the antenna source
 - **[Programme guide]**: Access the electronic programme guide.
 - **[Browse USB]**: If a USB device is connected, access the content browser.
 - **[Scenea]**: Switch on Scenea wallpaper.
 - **[Add new device]**: Add new devices to the home menu.
 - **[Setup]**: Access menus to change picture, sound and other settings.
 - **[Help]**: Access the TV tour.
- 3 Press **▲** to exit.

Add device to the home menu

After you connect a device, add it to the home menu.

- 1 Press **▲**.
- 2 Select **[Add new device]**.
- 3 Follow the onscreen instructions to add the device to the home menu.
 - ↳ The device is displayed in the home menu.
- 4 To watch the device, switch it on, then select it in the home menu.
- 5 You can also select the device with the source button (see 'Select a device from the source list' on page 12).

Rename devices from the home menu

After you add a new device to the home menu, you can rename it to your preference.

Note

- The device name can be up to 16 characters long.

- 1 Press **▲**.
- 2 Select a device to rename.
- 3 Press **≡** **OPTIONS**.
 - ↳ The options menu appears.
- 4 Select **[Rename device]**, then press **OK**.
 - ↳ A text input box appears.
- 5 For each character in the device name, select a character; then press **OK** to confirm.
 - Press **[Aa]** to change uppercase letters to lowercase letters and vice versa.
- 6 When the new name is complete, select **[Done]**, then press **OK**.

Remove devices from the home menu

If a device is no longer connected to the TV, remove it from the home menu.

- 1 Press **▲**.
- 2 Select a device to remove.
- 3 Press **☰** **OPTIONS**.
- 4 Select **[Remove device]**, then press **OK**.
- 5 Select **[Remove]**, then press **OK**.
 - ↳ The selected device is removed from the home menu.

Change picture and sound settings

Change picture and sound settings to suit your preferences. You can apply pre-defined settings or change settings manually.



Note

- While you watch TV or external devices, press **⏏** **ADJUST**, then select **[Smart picture]** or **[Smart sound]** for quick access to picture and sound settings.

Use smart picture

Use smart picture to apply pre-defined picture settings.

- 1 Press **⏏** **ADJUST**.
- 2 Select **[Smart picture]**, then press **OK**.
- 3 Select one of the following settings, then press **OK**.
 - **[Personal]**: Apply your customised picture settings
 - **[Vivid]**: Rich and dynamic settings, ideal for daytime.
 - **[Natural]**: Natural picture settings.
 - **[Cinema]**: Ideal settings for movies.
 - **[Game]**: Ideal settings for games.
 - **[Energy saving]**: Settings that conserve the most energy.
 - **[Standard]**: Default settings that suit most environments and types of video.
 - **[Photo]**: Ideal settings for photos.
 - **[Custom]**: Customise and store your personal picture settings. Select **[Personal]** to apply these settings.

Use settings assistant

Use the settings assistant to guide you through the picture and sound settings.

- 1 Press **▲**.
- 2 Select **[Setup]** > **[Quick picture and sound settings]**, then press **OK**.
- 3 Select **[Continue]**, then press **OK**.
 - ↳ The **[Settings assistant]** menu appears.
- 4 Follow the onscreen instructions to choose your preferred picture settings.

Manually adjust picture settings

1 Press **▲**.

2 Select **[Setup]** > **[TV settings]** > **[Picture]**, then press **OK**.

3 Select one of the following settings, then press **OK**.

- **[Smart picture]**: Access predefined smart picture settings.
- **[Reset]**: Reset to factory default settings.
- **[Contrast]**: Adjust the intensity of backlight areas, while the video contents are kept unchanged.
- **[Brightness]**: Adjust the intensity and details of dark areas.
- **[Colour]**: Adjust colour saturation.
- **[Hue]**: Compensate for colour variations.
- **[Sharpness]**: Adjust sharpness in the image.
- **[Noise reduction]**: Filter and reduce noise in an image.
- **[Tint]**: Adjust the colour balance in an image.
- **[Custom tint]**: Customise tint setting. (Only available if **[Tint]** > **[Custom]** is selected)
- **[Digital Crystal Clear]** / **[Pixel Plus]** / **[Pixel Plus HD]**: Fine-tune each pixel to match surrounding pixels. This setting produces a brilliant, high-definition image.
 - **[HD Natural Motion]**: For selected models. Minimise juddering effects and enhance picture smoothness.
 - **[100Hz Clear LCD]** / **[120Hz Clear LCD]**: For selected models. Reduce motion blurring and make picture clearer.
 - **[Advance sharpness]**: Enable superior picture sharpness.
 - **[Dynamic contrast]**: Enhance contrast. **[Medium]** setting is recommended.
 - **[Dynamic backlight]**: Adjust brightness of the TV backlight to match lighting conditions.
 - **[MPEG artifact reduction]**: Smooth out transitions on digital pictures. You can switch this feature on or off.
- **[Colour enhancement]**: Make colours more vivid and improve the details in bright colours. You can switch this feature on or off.
- **[Gamma]**: For selected models. Adjust the midtone intensity in the picture. Black and white are not affected.
- **[PC mode]**: Adjust the picture when a PC is connected to the TV via HDMI or DVI.
- **[Light sensor]**: Adjust settings dynamically based on the current lighting conditions.
- **[Picture format]**: Change the picture format.
- **[Screen edges]**: Adjust the viewing area. (when set to maximum, you may see noise or the rough edge of an image).
- **[Picture shift]**: If available, adjust the picture position for all picture formats except for **[Auto zoom]** and **[Wide screen]**.

Change picture format

- 1 Press **⏏** **ADJUST**.
- 2 Select **[Picture format]**, then press **OK**.
- 3 Select a picture format, then press **OK**.

Summary of picture formats

The following picture settings can be configured.

Note

- Depending on the format of the picture source, some picture settings are not available.



[Auto format]: For selected models. (Not for PC mode.) Automatically display the suitable picture format. If not, widescreen is applied.



[Auto fill]: For selected models. Adjust the picture to fill the screen (subtitles remain visible). Recommended for minimal screen distortion but not for HD or PC.



[Auto zoom]: For selected models. Enlarge the picture to fill the screen. Recommended for minimal screen distortion but not for HD or PC.



[Super zoom]: (Not for HD and PC mode.) Remove the black bars on the side of 4:3 broadcasts. There is minimal distortion.



[4:3]: Show the classic 4:3 format.

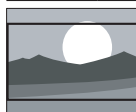

[Movie expand 16:9]: (Not for HD and PC mode.) Scale 4:3 format to 16:9.



[Wide screen]: Scale 4:3 format to 16:9.



[Unscaled]: For HD and PC mode only, and in selected models only. Allow maximum sharpness. Some distortion may be present due to the broadcaster's systems. Set your PC resolution to wide screen mode for best results.

Use smart sound

Use smart sound to apply pre-defined sound settings.

- 1 Press **⏏** **ADJUST**.
- 2 Select **[Smart sound]**, then press **OK**.
- 3 Select one of the following settings, then press **OK**.
 - **[Personal]:** Apply the settings that were customised in the sound menu.
 - **[Standard]:** Settings that suit most environments and types of audio.
 - **[News]:** Ideal settings for spoken audio, such as news.
 - **[Cinema]:** Ideal settings for movies.
 - **[Game]:** Ideal settings for games.
 - **[DRAMA]:** Ideal settings for drama programmes.
 - **[Sports]:** Ideal settings for sports programmes.

Manually adjust sound settings

- 1 Press **▲**.
- 2 Select **[Setup]** > **[TV settings]** > **[Sound]**, then press **OK**.
↳ The **[Sound]** menu appears.
- 3 Select one of the following settings, then press **OK**.
 - **[Smart sound]**: Access predefined smart sound settings.
 - **[Reset]**: Reset to factory default settings.
 - **[Clear sound]**: Enhance the sound clarity.
 - **[Bass]**: Adjust the bass level.
 - **[Treble]**: Adjust the treble level.
 - **[Surround]**: Switch on spatial sound.
 - **[Incredible Surround]**: (For selected models) Enhanced spatial sound for increased surround effect.
 - **[Headphone volume]**: (For models with headphones) Adjust headphone volume.
 - **[Auto volume levelling]**: Automatically reduce sudden volume changes, for example when switching channels.
 - **[Balance]**: Adjust the balance of the right and left speakers.
 - **[Digital output format]**: Select the type of digital audio output through digital audio output connector.
 - **[PCM]**: Convert non-PCM audio type to PCM format.
 - **[Multichannel]**: Output audio to the home theatre.

Use the universal access menu

You can activate the universal access menu during the first installation. Once enabled, you can quickly access the visually impaired and hearing impaired menus when watching TV or external devices.

- 1 While you watch TV, press **≡** **OPTIONS**.
↳ The TV options menu appears.
- 2 Select **[Universal access]**, then press **OK**.
- 3 Select one of the following options, then press **OK**.
 - **[Hearing impaired]**: Enable or disable hearing impaired subtitles.
 - **[Visually impaired]**: Some digital TV channels broadcast special audio adapted for people who are visually impaired. The normal audio is mixed with extra commentary. Use the colour buttons to select the options:
 - Red (**[Off]**): Turn off visually impaired audio.
 - Green (**[Speakers]**): Hear visually impaired audio from speakers only
 - Yellow (**[Headphone]**): Hear visually impaired audio from headphones only.
 - Blue (**[Speaker + headphone]**): Hear visually impaired audio from both speakers and headphone.
 - **[Mixed volume]**: Adjust the volume of visually impaired audio.
 - **[Key beep]**: Switch on audio feedback when buttons are pressed on the remote control or TV.

 **Tip**

- Press the colour buttons on the remote control to enter the options.

Use advanced teletext features

Access the teletext options menu

Access the teletext features through the teletext options menu.

- 1 Press **TEXT**.
↳ The teletext screen appears.
- 2 Press **≡** **OPTIONS**.
↳ The teletext options menu appears.
- 3 Select one of the following options, then press **OK**.
 - **[Freeze page] / [Unfreeze page]**: Freeze/unfreeze the current page.
 - **[Dual screen] / [Full screen]**: Switch between full screen and dual screen teletext.
 - **[T.O.P. overview]**: Switch on Table of Pages teletext broadcasts
 - **[Enlarge] / [Normal view]**: Switch between enlarged and normal view of teletext pages.
 - **[Reveal]**: Hide or reveal hidden information on a page, such as solutions to riddles or puzzles.
 - **[Cycle subpage]**: If subpages are available, automatically display each subpage in sequence.
 - **[Languages]**: Select a language for teletext.

Select teletext subpages

A teletext page can contain several subpages. Subpages are displayed next to the main page number:

- 1 Press **TEXT**.
↳ The teletext screen appears.
- 2 Press **◀** or **▶** to select a teletext page.
- 3 Press **◀** or **▶** to enter a subpage.

Select T.O.P. teletext broadcasts

Jump from one subject to another without entering page numbers with Table Of Pages (T.O.P.) teletext broadcasts. T.O.P. teletext broadcasts are available on selected TV channels.

- 1 Press **TEXT**.
↳ The teletext screen appears.
- 2 Press **≡** **OPTIONS**.
- 3 Select **[T.O.P. overview]**, then press **OK**.
↳ The T.O.P. overview appears.
- 4 Select a subject.
- 5 Press **OK** to view the page.

Use Teletext 2.5

Teletext 2.5 offers more colours and better graphics than normal teletext. If Teletext 2.5 is broadcast by a channel, it is switched on by default.

- 1 Press **▲**.
- 2 Select **[Setup] > [TV settings] > [Preferences] > [Teletext 2.5]**.
- 3 Select **[On]** or **[Off]**, then press **OK** to confirm.

Create and use lists of favourite channels

You can create a list of your preferred TV channels so that you can find those channels easily.

View only the list of favourite channels

- 1 While you watch TV, press **Q FIND**.
↳ The channel matrix menu is displayed.
- 2 Press **≡ OPTIONS**.
- 3 Select **[Select list] > [Favourites]**, then press **OK**.
↳ Only channels in the favourites list appear in the channel grid.

Note

- The favourites channel grid is empty until you add channels into the favourites list.

View all channels

You can exit the favourites list, and view all installed channels.

- 1 While you watch TV, press **Q FIND**.
↳ The channel matrix menu is displayed.
- 2 Press **≡ OPTIONS**.
- 3 Select **[Select list] > [All]**, then press **OK**.
↳ All channels are displayed in the channel grid.

Note

- All favourite channels are marked by an asterisk when you view the channel grid.

Manage the favourites list

- 1 While you watch TV, press **Q FIND**.
↳ The channel matrix menu appears.
- 2 Press **≡ OPTIONS**.
- 3 Select **[Select list] > [All]**, then press **OK**.
- 4 Press **≡ OPTIONS**.
- 5 Select **[Mark as favourite]** or **[Unmark as favourite]**, then press **OK**.
↳ The channel is added or removed from the favourite list.

Note

- All favourite channels are marked by an asterisk in the channel grid.

Use the Electronic Programme Guide

The programme guide is an on-screen guide available for digital channels. It allows you to:

- View a list of digital programmes being broadcast
- View upcoming programmes
- Group programmes by genre
- Set reminders when programmes start
- Setup preferred programme guide channels

Switch on EPG

- 1 Press **▲**.
- 2 Select **[Programme guide]**, then press **OK**.
↳ The programme guide appears displaying information about the scheduled programmes.

Note

- Programme guide data is available only in selected countries and can take some time to load.

Change programme guide options

You can set or clear reminders, change the day, and access other useful options in the programme guide options menu.

- 1 Press **▲**.
- 2 Select **[Programme guide]**, then press **OK**.
- 3 Press **☰** **OPTIONS**.
↳ The programme guide menu appears.
- 4 Select one of the following options, then press **OK**.
 - **[Set reminder] / [Clear reminders]**: Set or clear programme reminders.
 - **[Change day]**: Set the programme guide day.
 - **[More info]**: Display programme information.
 - **[Search by genre]**: Search TV programmes by genre.
 - **[Scheduled reminders]**: List programme reminders. Only available for upcoming programmes.
 - **[Acquire EPG data]**: Update the latest programme guide information.

Display the TV clock

You can display a clock on the TV screen. The clock displays the current time using time data received from your TV service operator.

Set the TV clock manually

In some countries, you need to set TV clock manually.

- 1 Press **▲**.
- 2 Select **[Setup] > [TV settings] > [Preferences] > [Clock]**.
- 3 Select **[Auto clock]**, then press **OK**.
- 4 Select **[Manual]**, then press **OK**.
- 5 Select **[Time]** or **[Date]**, then press **OK**.
- 6 Press the **Navigation buttons** to set the time or date.
- 7 Select **[Done]**, then press **OK**.
- 8 Press **▲** to exit.

Note

- If your selected country supports digital broadcast, the clock displays the time data from your TV service operator as priority.

Display the TV clock

- 1 While you watch TV, press **☰** **OPTIONS**.
↳ The options menu is displayed.
- 2 Select **[Clock]**.
↳ The clock is displayed.
- 3 Press **OK**.

Note

- To disable the clock, repeat the procedure.

Change the clock mode

- 1 Press **▲**.
- 2 Select **[Setup] > [TV settings] > [Preferences] > [Clock] > [Auto clock]**.
- 3 Select **[Automatic]** or **[Manual]**, then press **OK**.

Change the time zone

Note

- This option is only available if you select **[Auto clock] > [Automatic]** (in countries with clock transmission data).

- 1 Press **▲**.
- 2 Select **[Setup] > [TV settings] > [Preferences] > [Clock] > [Time zone]**.
- 3 Select your time zone.
- 4 Press **OK** to confirm.

Use daylight saving

Note

- This option is only available if you select **[Auto clock mode] > [Manual]**.

- 1 Press **▲**.
- 2 Select **[Setup] > [TV settings] > [Preferences] > [Clock] > [Daylight saving]**, then press **OK**.
- 3 Select **[Standard time]** or **[Daylight saving time]**, then press **OK**.

Use timers

You can set timers to switch the TV to standby at a specified time.

Tip

- Set the TV clock before you use timers.

Automatically switch the TV to standby (sleep timer)

Sleep timer switches the TV to standby after a pre-defined duration.

Tip

- You can switch off your TV earlier or reset the sleep timer during the countdown.

- 1 Press **▲**.
- 2 Select **[Setup] > [TV settings] > [Preferences] > [Sleep timer]**.
↳ The **[Sleep timer]** menu appears.
- 3 Select a value between zero and 180 minutes.
↳ If you select zero, the sleep timer switches off.
- 4 Press **OK** to switch on the sleep timer.
↳ The TV switches to standby after the specified time.

Lock unsuitable content

You can prevent your children from watching certain programmes or channels by locking the TV controls.

Set or change code

- 1 Press **▲**.
- 2 Select **[Setup] > [Channel settings] > [Child lock]**.
- 3 Select **[Set code]** or **[Change code]**.
↳ The **[Set code] / [Change code]** menu appears.
- 4 Enter your code using the **Numeric buttons**.
↳ Follow the on-screen instructions to create or change your PIN code.



Tip

- If you forget your code, enter '8888' to override any existing codes.

Lock or unlock one or more channels

- 1 Press **▲** > **[Setup] > [Channel settings] > [Child lock] > [Channel lock]**.
↳ A list of channels is displayed.
- 2 Select the channel that you want to lock or unlock, then press **OK**.
↳ The first time you lock or unlock a channel, you are prompted to enter your PIN code.
- 3 Enter your code and press **OK**.
↳ If the channel is locked, a lock icon is displayed.
- 4 Repeat the process to lock or unlock more channels.
- 5 To activate the locks, switch the TV on and off.
↳ When you switch channels with **CH -** or **CH +**, the locked channels are skipped.
↳ When you access the locked channels from the channel grid, you are prompted to enter your PIN code.

Set parental ratings

Some digital broadcasters rate their programmes according to age. You can set your TV to display only programmes with age ratings lower than your child's age.

- 1 Press **▲**.
- 2 Select **[Setup] > [Channel settings] > [Child lock] > [Parental rating]**.
↳ A code setup screen appears.
- 3 Enter your code using **Numeric buttons**.
↳ The rating menu appears.
- 4 Select an age rating, then press **OK**.
- 5 Press **▲** to exit.

View Scenea

You can display a default picture as the wallpaper on your TV. You can also load another picture as the wallpaper.

If the sleeptimer is off, the wallpaper is displayed for 240 minutes. Otherwise, it is displayed for the duration of the sleeptimer.

Switch on Scenea

- 1 Press **▲**.
- 2 Select **[Scenea]**, then press **OK**.
 - ↳ If no picture has been set, the default picture is displayed.
 - ↳ If a customised Scenea picture is loaded, that picture is displayed (see 'Customise the Scenea picture' on page 24).

Customise the Scenea picture

You can load another picture as the wallpaper.



Note

- When you load a new Scenea picture, it overrides the current Scenea picture.
- To use another picture as the wallpaper, you need a USB storage device that contains a picture that is less than 1 MB in size.

- 1 Load a picture smaller than 1MB in size into a USB storage device.
- 2 Connect the USB storage device to the TV.
- 3 Press **▲**.
- 4 Select **[Browse USB]**, then press **OK**.
- 5 Select a picture, then press **≡ OPTIONS**.
- 6 Select **[Set as Scenea]**, then press **OK**.
- 7 Press any button to exit Scenea.

Change language

Depending on your broadcaster, you can change the audio language, subtitle language, or both, for a TV channel.

Multiple audio languages, subtitles, or both, are broadcast through teletext or DVB-T digital broadcasts. Dual sound broadcasts: With digital broadcasts, you can select a subtitle language.

Change menu language

- 1 Press **▲**.
- 2 Select **[Setup] > [TV settings] > [Preferences] > [Menu language]**, then press **OK**.
- 3 Select a language, then press **OK**.

Change audio language

You can choose an audio language if it is available from your broadcaster. For digital channels, multiple languages may be available. For analogue channels, two languages may be available.

- 1 While you watch TV, press **≡ OPTIONS**.
- 2 For digital channels, select **[Audio language]**, select the language, then press **OK**.
- 3 For analogue channels, select **[Dual I-II]**, select either language, then press **OK**.

Show or hide subtitles

- 1 While you watch TV, press **SUBTITLE**.
- 2 Select one of the following, then press **OK**.
 - **[Subtitles on]**: Always display subtitles.
 - **[Subtitles off]**: Never display subtitles.
 - **[On during mute]**: When audio is muted, display subtitles.



Note

- Repeat this procedure to enable subtitles on each analogue channel.
- Select **[Subtitles] > [Subtitles off]** to disable subtitles.

Select a subtitle language in digital channels

Note

- When you select a subtitle language in a digital TV channel as described below, the preferred subtitle language set in the installation menu is temporarily overruled.

- While you watch TV, press **≡** **OPTIONS**.
- Select **[Subtitle language]**, then press **OK**.
- Select a subtitle language.
- Press **OK** to confirm.

Play photos, music and videos on USB storage devices

Caution

- TPVision is not responsible if the USB storage device is not supported, nor is it responsible for damage or loss of data from the device.

Connect a USB storage device to play photos, music or videos stored on it.

- Switch on the TV.
- Connect the USB device to the USB port on the side of your TV.
- Press **⬆**.
- Select **[Browse USB]**, then press **OK**.
↳ The USB browser appears.

View photos

- In the USB browser, select **[Picture]**, then press **OK**.
- Select a photo or a photo album, then press **OK** to view the photo enlarged to fill the TV screen.
 - To view the next or previous photo, press **◀▶**.
- To return, press **↩**.

View a slide show of your photos

- When a full screen image of a photo is displayed, press **OK**.
↳ A slide show begins from the selected photo.
 - Press the following buttons to control play:
 - ▶** to play.
 - ⏸** to pause.
 - ◀** or **▶** to play the previous or next photo.
 - to stop.
 - To return, press **↩**.

Change slide show settings

- While you view a slide show, press **≡** **OPTIONS**.
↳ The slide show options menu is displayed.
- Select one of the following, then press **OK**.
 - [Start/Stop slideshow]**: Start or stop slideshow.
 - [Slideshow transitions]**: Set the transition from one picture to the next.
 - [Slideshow frequency]**: Select the display time for each photo.
 - [Repeat] / [Play once]**: View the pictures in the folder once only, or repeatedly.
 - [Shuffle off] / [Shuffle on]**: View the pictures in sequential order, or at random.
 - [Rotate image]**: Rotate photo.
 - [Show info]**: Display the picture name, date, size and next picture in the slide show.
 - [Set as Scenea]**: Set the selected picture as the TV wallpaper (see 'View Scenea' on page 24).
- To return, press **↩**.

Note

- [Rotate image]** and **[Show info]** appear only when the slideshow is paused.

Listen to music

- 1 In the USB browser, select **[Music]**, then press **OK**.
- 2 Select a music track or album, then press **OK** to play.
- 3 To control play, press the play buttons:
 - **▶** to play.
 - **⏸** to pause.
 - **◀** or **▶** to play the previous or next track.
 - **◀◀** or **▶▶** to search forward or backward.
 - **■** to stop.

Change music settings

- While you play music, press **≡ OPTIONS** to access one of the following settings, then press **OK**.
 - **[Stop playback]**: Stop music play.
 - **[Repeat]**: Play a song once or repeatedly.
 - **[Shuffle on]** / **[Shuffle off]**: Play songs in sequence or at random.
 - **[Show info]**: Display the file name.

Watch video

- 1 In the USB browser, select **[Video]**, then press **OK**.
- 2 Press **OK** to play.
- 3 To control play, press the play buttons:
 - **▶** to play.
 - **⏸** to pause.
 - **◀** or **▶** to play the previous or next video.
 - **◀◀** or **▶▶** to search forward or backward.
 - **■** to stop.

Change video settings

- While you play video, press **≡ OPTIONS** to access one of the following settings, then press **OK**.
 - **[Stop playback]**: Stop video play.
 - **[Repeat]**: Play once or repeatedly.
 - **[Full screen]** / **[Small Screen]**: View the video stretched to fill the screen, or view it in its native picture format.
 - **[Shuffle on]** / **[Shuffle off]**: Play in sequence or at random.
 - **[Show info]**: Display the file name.

View a slideshow with music

You can view a picture slide show with background music.

- 1 Select an album of songs.
- 2 Press **OK**.
- 3 Press **↶** to return to the USB content browser.
- 4 Select an album of pictures.
- 5 Press **OK**.
↳ The slideshow begins.
- 6 To exit, press **↶**.

Disconnect a USB storage device

Caution

- Follow this procedure to avoid damage to your USB storage device.

- 1 Press **↶** to exit the USB browser.
- 2 Wait for five seconds, then disconnect the USB storage device.

Listen to digital radio channels

- 1 Press **Q** **FIND**.
↳ The channel matrix menu is displayed.
- 2 Press **☰** **OPTIONS**, then select **[Select list]** > **[Radio]**.
↳ The radio channel grid appears.
- 3 Select a radio channel and press **OK** to listen.

Update the TV software

Philips continuously tries to improve its products and we recommend that you update the TV software when updates are available.

Ways to update the TV software

You can update the TV software in one of the following ways:

- A: with a USB storage device,
 B: when prompted through digital broadcasts, or
 C: after being prompted through digital broadcasts.

A: Update with a USB device

To update with a USB storage device, you need:

- An empty USB flash drive. The USB flash drive must be FAT or DOS-formatted. Do not use a USB hard drive.
- A computer with Internet access
- An archive utility that supports the ZIP file format (for example, WinZip® for Microsoft® Windows® or StuffIt® for Macintosh®).

Step 1: Check the current software version

- 1 Press **▲**.
- 2 Select **[Setup]** > **[Software settings]** > **[Current software inf.]**.
↳ The current software information is displayed.
- 3 Write down the software version number.
- 4 To return, press **OK**.
- 5 To exit, press **↶**.

Step 2: Download and update the latest software version

- 1 Connect a USB storage device.
- 2 Press **▲**.
- 3 Select **[Setup]** > **[Update software]**.
- 4 Follow the instructions to load a file onto your USB storage device.
- 5 Connect the USB storage device to your computer; then double-click the file.
↳ A Web page is launched.
- 6 Follow the instructions in the Web page.
 - If the current software version matches the latest software update file, you do not need to update your TV software.
 - If the current software version is smaller than the latest software update file, download the latest software update file to the root directory of your USB device.
- 7 Disconnect the USB storage device from the computer.

Step 3: Update the TV software

- 1 Connect your USB storage device to the TV.
↳ The TV detects the USB flash drive and starts to scan for software version.
- 2 If a message prompts you to update the software, follow the on-screen instructions to update the TV software.
- 3 If the message is not displayed, continue with the following steps:
- 4 Press **▲**.
- 5 Select **[Setup] > [Software settings] > [Local updates]**.
- 6 Select the file that you downloaded, then press **OK** to update the TV software manually.
- 7 Follow the on-screen instructions to complete the update.
- 8 To exit, press **↶**.

B: Update when prompted through digital broadcasts

If you receive digital broadcasts (DVB-T), your TV can automatically receive software updates. When your TV receives a software update, it will prompt you to update the TV software.

- 1 Press **▲**.
- 2 Select **[Setup] > [Software settings] > [Announcement]**.
- 3 If a message appears to prompt you to update your software, follow the instructions to start the update.
↳ The TV restarts after the software update is complete.
- 4 If you do not want to update the software, select **[Setup] > [Software settings] > [Clear announcement]**, then press **OK**.

Note

- If you skip the update, you can update it manually later (see 'C: Check for updates through digital broadcasts' on page 28).

C: Check for updates through digital broadcasts

You can check if there are updates available through digital broadcasts.

- 1 Press **▲**.
- 2 Select **[Setup] > [Software settings] > [Check on major updates]**.
- 3 If an update is available, follow the on-screen instructions to start the update.
↳ The TV restarts after the software update is complete.

Change TV preferences

Use the preferences menu to customise your TV settings.

- 1 Press **▲**.
- 2 Select **[Setup] > [TV settings] > [Preferences]**.
- 3 Select one of the following, then press **OK**.
 - **[Menu language]**: Select a menu language.
 - **[Sleep timer]**: Switch the TV to standby after a pre-defined duration.
 - **[Location]**: Optimise TV settings for your location - home or shop.
 - **[E-sticker]**: (For shop mode only) Switch the e-sticker on or off.
 - **[Volume bar]**: Display the volume bar when you change the volume.
 - **[Auto switch off]**: To conserve energy, set the TV to switch to standby automatically after a period of inactivity.
This TV is also designed with other energy efficiency settings. If there is no user interaction (such as pressing a remote control button or a control on the front panel) for four hours, the TV will automatically switch to standby.
 - **[Channel information size]**: Change the type of information that is displayed when you switch channels.
 - **[Universal access]**: Enable or disable the universal access menu.
 - **[Key beep]**: Enable audio feedback when you press buttons on the remote control or TV.
 - **[Audio out delay]**: Automatically sync the image on your TV to the audio from a connected home theatre.
 - **[TV position]**: Apply the best settings for your TV based on how it is mounted.
 - **[Teletext 2.5]**: Enable or disable Teletext 2.5. (For digital TV)
 - **[Clock]**: Display or remove the time from the TV, and set clock options.

Start a TV demo

You can use demonstrations to better understand the features of your TV. Some demos are not available on certain models. Available demos are displayed in the menu list.

- 1 While you watch TV, press **▲**.
- 2 Select **[Setup] > [Watch demo]**, **OK**.
- 3 Select a demo and press **OK** to view it.
- 4 To exit, press **↶**.

Reset the TV to factory settings

You can restore the default picture and sound settings of your TV. The channel installation settings remain the same.

- 1 Press **▲**.
- 2 Select **[Setup] > [TV settings] > [Factory settings]**, then press **OK**.
- 3 If you are prompted to enter a code, enter the child-lock code (see 'Set or change code' on page 23).
↳ A confirmation message is displayed.
- 4 Press **OK** to confirm.

6 Install channels

The first time you set up your TV, you are prompted to select a menu language and to install TV and digital radio channels (if available). Afterwards, you can re-install and fine tune channels.

Automatically install channels

You can search and store channels automatically.

Step 1: Select your menu language

- 1 Press **▲**.
- 2 Select **[Setup]** > **[TV settings]** > **[Preferences]** > **[Menu language]**, then press **OK**.
- 3 Select a language, then press **OK**.

Step 2: Search for channels

When the TV was switched on for the first time, a full installation of channels was performed. You can run this full installation again to set your language, country, and install all available TV channels.

 **Note**

- For selected models, some options are different.

- 1 Press **▲**.
- 2 Select **[Setup]** > **[Search for channels]**, then press **OK**.
- 3 Select **[Reinstall channels]**, then press **OK**.
↳ The country menu is displayed.
- 4 Select your country, then press **OK**.
↳ The network menu is displayed.

- 5 Select the network, then press **OK**.
 - **[Antenna]**: For free-to-air antenna or digital DVB-T channels.
 - **[Cable]**: For cable or digital DVB-C channels.
- 6 Follow the onscreen instructions to select other options, if any.
↳ The start menu for channel search is displayed.
- 7 Select **[Start]**, then press **OK**.
↳ All available channels are stored.
- 8 To exit, press **OK**.

Update the channel list

You can enable automatic update of channels when your TV is in standby mode. The channels stored in your TV are updated every morning according to the channel information in the broadcast.

- 1 Press **▲**.
- 2 Select **[Setup]** > **[Channel settings]** > **[Channel installation]** > **[Automatic channel update]**.
- 3 Select **[On]** to enable the automatic update or select **[Off]** to disable it.
- 4 To return, press **↶**.

Manually install analogue channels

You can search and store analogue TV channels one at a time.

Step 1: Select your system

Note

- If your system settings are correct, skip this step.

- 1 Press **▲**.
- 2 Select **[Setup]** > **[Channel settings]** > **[Channel installation]** > **[Analogue: Manual antenna installation]** > **[System]**, then press **OK**.
- 3 Select the correct system for your country or region, then press **OK**.

Step 2: Search and store channels

- 1 Press **▲**.
- 2 Select **[Setup]** > **[Channel settings]** > **[Channel installation]** > **[Analogue: Manual antenna installation]** > **[Find channel]**, then press **OK**.
 - If you know the three-digit frequency of the channel, enter it.
 - To search, select **[Search]**, then press **OK**.
- 3 When the channel is found, select **[Done]**, then press **OK**.
 - To store the channel as a new number, select **[Store as new channel]**, then press **OK**.
 - To store the channel as the previously selected channel, select **[Store current channel]**, then press **OK**.

Step 3: Fine-tune channels

- 1 Press **▲**.
- 2 Select **[Setup]** > **[Channel settings]** > **[Analogue: Manual antenna installation]** > **[Fine-tune]**, then press **OK**.
- 3 Press **▲▼** to fine-tune the channel.

Manually install digital channels

You can search and store digital TV channels one at a time.

- 1 Press **▲**.
- 2 Select **[Setup]** > **[Channel settings]** > **[Channel installation]** > **[Digital: Reception test]** > **[Find channel]**, then press **OK**.
- 3 Press the **Numeric buttons** to enter the channel frequency.
- 4 Select **[Search]**, then press **OK**.
- 5 When the correct channel is located, select **[Store]**, then press **OK**.
- 6 To exit, press **↶**.

Note

- If the reception is poor, reposition your antenna and repeat the procedure.
- If you receive the channel with DVB-C, select **[Symbol rate mode]** > **[Automatic]**, unless your cable provider supplies you with a specific symbol rate value.

Rename channels

You can rename channels. The name appears when you select the channel.

- 1 While you watch TV, press **Q FIND**.
↳ The channel matrix menu is displayed.
- 2 Select the channel to rename.
- 3 Press **≡ OPTIONS**.
↳ The channel options menu appears.
- 4 Select **[Rename channel]**, then press **OK**.
↳ A text input box appears.
- 5 Press **▲▼◀▶** to select each character, then press **OK**.
- 6 When the name is complete, select **[Done]**, then press **OK**.

Tip

- Press **[Aa]** to change an uppercase letter to a lowercase letter and vice versa.

Rearrange channels

After you install channels, you can rearrange the order in which they appear:

- 1 While you watch TV, press **Q FIND**.
↳ The channel matrix menu is displayed.
- 2 Press **☰ OPTIONS**.
↳ The channel options menu appears.
- 3 Select **[Reorder]**, then press **OK**.
- 4 Select the channel to rearrange, then press **OK**.
↳ The selected channel is highlighted.
- 5 Move the highlighted channel to its new location, then press **OK**.
- 6 Press **☰ OPTIONS**.
- 7 Select **[Done reordering]**, then press **OK**.

Access CAM services

- 1 Insert and activate the CAM (see 'Insert and activate a CAM' on page 37).
- 2 Press **☰ OPTIONS**.
- 3 Select **[Common interface]**.
↳ Applications provided by the digital TV service operator are displayed.

Note

- This menu option is available only if the CAM is inserted and activated correctly.

7 Connect devices

This section describes how to connect devices with different connectors. For the location of these connectors on your TV, see the quick start guide. More examples of connections with other devices are provided in the Quick Start Guide.

Note

- You can use different types of connectors to connect a device to your TV.

Tip

- After connection, for easy access to your device, add it to the home menu: press **Home**, then select **[Add new device]**.

Back connections

1 TV ANTENNA

Signal input from an antenna, cable or satellite.

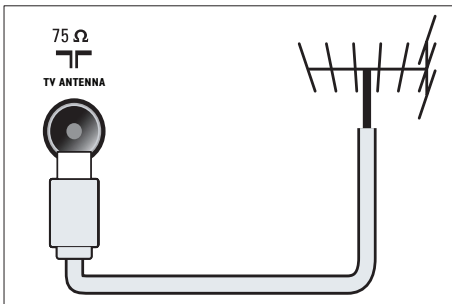

2 EXT 1 (RGB and CVBS)

Analogue audio and video input from analogue or digital devices such as DVD players or game consoles.

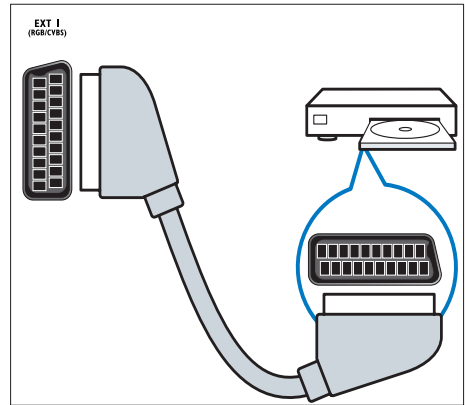

3 DIGITAL AUDIO OUT

Digital audio output to home theatres and other digital audio systems.

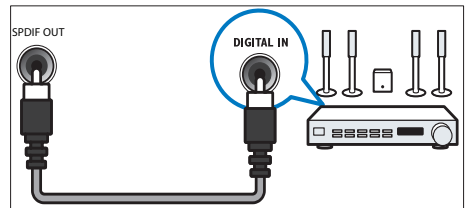

4 SERV. U

For use by service personnel only.

⑤ PC IN (VGA and AUDIO IN)

Audio and video input from a computer.

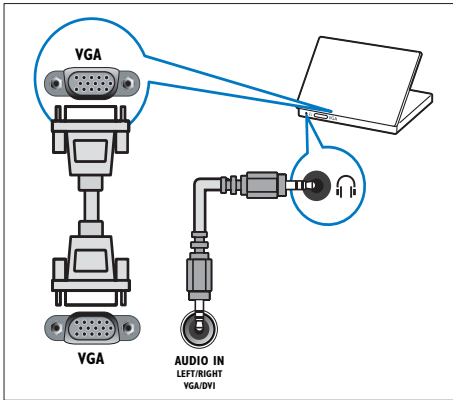

⑥ HDMI 1 ARC

Digital audio and video input from high-definition digital devices such as Blu-ray players. Also outputs TV audio to other EasyLink-compliant devices, such as home theatre systems.

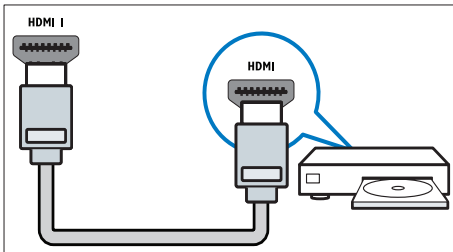

Connections via DVI or VGA require an additional audio cable (see 'Connect a computer' on page 36).

⑦ HDMI 2 (For selected models)

Digital audio and video input from high-definition digital devices such as Blu-ray players.

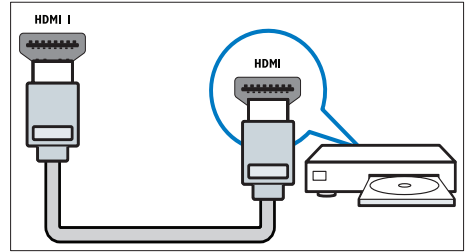

Connections via DVI or VGA require an additional audio cable (see 'Connect a computer' on page 36).

⑧ EXT 2 (Y Pb Pr and AUDIO L/R)

Analogue audio and video input from analogue or digital devices such as DVD players or game consoles.

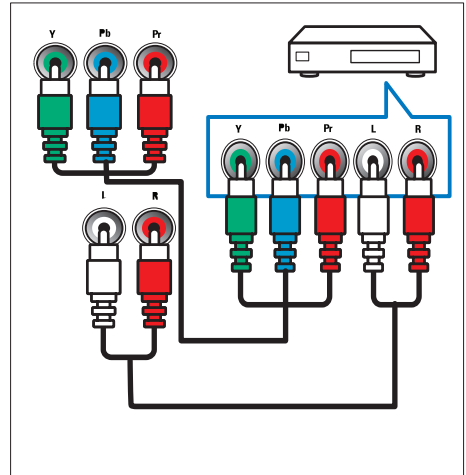

Side connections

① AUDIO L/R

Audio input from analogue devices connected to **VIDEO**.

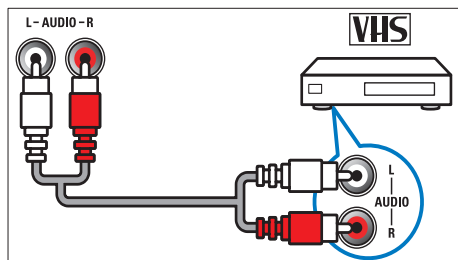

② VIDEO

Composite video input from analogue devices such as VCRs.

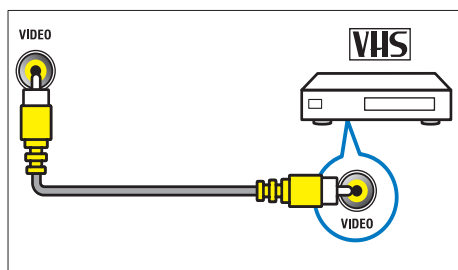

③ USB

Data input from USB storage devices.

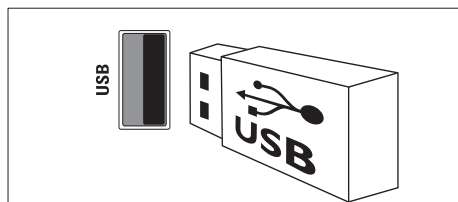

④ HDMI

Digital audio and video input from high-definition digital devices such as Blu-ray players.

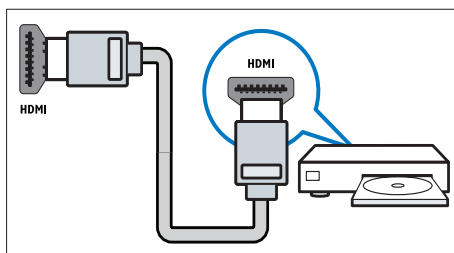

⑤ (Headphone)

Stereo audio output to headphones or earphones.

⑥ COMMON INTERFACE

Slot for a Conditional Access Module (CAM).

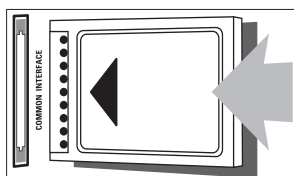

Connect a computer

Before you connect a computer to the TV

- Set the screen refresh rate on your computer to 60Hz.
- Select a supported screen resolution on your computer.

Connect a computer with one of the following connectors:

Note

- Connections via DVI or VGA require an additional audio cable.

- HDMI cable

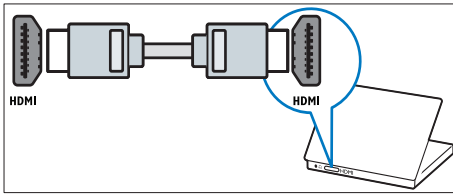

- DVI-HDMI cable

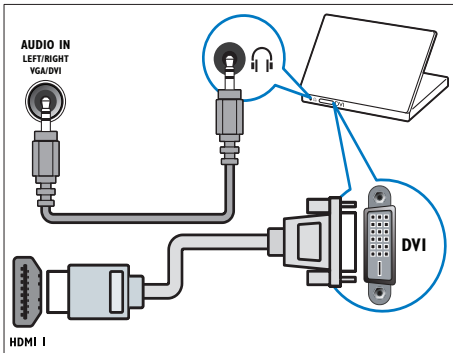

- HDMI cable and HDMI-DVI adaptor

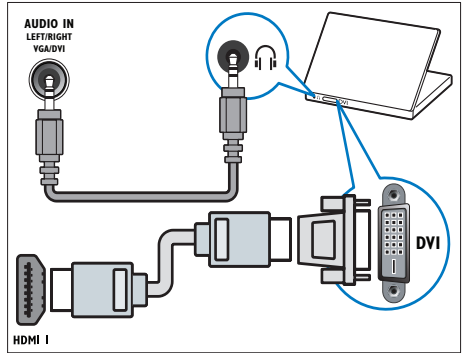

- VGA cable

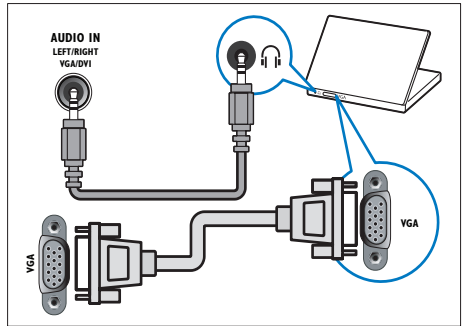

Use a Conditional Access Module

A Conditional Access Module (CAM) is provided by digital TV service operators to decode digital TV channels.

Note

- Refer to the documentation from your service operator on how to insert a smart card into the Conditional Access Module.

Access CAM services

- 1 Insert and activate the CAM (see 'Insert and activate a CAM' on page 37).
- 2 Press **≡** **OPTIONS**.
- 3 Select **[Common interface]**.
 - ↳ Applications provided by the digital TV service operator are displayed.

Note

- This menu option is available only if the CAM is inserted and activated correctly.

Insert and activate a CAM

Caution

- Be sure to follow the instructions described below. Wrong insertion of a CAM may damage both the CAM and your TV.

- 1 Switch off the TV and disconnect it from the power outlet.
- 2 Following the directions printed on the CAM, gently insert the CAM into the **COMMON INTERFACE** at the side of the TV.

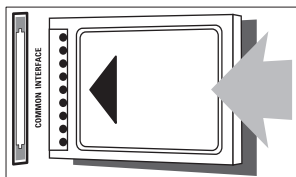

- 3 Push the CAM in as far as it will go.
- 4 Reconnect the TV to the power outlet.
- 5 Turn on the TV and wait for the CAM to be activated. This may take several minutes. Do not remove the CAM from the slot when in use — this action deactivates digital services.

Use Philips EasyLink

Get the most out of your HDMI-Consumer Electronic Control (CEC) compliant devices with Philips EasyLink enhanced control features. If your HDMI-CEC compliant devices are connected through HDMI, you can control them at the same time with your TV remote control.

To enable Philips EasyLink, you need to:

- Connect at least two HDMI-CEC compliant devices through HDMI
- Configure each HDMI-CEC compliant device properly
- Switch on EasyLink

Note

- The EasyLink-compliant device must be switched on and selected as the source.
- Philips does not guarantee 100% interoperability with all HDMI CEC devices.

Switch on or off EasyLink

When you play an HDMI-CEC compliant device, the TV switches on from standby, and switches to the correct source.

Note

- If you do not intend to use Philips EasyLink, switch it off.

- 1 Press **▲**.
- 2 Select **[Setup] > [TV settings] > [EasyLink] > [EasyLink]**.
- 3 Select **[On]** or **[Off]**, then press **OK**.

Use one-touch play

- 1 After you switch on EasyLink, press play on your device.
 - ↳ The TV automatically switches to the correct source.

Use one-touch play control

If you connect multiple HDMI-CEC devices that support this setting, all such devices respond to the play control buttons on this TV remote control.

! Caution

- This is an advanced setting. Devices that do not support this setting will not respond to the TV remote control.

- 1 Press **▲**.
- 2 Select **[Setup] > [TV settings] > [EasyLink] > [EasyLink remote control]**.
- 3 Select **[On]** or **[Off]**, then press **OK**.

Use one-touch standby

When you press **⏻** on the TV remote control, the TV and all HDMI-CEC compliant devices switch to standby mode.

- 1 Press **⏻** (**Standby-On**) on the TV's or device's remote control.
 - ↳ The TV and all connected HDMI devices switch to standby.

Set TV speakers to EasyLink mode

If you connect an HDMI-CEC compliant device that includes speakers, you can choose to hear the TV from those speakers instead of the TV speakers.

When you play content from an EasyLink compliant home theatre, if you want to mute the TV speakers automatically, turn on EasyLink mode.

If the connected device is HDMI Audio Return Channel (ARC) compliant, and you connect the device through an HDMI ARC connector, you can output TV audio through the HDMI cable. You do not need an additional audio cable.

- 1 Make sure that the EasyLink-compliant device is connected through an HDMI ARC connector (see 'Back connections' on page 33).
- 2 Select **[Setup]** > **[TV settings]** > **[EasyLink]** > **[TV speakers]**.
- 3 Select one of the following, then press **OK**.
 - **[Off]**: Switch off TV speakers.
 - **[On]**: Switch on TV speakers.
 - **[EasyLink]**: Stream TV audio through the connected HDMI-CEC device. Switch the TV audio to the connected HDMI-CEC audio device through the adjust menu.
 - **[EasyLink autostart]**: Turn off TV speakers automatically and streams TV audio to the connected HDMI-CEC audio device.



Note

- To mute the TV speakers, select **[TV speakers]** > **[Off]**.

Select speaker output with Adjust menu

If **[EasyLink]** or **[EasyLink autostart]** are selected, access the adjust menu to switch the TV audio.

- 1 While you watch TV, press **⏸ ADJUST**.
- 2 Select **[Speaker]**, then press **OK**.
- 3 Select one of the following, then press **OK**:
 - **[TV]**: On by default. Stream TV audio through TV and the connected HDMI-CEC audio device until the connected device switches to system audio control. TV audio is then streamed through the connected device.
 - **[Amplifier]**: Stream audio through the connected HDMI-CEC device. If system audio mode is not enabled on the device, audio continue to stream from the TV speakers. If **[EasyLink autostart]** was enabled, the TV prompts the connected device to switch to system audio mode.

Maximise display for subtitled video

Some subtitles can create a separate subtitle bar under the video, which limits the video display area. After you switch on auto subtitle shift, the subtitles display over the video image, which maximises the video display area.

- 1 Press **⬆**.
- 2 Select **[Setup]** > **[TV settings]** > **[EasyLink]** > **[Auto subtitle shift]** > **[On]**, then press **OK**.

Retain picture quality

If your TV picture quality is affected by the picture-processing features of other devices, switch on Pixel Plus Link.

- 1 Press **⬆**.
- 2 Select **[Setup]** > **[TV settings]** > **[EasyLink]** > **[Pixel Plus Link]** > **[On]**, then press **OK**.

Hear TV audio through another device

If you connect an EasyLink- compliant device that has speakers, you can get the most out of those speakers if you listen to TV audio through them.

If the connected device is HDMI-ARC compliant, and you connect the device through an HDMI ARC connector, you can output TV audio through the HDMI cable. You will not need an additional audio cable.

- 1 Make sure that the EasyLink-compliant device is connected through an HDMI ARC connector (see 'Back connections' on page 33).
- 2 Press **▲**.
- 3 Select **[Setup] > [TV settings] > [EasyLink] > [HDMI1 - audio out]**, then press **OK**.
- 4 Select one of the following, then press **OK**.
 - **[On]**: Hear the TV audio through the connected EasyLink device. You cannot hear the TV audio through the TV speakers or through devices connected through the digital audio out connector.
 - **[Off]**: Hear the TV audio through the TV speakers, or through a device connected through the digital audio out connector.
- 5 Control playback with the TV remote control play buttons.

Switch all EasyLink devices to standby

To save electricity, you can switch all unused EasyLink-compliant devices to standby.

- 1 Press the **green** button.
- 2 Select **[Switch off unused sources]**, then press **OK**.
 - ↳ All connected EasyLink devices are switched to standby.

Use a Kensington lock

There is a Kensington security slot at the back of the TV. Prevent theft by looping a Kensington lock between the slot and a permanent object, such as a heavy table.

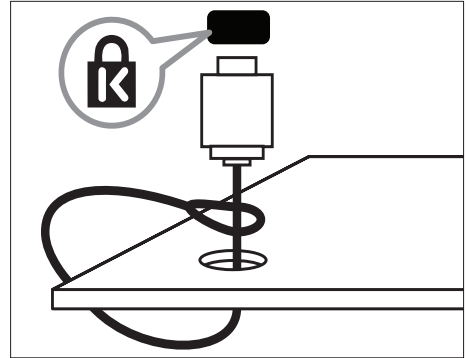

8 Product information

Product information is subject to change without notice. For detailed product information, go to www.philips.com/support.

Supported display resolutions

Computer formats

- Resolution - refresh rate:
 - 640 × 480 - 60 Hz
 - 800 × 600 - 60 Hz
 - 1024 × 768 - 60 Hz
 - 1280 × 720 - 60 Hz
 - 1280 × 768 - 60 Hz
 - 1280 × 1024 - 60 Hz
 - 1360 × 768 - 60 Hz
 - 1680 × 1050 - 60Hz (For Full HD only)
 - 1920 × 1080 - 60 Hz (For Full HD only)

Video formats

- Resolution - refresh rate:
 - 480i - 60 Hz
 - 480p - 60 Hz
 - 576i - 50 Hz
 - 576p - 50 Hz
 - 720p - 50 Hz, 60 Hz
 - 1080i - 50 Hz, 60 Hz
 - 1080p - 24 Hz, 25 Hz, 30 Hz, 50 Hz, 60 Hz.

Multimedia

- Supported storage device: USB (Only FAT or FAT 32 USB storage devices are supported)
- Supported multimedia file formats:
 - Images: JPEG
 - Audio: MP3
 - Video: MPEG 2/MPEG 4, H.264

Tuner / Reception / Transmission

- Antenna input: 75ohm coaxial (IEC75)
- DVB: DVB Terrestrial, DVB-C*, DVB-T, MPEG4
- TV system: DVB COFDM 2K/8K; PAL I, B/G, D/K; SECAM B/G, D/K, L/L'
- Video playback: NTSC, SECAM, PAL
- Tuner Bands: Hyperband, S-channel, UHF, VHF

*For selected models

Remote control

- Type: PF01E11B
- Batteries: 2 × AAA (LR03 type)

Power

- Mains power: 220-240V, 50Hz-60Hz
- Standby power:
 - For xxPFL5xx6: < 0.15 W
 - For xxPFL4xx6, xxPFL3xx6, and DesignLine Tilt: < 0.3 W
- Ambient temperature: 5 to 40 degrees Celsius
- For power consumption, see the product specifications at www.philips.com/support.

The power rating stated on the product typeplate is the power consumption for this product during normal household use (IEC 62087 Ed.2). The maximum power rating, stated between brackets, is used for electrical safety (IEC 60065 Ed. 7.2).

Supported TV mounts

To mount the TV, purchase a Philips TV mount or a compatible TV mount.



Warning

- Follow all instructions provided with the TV mount. TP Vision Netherlands B.V. bears no responsibility for improper TV mounting that results in accident, injury or damage.

Before you mount, perform these steps:

- To prevent damage to cables and connectors, leave a clearance of at least 2.2 inches or 5.5cm from the back of the TV.
- For selected models, remove the wall mount plugs from the back of the TV.
- Make sure that your mounting bolts follow these specifications:

TV screen size (inches)	Required pitch (mm)	Required mounting bolts
47	400 × 300	4 × M8 (10 mm)
46	400 × 400	4 × M6 (11/12 mm)
42	300 × 200	4 × M6 (10 mm)
40	400 × 400	4 × M6 (11/12 mm)
37	300 × 200	4 × M6 (10 mm)
32	200 × 200	4 × M6 (10 mm)
26	100 × 100	4 × M4 (10 mm)
22	100 × 100	4 × M4 (10 mm)

Product specification

Design and specifications are subject to change without notice.

47PFL4606H

- Without TV stand
 - Dimension (WxHxD): 1129.8 × 697.8 × 83 (mm)
 - Weight: 17.5 kg
- With TV stand
 - Dimension (WxHxD): 1129.8 × 745.6 × 268 (mm)
 - Weight: 20.9 kg

46PFL5606H

- Without TV stand
 - Dimension (WxHxD): 1080.8 × 652.9 × 39.9 (mm)
 - Weight: 16.9 kg
- With TV stand
 - Dimension (WxHxD): 1080.8 × 705.2 × 294.9 (mm)
 - Weight: 20.52 kg

42PFL4606H

- Without TV stand
 - Dimension (WxHxD): 1018.5 × 635.1 × 83 (mm)
 - Weight: 11.7 kg
- With TV stand
 - Dimension (WxHxD): 1018.5 × 683 × 236.4 (mm)
 - Weight: 14.2 kg

42PFL3606H/42PFL3506H

- Without TV stand
 - Dimension (WxHxD): 1018.5 × 635.8 × 83 (mm)
 - Weight: 11.7 kg
- With TV stand
 - Dimension (WxHxD): 1018.5 × 683 × 236.4 (mm)
 - Weight: 14.2 kg

40PFL5xx6H

- Without TV stand
 - Dimension (WxHxD): 946 × 577.5 × 40 (mm)
 - Weight: 12.3 kg
- With TV stand
 - Dimension (WxHxD): 946 × 631 × 243.6 (mm)
 - Weight: 15 kg

37PFL4606H

- Without TV stand
 - Dimension (WxHxD): 912.3 × 577.1 × 84.1 (mm)
 - Weight: 10.3 kg
- With TV stand
 - Dimension (WxHxD): 912.3 × 625.2 × 236.4 (mm)
 - Weight: 12.8 kg

32PFL5x06H

- Without TV stand
 - Dimension (WxHxD): 761 × 473 × 39.9 (mm)
 - Weight: 7.2 kg
- With TV stand
 - Dimension (WxHxD): 761 × 525.5 × 221 (mm)
 - Weight: 8.9 kg

32PFL4606H

- Without TV stand
 - Dimension (WxHxD): 795.6 × 510.6 × 93.1 (mm)
 - Weight: 8.2 kg
- With TV stand
 - Dimension (WxHxD): 795.6 × 557.6 × 221.4 (mm)
 - Weight: 9.8 kg

32PFL3606H/32PFL3506H

- Without TV stand
 - Dimension (WxHxD): 795.6 × 508.4 × 93.1 (mm)
 - Weight: 8.2 kg
- With TV stand
 - Dimension (WxHxD): 795.6 × 557.6 × 221.4 (mm)
 - Weight: 9.8 kg

32PFL3406H

- Without TV stand
 - Dimension (WxHxD): 787.5 × 505.1 × 80.5 (mm)
 - Weight: 7.8 kg
- With TV stand
 - Dimension (WxHxD): 787.5 × 547.26 × 221.43 (mm)
 - Weight: 9.4 kg

26PDL49x6H

- Without TV stand
 - Dimension (WxHxD): 641.5 × 428.3 × 38.7 (mm)
 - Weight: 8.30 kg
- With TV stand
 - Dimension (WxHxD): 641.5 × 428.3 × 166.4 (mm)
 - Weight: 8.98 kg

22PDL49x6H

- Without TV stand
 - Dimension (WxHxD): 532.5 × 357 × 36.6 (mm)
 - Weight: 5.6 kg
- With TV stand
 - Dimension (WxHxD): 532.5 × 357 × 127 (mm)
 - Weight: 5.9 kg

9 Troubleshooting

This section describes commonly encountered issues and accompanying solutions.

General TV issues

The TV does not switch on:

- Disconnect the power cable from the power outlet. Wait for one minute then reconnect it.
- Check that the power cable is securely connected.

The remote control is not working properly:

- Check that the remote control batteries are correctly inserted according to the +/- orientation.
- Replace the remote control batteries if they are flat or weak.
- Clean the remote control and TV sensor lens.

The standby light on the TV blinks red:

- Disconnect the power cable from the power outlet. Wait until the TV cools down before reconnecting the power cable. If the blinking reoccurs, contact Philips Consumer Care.

You forgot the code to unlock the TV lock feature

- Enter '8888'.

The TV menu is in the wrong language.

- Change the TV menu to your preferred language.

When turning the TV on/off/to standby, you hear a creaking sound from the TV chassis:

- No action is required. The creaking sound is normal expansion and contraction of the TV as it cools down and warms up. This does not impact performance.

Cannot remove 'e-sticker' banner displayed on the TV.

- To remove the logos and images, set the location of your TV to home.
 1. Press **▲**.
 2. Select **[Setup] > [TV settings] > [Preferences] > [Location]**.
 3. Select **[Home]** and press **OK**.

TV channel issues

Previously installed channels do not appear in the channel list:

- Check that the correct channel list is selected.

No digital channels were found during the installation:

- Check that the TV supports DVB-T, DVB-T Lite or DVB-C in your country.

Some channels are not automatically installed on my TV:

- During installation, make sure that you select the country where you are installing the TV.

Picture issues

The TV is on, but there is no picture:

- Check that the antenna is properly connected to the TV.
- Check that the correct device is selected as the TV source.

There is sound but no picture:

- Check that the picture settings are correctly set.

There is poor TV reception from an antenna connection:

- Check that the antenna is properly connected to the TV.
- Loudspeakers, unearthed audio devices, neon lights, high buildings and other large objects can influence reception quality. If possible, try to improve the reception quality by changing the antenna direction or moving devices away from the TV.

- If reception on only one channel is poor, fine tune this channel.

There is poor picture quality from connected devices:

- Check that the devices are connected properly.
- Check that the picture settings are correctly set.

The TV did not save your picture settings:

- Check that the TV location is set to the home setting. This mode offers you the flexibility to change and save settings.

The picture does not fit the screen; it is too big or too small:

- Try using a different picture format.

The picture position is incorrect:

- Picture signals from some devices may not fit the screen correctly. Check the signal output of the device.

Sound issues

There is a picture but sound quality is poor:



Note

- If no audio signal is detected, the TV automatically switches the audio output off — this does not indicate malfunction.

- Check that all cables are properly connected.
- Check that the volume is not set to 0.
- Check that the sound is not muted.

There is a picture but the sound quality is poor:

- Check that the sound settings are correctly set.

There is a picture but sound comes from one speaker only:

- Verify that sound balance is set to the centre.

HDMI connection issues

There are problems with HDMI devices:

- Note that HDCP (High-bandwidth Digital Content Protection) support can delay the time taken for a TV to display content from a HDMI device.
- If the TV does not recognise the HDMI device and no picture is displayed, try switching the source from one device to another and back again.
- If there are intermittent sound disruptions, check that output settings from the HDMI device are correct.
- If you use an HDMI-to-DVI adapter or HDMI-to-DVI cable, check that an additional audio cable is connected to **AUDIO IN** (mini-jack only).

Computer connection issues

The computer display on the TV is not stable:

- Check that your PC uses the supported resolution and refresh rate.
- Set the TV picture format to unscaled.

Contact us

If you cannot resolve your problem, refer to the FAQs for this product at www.philips.com/support.

If the problem remains unresolved, contact Philips Consumer Care in your country as listed in the Addendum.



Warning

- Do not attempt to repair the product yourself. This may cause severe injury, irreparable damage to your product or void your warranty.



Note

- Make a note of your TV model and serial number before you contact Philips. These numbers are printed on the back of the TV and on the packaging.

10 Index

A	
age rating	23
analogue channels	
language, change	24
audio language	24
<hr/>	
C	
CAM	
enable	37
Insert	37
care	5
channels	
channel list	11
favourites	20
install (automatic)	30
rearrange	32
rename	31
reorder	32
switch	11
update	30
child lock	23
clock	21
common interface	37
computer, see PC	36
Conditional Access Module	37
connect	
connect device	33
connect, PC	36
connect, USB	25
connectors	33, 35
controls	7
<hr/>	
D	
demo	29
devices	
add	14
watch	12
digital channels	
digital radio	27
language, change	24
subtitles	25
dimensions	42
<hr/>	
display, wallpaper	24
<hr/>	
E	
EasyLink	
control devices, from TV remote	38
enable	38
hear from other speakers	
automatically	39
manually	40
picture quality, retain	39
subtitled video, maximise view	39
switch to standby, all devices	40
Electronic Programme Guide	20
environmental care	
end of use	6
recycle	6
while you watch TV	6
EPG, menu	20
<hr/>	
F	
factory settings	29
favourites list, add	20
<hr/>	
H	
HDMI	33, 35
HDMI ARC	33
hearing impaired	18
high-definition (HD), content	33, 35
home menu	14
home mode	29
<hr/>	
I	
install	
install channels	
install channels (automatic)	30
<hr/>	
K	
kensington lock	40
<hr/>	
L	
language	
audio	24
menu	24

subtitles	24
location, home or shop	29
<hr/>	
M	
multimedia	25
multimedia, play files	25
mute TV speakers	40
<hr/>	
P	
PC, display resolutions	41
picture format	17
picture settings	16
Pixel Plus link	39
position the TV	29
power	41
<hr/>	
R	
recycle	6
reinstall TV	30
remote control	
onscreen	38
overview	8
rename channels	31
reorder channels	32
<hr/>	
S	
Scenea, see screen saver	24
Scenea, switch on	24
screen care	5
screen saver	24
settings	
assistant	15
picture	16
sound	18
shop mode	29
sleeptimer	22
smart picture	15
smart sound	17

software	
digital broadcast update	28
version	27
sound settings	18
specifications	41
standby	10
subtitle, language	25
subtitles	24
switch	10
switch TV on or off	10
<hr/>	

T	
teletext	
dual screen	19
enlarge	19
subpages	19
Table Of Pages	19
teletext 2.5	19
troubleshoot	44
<hr/>	

U	
universal access	18
<hr/>	

V	
visually impaired	18
volume	12
<hr/>	

W	
wall mount	42

Information about how to re-tune your TV during the digital TV switchover.

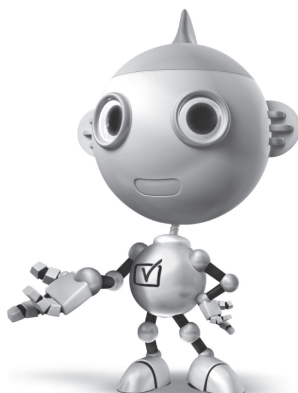

Television in the UK is going digital, bringing us all more choice and new services. Starting in late 2007 and ending in 2012, television services in the UK will go completely digital, TV region by TV region.

Please see the next page to find out when your area switches to digital.

Digital UK is the independent, non-profit organisation leading the process of digital TV switchover in the UK. Digital UK provides impartial information on what people need to do to prepare for the move to digital, and when they need to do it.

How the switchover affects your TV equipment:

Your new TV has a digital tuner built in, which means it is ready to receive the Freeview signal by simply plugging it into your aerial socket (check if you can get digital TV through your aerial now, or whether you'll have to wait until switchover, at www.digitaluk.co.uk).

When the TV switchover happens in your area, there are at least two occasions when you will need to re-tune your TV in order to continue receiving your existing TV channels, and also to pick up new ones.

get set for digital 

Digital UK, the body leading the digital TV switchover, will advise you when you need to re-tune during the switchover.

If you do not re-tune your channels when advised to do so by Digital UK, you may lose some or all of your channels until you do re-tune. You should re-tune your TV every few months to check for any new channels. If you choose to connect your TV to satellite or cable with a digital box then it will not be affected by switchover, and you won't need to re-tune.

If you have any questions, please contact your equipment supplier or call Digital UK on ... 0845 6 50 50 50 or visit www.digitaluk.co.uk

How to re-tune:

1. Press **▲** on the remote control.
2. Select **Setup** and press **OK**.
3. Select **Search for channels** and press **OK**.
4. Select **Reinstall channels** and press **OK**.
5. Select your country (UK) and press **OK**.
6. Select **Antenna DVB-T** and press **OK**.
7. Select **Start** and press **OK**.

The installation can take several minutes.

When the installation is complete, press **OK**. Your TV is now retuned.

If you are missing any channels, it may be that they are not available in your area, or that your aerial needs upgrading.

When does switchover happen?

*Copeland switches on October 17, 2007

The exact date you switch depends on the transmitter you are served by. To check when you switch, go to Digital UK's postcode checker on www.digitaluk.co.uk

Check your ITV news service or look at Teletext page 106 to see what TV region you're in.

Visit us at digitaluk.co.uk
Call us on 0845 6 50 50 50†

*Calls charged at BT rate of 3p per minute daytime and 1p per minute evenings and weekends. Rates may vary for calls from non-BT lines.

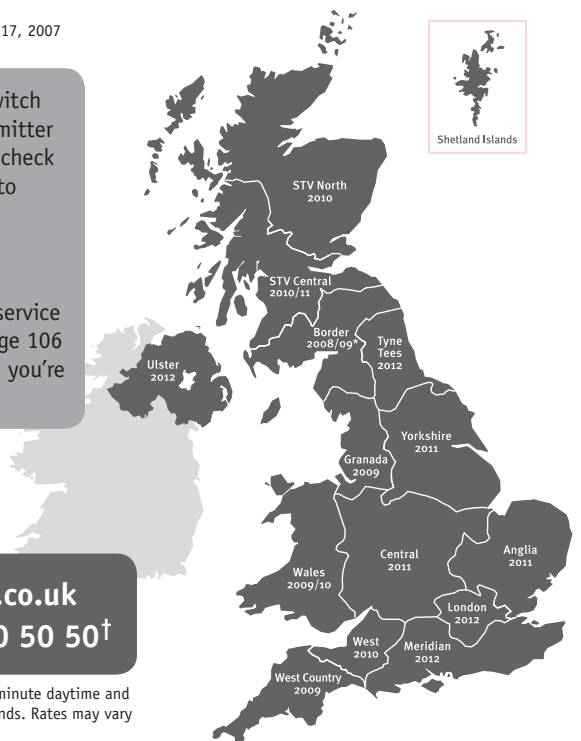



Contact information

Austria/Österreich

0820 40 11 33 (€ 0,145/min*)

*Aus dem österreichischen Festnetz. Kosten von anderen Netzbetreiber oder mobile können variieren

Belarus/Беларусь

8 10 800 2000 00 04

Belgium/België/Belgique

070 700 035 (€ 0,15/min*)

*Additionele kosten kunnen in rekening worden gebracht door uw (mobile) netwerk provider
*Sauf le surcoût éventuel selon opérateur du réseau mobile

Bulgaria/България

(02) 4916273 (national*)

*Polaczenia z tel. komórkowych zgodnie z taryfą operatora

Croatia/Hrvatska

+385 (01) 777 66 01

(national*)

*Za pozive iz mobilnih mreža vaš operater može zaračunati dodatne troškove

Czech Republic/Česká republika

228880895 (national*)

*Cena hovoru se řídí tarifem od Vašeho operátora

Denmark/Danmark

35 25 83 14

Estonia/Eesti Vabariik

6683061 (national*)

*Mobiilside operatoor võib kohaldada listasu vastavalt hinnakirjale

Finland/Suomi

09 88 62 50 40

France

01 57 32 40 50

(prix d'un appel national*)

*Sauf surcoût éventuel selon opérateur (mobile)

Germany/Deutschland

0180 501 04 69 (€ 0,14/min*)

*Aus dem deutschen Festnetz, Preis aus dem Mobilfunknetz maximal 0,42 €/Minute

Greece/Ελλάδα

2111983028 (national*)

*Μπορεί να έχετε μεγαλύτερο κόστος αν καλέτε από κινητό

Hungary/Magyarország

(06 1) 700 8151 (national*)

*telefonos (mobil) szolgáltatója részéről további költségek jelentkehetnek

Republic of Ireland/Poblacht na hÉireann

0818 210 140 (national*)

*Additional cost may be applied by your (mobile) network provider

Northern Ireland/Tuaisceart Éireann

0844 338 04 88 (0,05 GBP*)

*Calls cost 5 Pence/min from a BT landline — other providers and mobile networks may charge more. Check with your provider.

Italy/Italia

0245 28 70 14

(chiamata nazionale*)

*Potrebbero essere applicati costi addizionali se previsti dal tuo piano tariffario

Kazakhstan/Қазақстан

8 10 800 2000 00 04

Latvia/Latvija

6616 3263 (national*)

*Maksa par zvanu saskaņā ar Jūsu mobilā operatora tarifem

Lithuania/Lietuva

8 5 214 0293 (national*)

*Gali būti taikomas papildomas Jūsų mobilijoje operatoriaus mokesčiai

Luxembourg/Luxemburg

24871100 (national*)

*Additional cost may be applied by your (mobile) network provider

Netherlands/Nederlands

0900 202 08 71 (€ 0,10/min*)

*Additionele kosten kunnen in rekening worden gebracht door uw (mobile) netwerk provider

Norway/Norge

22 97 19 14

Poland/Polska

22 397 15 04 (national*)

*Polaczenia z tel. komórkowych zgodnie z taryfą operatora

Portugal

707 78 02 25

(0,12€ (0,30€ móvel)*)

*Custos adicionais podem ser cobrados pelo seu operador de rede móvel

Romania/România

031 6300042

(Luni – Vineri: orele 8 – 18*)

*Costuri suplimentare pot fi aplicate de către furnizorul dvs. de telefonie (mobilă)

Russia/Россия

8-800-22 00004

Serbia/Srbija

00381 11 2440841

Slovakia/Slovensko

2 332 154 93 (national*)

*Cena hovoru závisí od vášho operátora (mobilnej) siete

Slovenia/Slovenija

1 888 83 12 (national*)

*Za klice iz mobilnih omrežij lahko vaš operater zaračuna dodatne stroške

Spain/España

902 88 10 83

(0,10€ establecimiento de llamada + 0,08€/min*)

*Su operador móvil puede cargar costes adicionales en esta llamada

Sweden/Sverige

08-5792 9096

Switzerland/Schweiz/Suisse

0848 000 291

(0,081 CHF/min*)

*Aus dem Schweizer Festnetz, der Preis kann für Anrufe aus dem Mobilfunknetz abweichen

Turkey/Türkiye

444 8 445

Ukraine/Україна

0-800-500-480

(усі дзвінки зі стаціонарних телефонів у межах України безкоштовні)

United Kingdom

0844 338 04 88

(0,05 GBP/min*)

*Calls cost 5 Pence/min from a BT landline — other providers and mobile networks may charge more. Check with your provider.

Argentina

0810-444-7782

(Buenos Aires city)

0800-444-7749

(rest of country)

Brazil/Brasil

0800 701 0245

(Suporte a consumidores das demais localidades)

2938 0245

(Para consumidores da Grande São Paulo)

Middle East and Africa

800 7445477

South Africa

087 808 4456

Australia

1300 363 391

Hong Kong/香港

(852)26199660

India/भारत

1860 180 1111

Indonesia

(021)-7940040

Korea/한국

080-600-6600

Malaysia

1800 220 180

New Zealand

0800 658 224

Pakistan/پاکستان

(051)-580902-3

Philippines/Pilipinas

(632) 667 9000

Singapore/新加坡

62867333

Taiwan/台灣

0800 231 099

Thailand/ประเทศไทย

02 652 7650

Vietnam/Việt Nam

1800.59.99.88

