

Register your product and get support at
www.philips.com/TVsupport

22PFT5403

EN User manual

PHILIPS

Table of contents

1	Caution	2
----------	----------------	----------

2	Important	3
	Safety	3

3	Overview of your TV	5
	Remote control	5
	Using the remote control	6

4	Using the TV	7
	Switching the TV on or off	7
	Switching channels	7
	Adjusting the TV volume	8

5	Other uses of the TV	9
	Accessing the TV menu	9
	Changing the picture and sound settings	9
	Function settings	10
	Using the timer	11
	Adjusting VGA settings	12
	Playing multimedia files from USB devices	12
	Updating the TV software	13
	Restoring factory settings	13

6	Setting up channels	14
	Setting up channels automatically	14
	EPG	14
	Recording option	15
	Time-shift option	15

7	Connecting the TV	16
	Rear ports	16
	Side ports	16
	Connecting to a computer	17
	Using Philips EasyLink	18

8	Product information	19
	Display resolutions	19
	Multimedia	19
	Audio output power	19
	Intrinsic resolution	19
	Tuner/reception/transmission:	19
	Remote control	19
	Power supply	19
	Wall Mounting	20

9	Troubleshooting	21
	General issues	21
	Channel issues	21
	Picture issues	21
	Sound issues	22
	HDMI connection issues	22
	Computer connection issues	22
	Contact us	22

10	Environmental	23
	End of Use	23
	E-Waste Declaration for India	23
	Restriction on Hazardous Substances statement	24
	BEE Energy star	24

1 Caution

2018©TP Vision Europe B.V. All rights reserved. Specifications are subject to change without notice. All trademarks are the property of Koninklijke Philips N.V. or their respective owners. TP Vision Europe B.V. reserves the right to change products at any time without being obliged to adjust previously supplied products. The material in this manual is adequate for the intended use of the system. If the product, or its individual modules or procedures, are used for purposes other than those specified herein, their validity and suitability must first be confirmed. TP Vision Europe B.V. warrants that the material itself does not infringe upon any patents from the United States. No further warranty is expressed or implied. TP Vision Europe B.V. accepts no responsibility for any errors in the content of this document, nor for any issues that arise due to the content of this document. Errors reported to Philips will be rectified and published on the Philips support website as quickly as possible.

Warranty terms

- Risk of injury, damage to the TV or voided warranty! Never attempt to repair the TV yourself.
- Please only use the TV and accessories as set out by the manufacturer.
- The caution sign printed on the back of the TV indicates the risk of electric shock. Never remove the TV cover. Please contact Philips Customer Support if repairs are needed.
- Operations expressly prohibited in this manual, or any adjustments and assembly steps that are not recommended or authorised in this manual, are not within the scope of the warranty.

Pixel characteristics

This LCD/LED product has a high number of colour pixels. Although its proportion of effective pixels is 99.999% or more, black dots or bright points of light (red, green or blue) may appear persistently on the screen. This is a structural property of the display (within common industry standards), and is not a fault.

Copyright



®Kensington and Micro Saver are registered US trademarks of ACCO World Corporation with issued registrations and pending applications in other countries and regions throughout the world.



HDMI, the HDMI logo and High-Definition Multimedia Interface are trademarks or registered trademarks of HDMI Licensing LLC in the United States and other countries and regions.



This product is manufactured under license from Dolby Laboratories. Dolby, Dolby Audio and the double-D symbol are registered trademarks of Dolby Laboratories.

All other registered and unregistered trademarks are the property of their respective owners.

2 Important

Please read and make sure you understand all instructions before using the TV. Damage caused by a failure to follow the instructions is not covered by the warranty.

Safety

Risk of electric shock or fire!

- Never expose the TV to rain or water; Never place liquid containers (such as vases) next to the TV. If liquids are spilt on or inside the TV, disconnect the TV from the power supply immediately. Contact the Philips Customer Service Centre to have the TV checked before you use it again.
- Never place the TV, remote control or batteries near naked flames or other heat sources (including direct sunlight). To avoid fire spreading, always keep candles or other naked flames away from the TV, remote control and batteries.



- Never insert any objects into the ventilation slots or other openings on the TV.
- Make sure that no strain is placed on the power cable when swivelling the TV. Strain on the power cable can loosen connections and cause arcing.
- The power plug of the TV must be disconnected to disconnect the TV from the mains supply. When you disconnect the power, always pull out the power plug, and never the cable. Ensure that the power plug, power cable and outlet socket are accessible at all times.
- The power plug is a disconnection device and should be kept so that it is easy to operate.

Risk of short circuit or fire!

- Never expose the remote control or batteries to rain, water or excessive heat.
- Avoid pulling the power plug. Loose power plugs can lead to arcing or fire.

Risk of personal injury or damage to the TV!

- TVs weighing more than 25 kg must be carried by at least two people.
- Use the stand supplied when mounting the TV on a stand. Secure the TV to the stand tightly. Place the TV on a flat, level surface that can bear the weight of the TV and the stand.
- When mounting the TV on a wall, use a wall mount that can bear the weight of the TV. Secure the wall mount bracket to a wall that can bear the total weight of the TV and the wall mount. TP Vision Europe B.V. accepts no responsibility for improper wall mounting leading to accident, injury or damage.
- Remove the stand from the TV when storing the TV. Never place the TV face down with the stand attached.
- Before connecting the TV to the power outlet, make sure that the power voltage matches the value printed on the back of the TV. Never connect the TV to the power outlet if the voltages do not match.
- This product contains glass parts. Handle with care to avoid injury or damage.

Risk of injury to children!

Follow these precautions to prevent the TV from toppling over and injuring children:

- Never place the TV on a surface covered by a cloth or other material that can be pulled away.
- Make sure that no part of the TV hangs over the edge of the supporting surface.
- When you place the TV on high furniture (such as a bookcase), both the furniture and the TV must be secured either to the wall or a suitable support.
- Educate children on the dangers of climbing on furniture to reach the TV.

Risk of swallowing batteries!

- The product/remote control may contain coin-type batteries, which can easily be swallowed. Keep these batteries out of reach of small children at all times!

Risk of overheating!

- Never install the TV in a confined space. Leave a space of at least 4 inches (10 cm) around the TV for ventilation. Ensure that the ventilation slots on the TV are not covered by curtains or other objects.

Risk of injury, fire or power cord damage!

- Never place the TV or any objects on the power cable.
- Disconnect the TV from the power outlet and antenna before lightning storms. During lightning storms, never touch any part of the TV, power cable or antenna.

Risk of damage to hearing!

- Avoid the use of earphones or headphones at high volume for prolonged periods.

Low temperatures

- If the TV is transported in temperatures below 5°C (41°F), unpack the TV and wait for it to reach room temperature before connecting the TV to the power outlet.

- Displaying static images from video games and computers for extended periods may cause an afterimage and ghosting due to screen burn. Reduce the screen brightness and contrast accordingly when using the TV in this way.

Any afterimages, ghosting or marks displayed on the TV screen due to the causes mentioned above are not covered by the warranty.

Screen care

- Avoid static images as much as possible. Static images are images that remain onscreen for extended periods. Examples include onscreen menus, black bars and time displays. If you must use static images, reduce the screen contrast and brightness to avoid screen damage.
- Unplug the TV before cleaning.
- Use a soft damp cloth to wipe the TV and frame. Never use substances such as alcohol, chemical products or household cleaners to clean the TV.
- Risk of damage to the screen! Never touch, push, rub or strike the screen with an object.
- Wipe off any water as quickly as possible to avoid deformation and discolouration.



Note

Static images may cause permanent damage to the TV screen.

- Do not display static images on LCD TV screens for longer than 2 hours, as this can cause ghosting onscreen. To prevent ghosting, reduce the brightness and contrast of the screen when displaying static images.
- Watching programmes in 4:3 format for extended periods may leave different marks on the left and right of the screen and the border of the image. Therefore, avoid using this mode for prolonged periods.

3 Overview of your TV

Congratulations on your purchase and welcome to Philips! To fully benefit from the support offered by Philips, please register your TV at www.philips.com/welcome.

Remote control

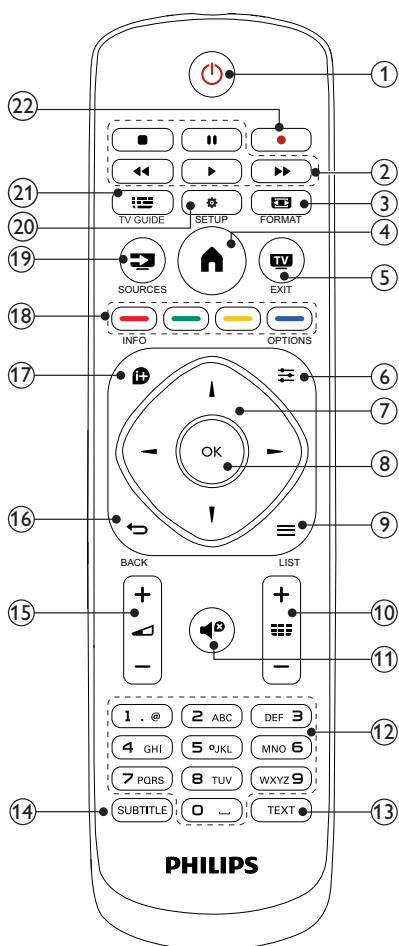

- ① **⏻ (Standby/On)**
Switches the TV on or returns it to standby.
- ② **Play buttons**
Control video, music or text.
- ③ **TV GUIDE**
Changes the picture format.
- ④ **🏠 (Home)**
Opens or closes the main menu and returns to the previous menu.
- ⑤ **TV EXIT**
Switches back to TV programme.
- ⑥ **≡ OPTIONS**
Selects audio track options while in TV mode.
- ⑦ **▲ ▼ ◀ ▶ (Navigation buttons)**
Navigates between menus and selects options.
- ⑧ **OK**
Confirms an entry or selection.
- ⑨ **≡ LIST**
Opens or closes the TV channel list.
- ⑩ **CH +/- (Channel +/-)**
Changes channels. Switches to the previous/next function when a USB device is connected.
- ⑪ **🔇 (Mute)**
Mutes or restores audio.
- ⑫ **0-9 (Numeric buttons 0-9)**
Select channels.
- ⑬ **TEXT**
Enables or disables teletext*.
- ⑭ **SUBTITLE**
Selects subtitles.
- ⑮ **+/- (Volume)**
Adjusts the volume.
- ⑯ **↶ BACK**
Returns to the previous menu or exits a function and switches to the previous channel.
- ⑰ **ℹ️ INFO**
Displays information on the current programme.
- ⑱ **Color buttons**

Select tasks or options.

- 19 **SOURCES**
Selects connected devices.
- 20 **SETUP**
Accesses the TV setup menu.
- 21 **TV GUIDE**
Opens or closes the TV guide.
- 22 **Red dot**
Used for recording

* Teletext or Austext is no longer available. However, one teletext option, "closed captions", is still working on most Australian television channels. This service allows you to activate subtitles for television programs that provide them.

Using the remote control

To use the remote control, hold it within range of the TV and point at the remote control sensor. Make sure that the line of sight between the remote control and the TV is not blocked by furniture, walls or other objects.

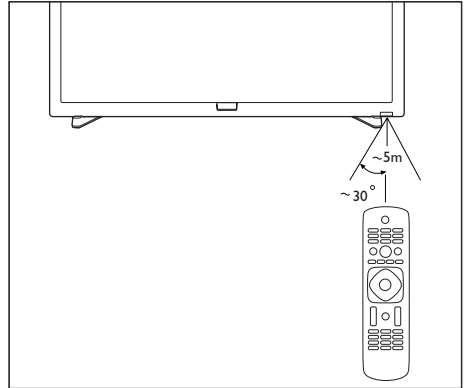

4 Using the TV

This section helps you to perform basic TV operations.

Switching the TV on or off

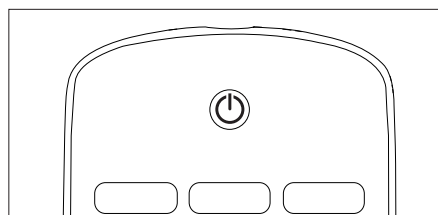
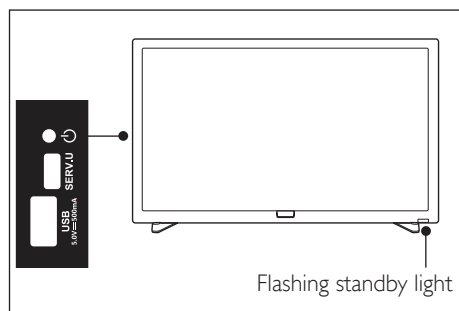

Switching the TV on

- Plug in the power plug.
 - ↳ If the standby indicator is red, press **⏻ (Standby/On)** on the remote control or on the back panel.

Switching to standby

- Press **⏻ (Standby/On)** on the remote control or on the back panel.
 - ↳ The standby indicator will change to red.



Tip

- Although your TV consumes very little power when in standby mode, it will continue to use some power. If you are not using your TV for an extended period, disconnect the TV power cable from the power outlet.

Switching channels

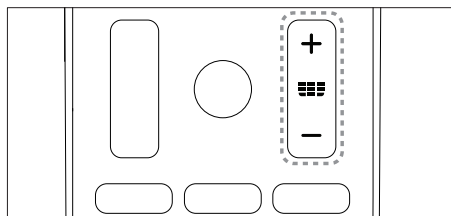

- Press **CH+/-** on the remote control.
- Enter a channel number using the numeric buttons on the remote control.
- Press **↶** on the remote control to return to the previous channel.

Viewing installed channels

All available channels can be viewed in the channel list.

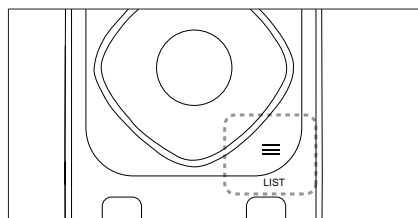

- 1 Press **≡ LIST**.
↳ The channel list is displayed.
- 2 Press **▲▼** to select channels and to browse the channel list.
- 3 Press **OK** to watch the selected channel.
- 4 Press **↶** to switch and return to the channel watched last.

Watch from connected devices



Note

- Turn on the device before selecting it as an external signal source.

Using the SOURCES button

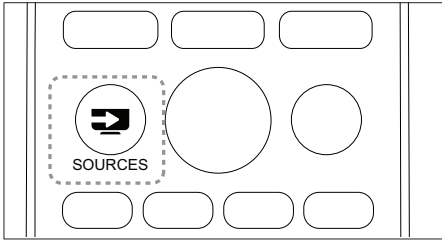

- 1 Press **SOURCES**.
↳ The sources list is displayed.
- 2 Press to select a device.
- 3 Press **OK** to confirm.
↳ The TV switches to the selected device.

Adjusting the TV volume

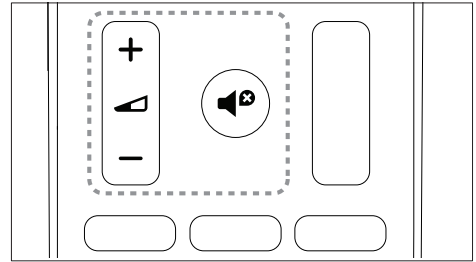

Increasing or decreasing the volume

- Press **VOL +/-** on the remote control.

To mute or unmute sound

- Press (**Mute**).
- Press again to restore the sound.

5 Other uses of the TV

Accessing the TV menu

The menu helps you set up channels, change the picture and sound settings, and access other functions.

- 1 Press **Home** .
↳ The menu screen is displayed.

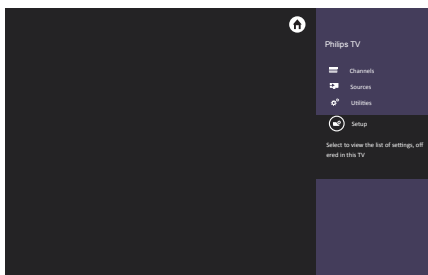

- 2 Select **[Setup]**.
- 3 Press **▲▼◀▶** to select from the following options:
 - **[Picture]** / **[Sound]** / **[TV]** (only shown in TV mode) / **[Settings]** / **[Parental]** (only shown in TV mode) / **[VGA Setting]** (can only be used in PC mode) / **[EasyLink]**.
- 4 Press **OK** to confirm.
- 5 Press **Home** to exit or return to the previous menu.

Changing the picture and sound settings





You can change the picture and sound settings to suit your preferences. You can use the preset settings or manually adjust the settings.

Adjusting the picture settings

- 1 Press **Home** and select **[Setup]** to enter the **[Setup]** menu. Then select **[Picture]**.
↳ The **[Picture]** menu is displayed.
- 2 Press **▲▼◀▶** to select/adjust the settings:
 - **[Smart Picture]:**
 - **[Standard]:** standard picture settings. This option is recommended for home entertainment use.
 - **[Vivid]:** increases the contrast and sharpness of the picture.
 - **[Movie]:** applies to film settings and works best in a home cinema environment.
 - **[Natural]:** increases the softness of the picture.
 - **[Personal]:** you can customise your settings with this option.
 - **[Brightness]:** adjusts the intensity and detail of dark areas (the adjustments made can only be saved in personal settings).
 - **[Video Contrast]:** adjusts the intensity and detail of bright areas, while dark areas remain unchanged (the adjustments made can only be saved in personal settings).
 - **[Color]:** adjusts the colour saturation (the adjustments made can only be saved in personal settings).
 - **[Tint]:** adjusts the level of green (this option only appears when using the NTSC system).
 - **[Sharpness]:** adjusts the sharpness of the image (the adjustments made can only be saved in personal settings).
 - **[Color Temperature]:**
 - **[Cool]:** gives a bluish-white hue.
 - **[Normal]:** gives a white hue. Users can customise the white hue when in PC mode.
 - **[Warm]:** gives a reddish-white hue.
 - **[Advance Control]:**
 - **[Noise Reduction]:** filters and eliminates signal noise in the image.
 - **[Backlight]:** adjusts the screen brightness (when the backlight is set to a low value, a brief white flicker may be seen when switching the TV on. This is normal).
 - **[Dynamic Contrast]:** sets the contrast to maximum.
 - **[Dynamic Backlight]:** the contrast changes with the brightness of the image.





- Options may vary for pictures from different sources.

Adjusting the sound settings

- 1  Press **(Home)** and select **[Setup]** to enter the **[Setup]** menu. Select **[Sound]**.
↳ The **[Sound]** menu is displayed.
- 2 Press     to select and adjust the settings:
 - **[Smart Sound]:**
 - **[Standard]:** gives balanced, outstanding sound performance in the treble, mid and bass ranges.
 - **[Music]:** enhances treble and bass, delivering bright, clear, pure sound for piano or orchestral instrument performances.
 - **[Movie]:** enhances film sound effects, allowing you to enjoy a home cinema-like effect.
 - **[Speech]:** enhances the performance of sound ranges associated with the human voice spectrum. This option is suitable for watching news or arts programmes.
 - **[Flat]:** enhances the smoothness of the sound output, creating a softer sound.
 - **[Personal]:** provides users with customisation functions so that all sound effect parameters are optimised to create the best possible experience.
 - **[Balance]:** adjusts the balance of the left and right speakers.
 - **[Bass]:** adjusts the base level (the adjustments made can only be saved in personal settings).
 - **[Treble]:** adjusts the treble level (the adjustments made can only be saved in personal settings).
 - **[Virtual Surround]:** enables virtual surround sound: switching on or off.
 - **[AVL]:** turns automatic volume adjustment on when switching channels.
 - **[TVSpeakers]:** turns sound on the TV on and off.
 - **[Clear Sound]:** turns speech on and off.

- **[TV Placement]:** adjusts the means of the TV placement.

Function settings

- 1 Press  **(Home)** and select **[Setup]** to enter the **[Setup]** menu. Then select **[Settings]**.
↳ The **[Settings]** menu is displayed.
- 2 Press     to select and adjust the settings:
 - **[Menu Language]:** adjusts the language settings of the TV.
 - **[Picture Format]:** the majority of signals use 16:9, 4:3, zoom 1 and zoom 2 formats. HDMI signal sources use 16:9, 4:3, Point to Point, zoom 1 and zoom 2 formats. PC VGA signal sources use 16:9, 4:3 and Point to Point formats.
 - **[Menu Timeout]:** sets how long the menu is displayed.
 - **[Blue Screen]:** sets the colour of the screen when the TV receives no signal (when the TV signal is not functioning).
 - **[Auto Sleep]:** sets how long the TV must be idle for before switching off automatically (not applicable to PC mode).
 - **[Sleep Timer]:** sets when the TV automatically enters standby mode. The options are: off/10/20/30/60/90/180 minutes..
 - **[Time Setup]:** sets the system time.
 - **[Color System]:** sets the AV colour system (only displayed in AV mode).
 - **[HDMI Mode]:** sets the HDMI mode (only displayed in 480p/576p/720p/1080p HDMI modes).
 - **[PVR File System]:** before carrying out PVR operations, the USB flash drive must be formatted and memory space allocated.
 - **[Reinstall TV]:** restores all settings to default and reopens the installation wizard menu.
 - **[Reset]:** restores the default settings (excluding password settings and channel information).
 - **[Software Version]:** checks the current software version.

Changing the picture format

- 1 Press **⏠** (Home) and select **[Setup]** to enter the **[Setup]** menu. Then select **[Settings]**.
- 2 Press **▲▼◀▶** to select **[Picture Format]**.
- 3 Select a **picture format**.
- 4 Press **OK** to confirm.

Summary of picture formats

The following picture formats can be configured.

Note

- Some picture settings may be unavailable due to differences between picture signal formats.



[16:9]: adjusts the normal standard ratio to a widescreen format.



[4:3]: the normal standard format.



[Zoom 1]: horizontal scaling for the widescreen picture format. When this format is used, the left and right of the frame will be partially cut off.

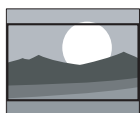

[Zoom 2]: adjusts the standard ratio to a widescreen format (only 16:9, 4:3 and Point to Point options are available in PC mode).



[Point to Point]: used for HDMI connections with PCs. This displays the full PC screen to achieve the best display results.

Using the timer

You can set the timer to switch the TV to standby mode at a set time.

Tip

- Set the sleep timer before using the timer function.

Setting the sleep timer

Tip

- You can turn the TV off in advance or reset the sleep timer when the timer is up.

- 1 Press **⏠** (Home) and select **[Setup]** to enter the **[Setup]** menu. Then select **[Settings]**.
- 2 Press **▲▼◀▶** to select **[Sleep Timer]**.
- 3 Press **▲▼** to select a time for the sleep timer to switch the TV off.
 - ↳ The longest time that the sleep timer can be set for is 180 minutes.

TV lock

By locking the TV remote control, you can prevent children from watching specific programmes or channels.

Setting or changing your password

- 1 Press **⏠** (Home) and select **[Setup]** to enter the **[Setup]** menu. Then select **[Parental]**.
- 2 Enter the password using the numeric buttons on the remote control.
- 3 Select **[Change Password]** and follow the instructions onscreen to change the password.

Locking channels

- 1 Press **⏠** (Home) and select **[Setup]** to enter the **[Setup]** menu. Then select **[Parental]**.
- 2 Enter the password and select **[Parental Rating]**.
- 3 Adjust the channel locking rating.

4 Repeat this step to adjust the channel ratings.

- **[Parental Rating]:** when channels are locked:
 - Enter the four-digit password to access the channel blocking menu.
 - Enter the four-digit password to view locked channels.
 - Enter the four-digit password to access the parental lock menu.
- **[Clear All]:** this function will clear all previously saved locked channels and signal sources.
 - The default password is '0000'. Users may change or set the password themselves.



Note

- If you go to a locked channel, you will be prompted to enter the password.

Playing multimedia files from USB devices

You can play photo, music or video files stored on a USB storage device on your TV.

- Supported storage devices: USB (only FAT or FAT 32 USB storage devices are supported)
- Supported multimedia file formats:
 - Images: JPEG
 - Audio: MP3
 - Video: MPEG 2/MPEG 4, H.264
 - Documents: TXT



Note

- TPVision assumes no responsibility if a USB storage device is not supported, or if the data on the device is damaged or lost.

Adjusting VGA settings

1 Press Press **(Home)** and select **[Setup]** to enter the **[Setup]** menu. Then select **[VGA Setting]**.

↳ The **[VGA Setting]** menu is displayed.

2 Press to select and adjust the settings:

- **[Auto Adjust]:** automatically adjusts the TV to synchronise its resolution with that of the PC, so that programmes are displayed in full screen.
- **[H.Position]:** adjusts the horizontal position.
- **[V.Position]:** adjusts the vertical position.
- **[Phase]:** adjusts the phase frequency of the VGA signal.
- **[Clock]:** adjusts the clock frequency of the VGA signal.



Tip

- The **[VGA Setting]** menu can only be used when connected to a PC.

Viewing photos and text files and playing audio and video files

1 Turn the TV on.

2 Connect the USB storage device to the USB port on the side of the TV.

3 Press (**SOURCES**).

4 Select **[USB]** and press **OK**.



↳ The USB browser will open.

Viewing photos

- 1 Select the photo within the USB browser and press **OK**. The photo will be enlarged to fill the screen.
- Press **CH-** or **CH+** to see either the previous or the next photo.

Starting slide shows

- 1 Select a photo or folder and then press **OK**. The photo will be enlarged to fill the screen.
- ↳ The slide show will start playing from the selected photo.

- 2 Press the following buttons to control the playback of photos:
 -  or : play or pause
 - **CH-** or **CH+**: view either the previous or the next photo.

Changing the slide show settings







To start playing a slide show, press  (**Option**) and select one of the following options, then press **OK**.

- **[Rotate]**: sets the images to rotate.
- **[Duration]**: sets the duration of the slide show.







Listening to music

- 1 In the USB browser, select a song or album. Then press **OK** to begin playing.

Changing the music settings





-  or : to play or pause.
- /: switches to the previous/next song.
- /: for rewinding or fast forwarding.

Watching videos

- 1 Select the video file in the USB browser, then press **OK** to play the video.
- 2 The following buttons are used to control the film:
 -  or : to play or pause.
 - /: move to the previous or next one.
 - /: for rewinding or fast forwarding.

Viewing text files

- 1 Select the text file in the USB browser, then press **OK** to view the document.

- 2 The following buttons are used to control the text playback:
 -  or : to play or pause
 - /: to go back 20 pages or move on 20 pages.

Removing USB storage devices

Note

- Follow the steps below to avoid damaging the USB storage device.





- 1 Hold down  to exit the USB browser.
- 2 Wait around 5 minutes before removing the USB storage device.

Updating the TV software

Philips constantly strives to improve its products, and so we recommend that you update your TV software whenever an update is released. Visit www.philips.com/support to check whether updates are available.

Restoring factory settings

You can restore the default picture and sound settings for your TV without affecting the saved channel set up.

- 1 Press  (**Home**) and select **[Setup]** to enter the **[Setup]** menu
- 2 Press    Then select **[Settings] > [Reset]**.
- 3 Select **[Yes]** and press **OK**. If you wish to cancel, select **[No]** and press **OK**.

6 Setting up channels

This chapter explains how to reconfigure and fine-tune channels.

Setting up channels automatically

This option automatically finds and saves channels.

- 1 Press **Home** and select **[Setup]** to enter the **[Setup]** menu
- 2 Press **▲▼◀▶** to select **[TV] > [Channels] > [Channel Scan]**.
- 3 Press **OK**.
↳ The TV will start searching for channels automatically.

EPG

- 1 Press **TV GUIDE** on the remote control to access TV program guide list (It is available only in DTV mode). In this program guide list, press **▲▼** to select the current time and date, and then press **◀▶** to view all programs information in the next 7 days of the future (Fig.1).

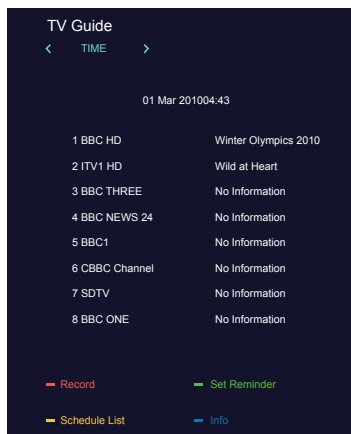

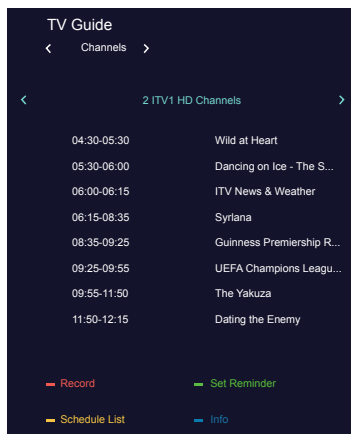

- 2 Press **◀▶** to select Channel in the top bar of guide list, then press **▲▼** to view a program information in the next 7 days of the future. Focus on the Channel bar you can press **◀▶** to view the other programs information (Fig.2).







You can select the color keys to edit these programs with the tips on the screen. The color keys introductions as below:

- **Record:** Press **Record** red key to record the program.
- **Remind:** Press **Set Reminder** green key to set remind the program.

- **Info:** Press  blue key to display the program information.
- **Schedule:** Press  yellow key to view program status in schedule list.

Recording option







In DTV mode, press  red dot on the remote control. Record option menu will show on the screen, and the TV system begin recording now.

- 1 Press  key to stop and quit the recording.
- 2 Press  (Home), select **[Utilities] > [Recordings]** to open the TV recorded list.
- 3 Press  green key to view the file information or delete it by pressing  red key, and press **OK** to play it normally.



Note

- This function need connect with USB device, the USB of FAT32 format must be used. The USB of NTFS format does not support recording. The duration of each recording should be no longer than 6 hours.

Recording options menu introduction







- : Play the current video.
- : Fast back for the video, press  (play) key to play normally.
- : Fast forward for the video, press  (play) key to play normally.
- : Pause the video.
- : Stop recording and quit the recording function.

Time-shift option

In DTV mode, press  (start) , time-shift option menu will show on the screen, and the program is in suspended status. press  to stop and quit time-shift function. When you leave program for

a short time, time-shift function can suspend and cache the playing program to U disk. When you resume playing, the program can continue to be played.

Time-shift options menu introduction

- : Play the current video.
- : Fast back for the video, press  (play) key to play normally.
- : Fast forward for the video, press  (play) key to play normally.
- : Pause the video.
- : Stop and quit time-shift function.

7 Connecting the TV

This section explains how to connect devices with different connectors.

Note

- You can use different connection types to connect devices to the TV.

- HDMI**
Digital audio and video input from high definition devices such as Blu-ray players.

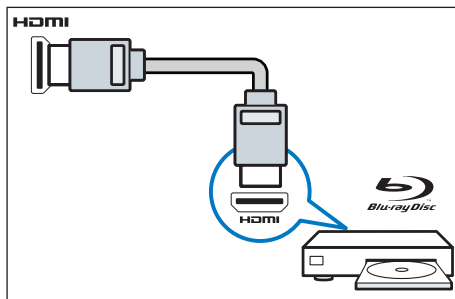

Rear ports

- Antenna/cable TV**
Input for an antenna, cable or satellite signal

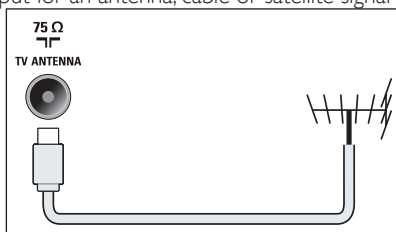

- PC inputs (VGA and audio)**

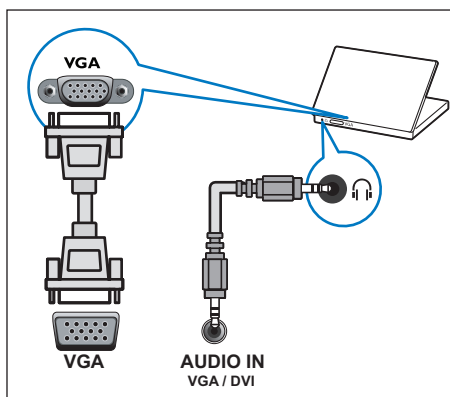

Side ports

- AV input**

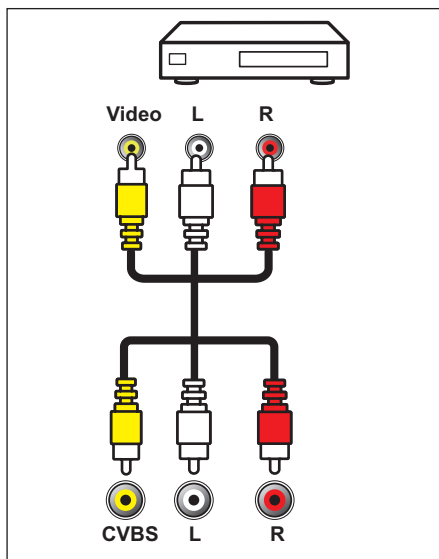

② USB

Data input from a USB storage device.

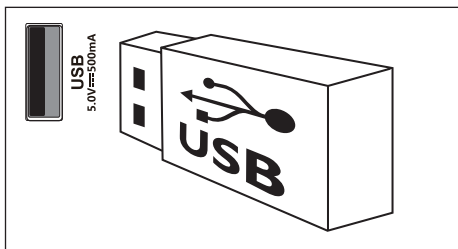

- Press ▲▼◀▶ to select **[Settings]** > **[Picture Format]**.
- Select a picture format.
- Press OK to confirm.

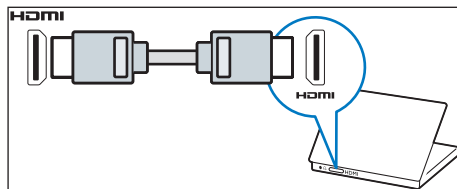

- DVI-HDMI cable

Connecting to a computer

Before connecting a computer to the TV:

- Set the computer screen refresh rate to 60 Hz.
- Select a supported screen resolution on the computer.

Connect to the computer using one of the following connections:

Note

- A separate audio cable is required when connecting via DVI or VGA.

- HDMI cable
- 1 Set the resolution of the computer display to 480p/576p/720p/1080p
 - 2 Press **⏠** (**Home**) and select **[Setup]** to enter the **[Setup]** menu.
 - 3 Press ▲▼◀▶ to select **[Settings]** > **[HDMI Mode]**, and set the HDMI display mode to graphics or video.
 - 4 Adjust the picture format to achieve the best display results.
 - Press **⏠** (**Home**) and select **[Setup]** to enter the **[Setup]** menu.

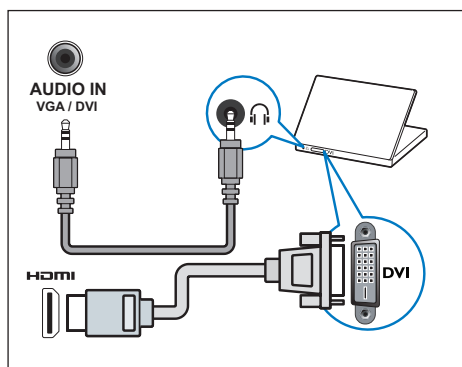

- HDMI cable and HDMI-DVI adapter

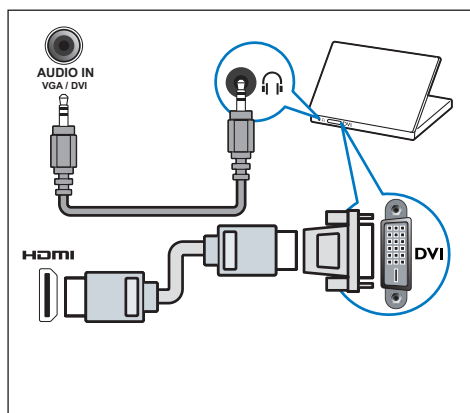

- VGA cable

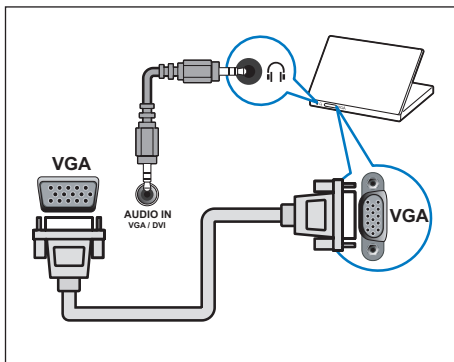

Using Philips EasyLink

Making full use of your Philips EasyLink HDMI-CEC compatible devices can enhance control features to achieve the best possible results. HDMI-CEC compatible devices connected through the HDMI connector can be controlled by a TV remote control.

To enable Philips EasyLink, you will need to:

- Connect two or more HDMI-CEC compatible devices using HDMI connections.
- Make sure that each HDMI-CEC compatible device is operating normally.
- Switch to EasyLink.

Note

- EasyLink compatible devices must be switched on and selected as a signal source.
- Philips does not guarantee 100% interoperability with all HDMI-CEC devices.

Enabling or disabling EasyLink

Once an HDMI-CEC compatible device has been switched on, the TV will automatically turn on and switch to the correct signal source.

Note

- Do not enable this function if you would prefer not to use Philips EasyLink.

- 1 Press **⏠** (Home) and select **[Setup]** to enter the **[Setup]** menu.
- 2 Press **▲▼◀▶** to select **[EasyLink] > [HDMI CEC]**.
- 3 Select **[Off]** or **[On]**, then press **OK**.

Using One-touch Play

- 1 Once EasyLink has been enabled, press play on the device.
 - ↳ The TV will automatically switch to the correct signal source.

Using One-touch Standby

- 1 Press **(Standby/On)** on the remote control.
 - ↳ The TV and all connected HDMI devices will automatically enter standby mode.

8 Product information

Product information is subject to change without notice. For detailed product information, visit www.philips.com/support.

Display resolutions

Computer formats

- Resolution - refresh rate:
 - 640 × 480 - 60Hz
 - 800 × 600 - 60Hz
 - 1024 × 768 - 60Hz
 - 1360 × 768 - 60Hz
 - 1920 × 1080 - 60Hz

Video formats

- Resolution - refresh rate:
 - 480i - 60Hz
 - 480p - 60Hz
 - 576i - 50Hz
 - 576p - 50Hz
 - 720p - 50Hz, 60Hz
 - 1080i - 50Hz, 60Hz
 - 1080p - 50Hz, 60Hz.

Multimedia

- Supported storage devices: USB (only FAT or FAT 32 USB storage devices are supported).
- Supported multimedia file formats:
 - Images: JPEG
 - Audio: MP3
 - Video: MPEG 2/MPEG 4, H.264
 - Documents: TXT

Audio output power

- 22PFT5403: 3W × 2

Intrinsic resolution

- 22PFT5403: 1920 × 1080

Tuner/reception/transmission:

- Antenna input: 75 ohm coaxial (IEC75)
- TV systems: NTSC, SECAM, PAL and DVB-T/T2
- Video playback: NTSC, SECAM and PAL

Remote control

- Batteries: 2 × AAA

Power supply

- Mains power: 110-240V, 50-60Hz
- Standby power: ≤ 0.6 W
- Ambient temperature: 5 to 40 degrees Celsius
- Power consumption: 22PFT5403: 42W

Wall Mounting

o mount the TV, please purchase a Philips TV mount or any TV mount compliant with the VESA standard. To prevent damage to cables and connectors, be sure to leave a clearance gap of at least 2.2 inches or 5.5cm between the back of the TV to the wall.



Caution

- Please follow all instructions provided with the TV mount. TP Vision Europe B.V. bears no responsibility for improper TV mounting that results in accident, injury or damage.

Model no.	Required pixel pitch (mm)	Required mounting screws
22PFT5403	100	2 × M4 (Minimum 12 mm, Maximum 14mm)

9 Troubleshooting

This section covers common problems and their corresponding solutions.

General issues

The TV does not switch on:

- Disconnect the power cable from the power outlet. Wait for one minute and then reconnect the cable.
- Check that the power cable is securely connected.

The remote control does not function normally:

- Check that the remote control batteries are correctly inserted according to the +/- orientation.
- Replace the batteries with new ones if they are flat or running low.
- Clean the remote control and the TV sensor lens.

The standby light on the TV is flashing red:

- Disconnect the power cable from the power outlet. Wait until the TV has cooled down before reconnecting the power cable. Contact the Philips Customer Service Centre if the light continues to flash.

You forget the code to unlock the TV functions:

- Enter '3448'.

The TV menu is in the wrong language:

- Change the TV menu to your preferred language.

You hear a creaking sound from the TV chassis when turning the TV on/off or to standby:

- No action is required. The creaking sound is due to the normal expansion and contraction of the TV as it cools down and warms up. This does not affect performance.

Channel issues

Previously installed channels do not appear in the channel list:

- Check that the correct channel list is selected.

Picture issues

The TV is on, but there is no picture:

- Check that the antenna is properly connected to the TV.
- Check that the correct device is selected as the TV source.

There is sound, but no picture:

- Check that the picture settings are set correctly.

Poor reception from the antenna connection:

- Check that the antenna is properly connected to the TV.
- Loud speakers, unearthed audio devices, neon lights, tall buildings and other large objects can affect reception quality. Try to improve the reception quality by changing the antenna direction or moving the aforementioned devices away from the TV.
- If the reception on one particular channel is poor, fine-tune this channel.

Poor picture quality from a connected device:

- Check that the device is connected properly.
- Check that the picture settings are set correctly.

The TV does not save the picture settings:

- Check that the TV location is set to the home setting. This mode gives you the flexibility to change and save settings.

The picture is either too big or too small and does not fit the screen:

- Try using a different picture format.

The picture position is incorrect:

- Picture signals from certain devices may not fit the screen correctly. Check the signal output of the device.

Sound issues

There is a picture but the sound quality is poor:

Note

- If no audio signal is detected, the TV will automatically switch the audio output off - this does not indicate a malfunction.

- Check that all cables are connected properly.
- Check that the volume is not set to 0.
- Check that the sound is not muted.
- Check that the sound settings are set correctly.

There is a picture, but sound only comes from one speaker:

- Check that the sound balance is set to the centre.

HDMI connection issues

There are problems with HDMI devices:

- Note that HDCP (High-bandwidth Digital Content Protection) support can delay the time taken for a TV to display content from an HDMI device.
- If the TV does not recognise the HDMI device and no picture is displayed, try switching the source from one device to another and back again.
- If there are intermittent sound disruptions, check that the HDMI device output settings are correct.
- If you use an HDMI-to-DVI adapter or cable, check whether the audio cable that comes with the product is connected to AUDIO (mini-jack only).

Computer connection issues

The computer display on the TV is not stable:

- Check that your PC is using the supported resolution and refresh rate.
- Set the TV picture format to unscaled.

Contact us

If you are unable to resolve your problem, please refer to the FAQs for this model at: www.philips.com/support.

If the problem remains unresolved after this, contact your local Philips Customer Service Centre.



Caution

- Do not attempt to repair the TV yourself. This may cause severe injury, irreparable damage to the TV or void your warranty.



Note

- Make a note of your TV model and serial number before contacting the Philips Customer Service Centre. These numbers are printed on the back/bottom of the TV and on the packaging.

10 Environmental

This section covers common problems and their corresponding solutions.

End of Use

Disposal of your old product and batteries

Your product is designed and manufactured with high quality materials and components, which can be recycled and reused.



When this crossed-out wheeled bin symbol is attached to a product it means that the product is covered by the European Directive 2012/19/EU.



Please inform yourself about the local separate collection system for electrical and electronic products.

Please act according to your local rules and do not dispose of your old products with your normal household waste. Correct disposal of your old product helps to prevent potential negative consequences for the environment and human health.

Your product contains batteries covered by the European Directive 2006/66/EC, which cannot be disposed with normal household waste.



Please find out for yourself about the local rules on separate collection of batteries because correct disposal will help to prevent negative consequences for the environment and human health.

E-Waste Declaration for India



This symbol on the product or on its packaging indicates that this product must not be disposed of with your other household waste. Instead it is your responsibility to dispose of your waste equipment by handing it over to a designated collection point for the recycling of waste electrical and electronic equipment.

The separate collection and recycling of your waste equipment at the time of disposal will help to conserve natural resources and ensure that it is recycled in a manner that protects human health and the environment. For more information about E-waste, please visit

<http://www.india.philips.com/about/sustainability/recycling/index.page> and to know where you can drop off your waste equipment for recycling in India, please contact on below given contact details.

Helpline number: 1800-425-6396 (Monday to Saturday, 9 am to 5:30 pm)

Restriction on Hazardous Substances statement

This product complies with the "E-Waste (Management) Rules, 2016" CHAPTER V, rule 16, sub-rule (1) .Whereas New Electrical and Electronic Equipment and their components or consumables or parts or spares do not contain Lead, Mercury, Cadmium, Hexavalent Chromium, polybrominated biphenyls and polybrominated diphenyl ethers beyond a maximum concentration value of 0.1% by weight in homogenous materials for lead, mercury, hexavalent chromium, polybrominated biphenyls and polybrominated diphenyl ethers and of 0.01% by weight in homogenous materials for cadmium. except of exemptions set in Schedule 2 of the Rule.

BEE Energy star

Below sentence is not applicable for above 1920x1080 resolution TV models.

ATTENTION

This product is qualified for the BEE Star rating in the 'Home' Mode. The Objectives of Star Labeling Program is designed to promote energy efficient products and practices.

When the television is initially set up, it is designed to meet the BEE Star Labeling requirements while maintaining optimum picture quality.

- Changes to certain functionalities of this television (TV Guide, Picture/sound etc.) may change the power consumption.
- Depending upon such changed setting (eg., Retail mode), the power consumption may vary which possibly could exceed the stated energy consumption.

To reset the television to Star rating qualified settings, select 'Home' mode from the initial set-up procedure in 'factory settings' under the 'Set-up' menu.

LED TV*

* Disclaimer

PHILIPS LED TV applies LCD screen with LED backlights.



All registered and unregistered trademarks are property of their respective owners. Specifications are subject to change without notice. Philips and the Philips' shield emblem are trademarks of Koninklijke Philips N.V. and are used under license from Koninklijke Philips N.V. 2018 © TP Vision Europe B.V. All rights reserved. philips.com