



19HFL3232D/10

22HFL3232D/10

26HFL3232D/10

EN User manual

PHILIPS



Country	Telephone number
Austria	0810000206
Belgium	078250851
Croatia	0800222782
Czech Republic	800142100
Denmark	35258761
Finland	0922901908
France	0821611658
Germany	01803386853
Greece	0080031221223
Hungary	0680018544
Ireland	016011161
Italy	0840320041
Luxembourg	026843000
Netherlands	09000400063
Norway	22708250
Poland	0223491505
Portugal	0800780902
Slovakia	0800004551
Slovenia	080080255
Spain	902888785
Sweden	086320016
Switzerland	0223102116
UK	02079490069

This information is correct at the time of press. For updated information, see www.philips.com/support.

Contents

1	Notice	2		
2	Important	4		
3	Your TV	7		
	Side controls and indicators	7		
	Remote control	8		
4	Use your TV	10		
	Switch your TV on / off or to standby	10		
	Switch channels	10		
	Watch connected devices	11		
	Adjust TV volume	11		
	Use teletext	11		
5	Use more of your TV	12		
	Access TV menus	12		
	Rename devices from the home menu	12		
	Remove devices from the home menu	13		
	Change picture and sound settings	13		
	Use the universal access menu	17		
	Use advanced teletext features	17		
	Create and use list of favourite channels	18		
	Use the Electronic Programme Guide	19		
	Use the TV clock	20		
	Use timers	21		
	Use TV locks	21		
	Use subtitles	23		
	View photos and play music from a USB storage device	24		
	Listen to digital radio channels	25		
	Update the TV software	26		
	Change TV preferences	26		
	Access decoder channel	27		
	Start a TV demo	27		
	Reset the TV to factory settings	27		
6	Install channels	28		
	Automatically install channels	28		
	Manually install channels	29		
	Rename channels	30		
	Rearrange channels	30		
	Test digital reception	30		
7	Professional mode instruction	31		
	Introduction	31		
	Benefits of Professional mode	31		
	Professional Setup Remote control (2573 optional)	31		
	Activating the Professional mode setup menu	32		
	Professional mode options	33		
8	Connect devices	41		
	Back connector	41		
	Side connector	42		
	Connect a computer	44		
	Use a Conditional Access Module	45		
	Use Philips EasyLink	46		
	Use a Kensington lock	47		
9	Product information	48		
	Supported display resolutions	48		
	Multimedia	48		
	Tuner / Reception / Transmission	48		
	Remote control	48		
	Power	48		
	Supported TV mounts	49		
	Product specification	49		
10	Troubleshooting	50		
	General TV issues	50		
	TV channel issues	50		
	Picture issues	50		
	Sound issues	51		
	HDMI connection issues	51		
	Computer connection issues	51		
	Contact us	51		

1 Notice

2010 © Koninklijke Philips Electronics N.V. All rights reserved.

Specifications are subject to change without notice. Trademarks are the property of Koninklijke Philips Electronics N.V or their respective owners. Philips reserves the right to change products at any time without being obliged to adjust earlier supplies accordingly. The material in this manual is believed adequate for the intended use of the system. If the product, or its individual modules or procedures, are used for purposes other than those specified herein, confirmation of their validity and suitability must be obtained. Philips warrants that the material itself does not infringe any United States patents. No further warranty is expressed or implied.

Warranty

- Risk of injury, damage to TV or void of warranty! Never attempt to repair the TV yourself.
- Use the TV and accessories only as intended by the manufacturer.
- The caution sign printed on the back of the TV indicates risk of electric shock. Never remove the TV cover. Always contact Philips Customer Support for service or repairs.



Any operation expressly prohibited in this manual, or any adjustments and assembly procedures not recommended or authorised in this manual shall void the warranty.

Pixel characteristics

This LCD product has a high number of colour pixels. Although it has effective pixels of 99.999% or more, black dots or bright points of light (red, green or blue) may appear constantly on the screen. This is a structural property of the display (within common industry standards) and is not a malfunction.

Compliance with EMF

Koninklijke Philips Electronics N.V. manufactures and sells many products targeted at consumers which, like any electronic apparatus, in general have the ability to emit and receive electromagnetic signals. One of Philips' leading Business Principles is to take all necessary health and safety measures for our products, to comply with all applicable legal requirements and to stay well within the EMF standards applicable at the time of producing the products.

Philips is committed to develop, produce and market products that cause no adverse health effects. Philips confirms that if its products are handled properly for their intended use, they are safe to use according to scientific evidence available today.

Philips plays an active role in the development of international EMF and safety standards, enabling Philips to anticipate further developments in standardisation for early integration in its products.

Mains fuse (UK only)

This TV is fitted with an approved moulded plug. Should it become necessary to replace the mains fuse, this must be replaced with a fuse of the same value as indicated on the plug (example 10A).

- 1 Remove fuse cover and fuse.
- 2 The replacement fuse must comply with BS 1362 and have the ASTA approval mark. If the fuse is lost, contact your dealer in order to verify the correct type.
- 3 Refit the fuse cover.

In order to maintain conformity to the EMC directive, the mains plug on this product must not be detached from the mains cord cable.

Copyright

® Kensington and Micro Saver are registered US trademarks of ACCO World corporation with issued registrations and pending applications in other countries throughout the world.



Manufactured under license from Dolby Laboratories. Dolby and the double-D symbol are trademarks of Dolby Laboratories.



Note

- Available in selected models only.



HDMI, the HDMI logo and High-Definition Multimedia Interface are trademarks or registered trademarks of HDMI Licensing LLC. All other registered and unregistered trademarks are the property of their respective owners.

2 Important

Read and understand all instructions before you use your TV. If damage is caused by failure to follow instructions, the warranty does not apply.

Safety

Risk of electric shock or fire!

- Never expose the TV to rain or water. Never place liquid containers, such as vases, near the TV. If liquids are spilt on or into the TV, disconnect the TV from the power outlet immediately. Contact Philips Consumer Care to have the TV checked before use.
- Never place the TV, remote control or batteries near naked flames or other heat sources, including direct sunlight. To prevent the spread of fire, keep candles or other flames away from the TV, remote control and batteries at all times.



- Never insert objects into the ventilation slots or other openings on the TV.
- When the TV is swivelled ensure that no strain is exerted on the power cord. Strain on the power cord can loosen connections and cause arcing.

Risk of short circuit or fire!

- Never expose the remote control or batteries to rain, water or excessive heat.
- Avoid force coming onto power plugs. Loose power plugs can cause arcing or fire.

Risk of injury or damage to the TV!

- Two people are required to lift and carry a TV that weighs more than 25 kg.
- When stand mounting the TV, use only the supplied stand. Secure the stand to the TV tightly. Place the TV on a flat, level surface that can support the combined weight of the TV and the stand.
- When wall mounting the TV, use only a wall mount that can support the weight of the TV. Secure the wall mount to a wall that can support the combined weight of the TV and wall mount. Koninklijke Philips Electronics N.V. bears no responsibility for improper wall mounting that result in accident, injury or damage.

Risk of injury to children!

Follow these precautions to prevent the TV from toppling over and causing injury to children:

- Never place the TV on a surface covered by a cloth or other material that can be pulled away.
- Ensure that no part of the TV hangs over the edge of the surface.
- Never place the TV on tall furniture (such as a bookcase) without anchoring both the furniture and TV to the wall or a suitable support.
- Educate children about the dangers of climbing on furniture to reach the TV.

Risk of overheating!

- Never install the TV in a confined space. Always leave a space of at least 4 inches or 10 cm around the TV for ventilation. Ensure curtains or other objects never cover the ventilation slots on the TV.

Risk of damage to the TV!

- Before you connect the TV to the power outlet, ensure that the power voltage matches the value printed on the back of the TV. Never connect the TV to the power outlet if the voltage is different.

Risk of injury, fire or power cord damage!

- Never place the TV or any objects on the power cord.
- To disconnect the TV power cord easily from the power outlet, ensure that you have full access to the power cord at all times.
- When you disconnect the power cord, always pull the plug, never the cable.
- Disconnect the TV from the power outlet and antenna before lightning storms. During lightning storms, never touch any part of the TV, power cord or antenna cable.

Risk of hearing damage!

- Avoid using earphones or headphones at high volumes or for prolonged periods of time.

Low temperatures

- If the TV is transported in temperatures below 5°C, unpack the TV and wait until the TV temperature matches room temperature before connecting the TV to the power outlet.

Screen care

- Avoid stationary images as much as possible. Stationary images are images that remain on-screen for extended periods of time. Examples include: on-screen menus, black bars and time displays. If you must use stationary images, reduce screen contrast and brightness to avoid screen damage.
- Unplug the TV before cleaning.
- Clean the TV and frame with a soft, damp cloth. Never use substances such as alcohol, chemicals or household cleaners on the TV.
- Risk of damage to the TV screen! Never touch, push, rub or strike the screen with any object.
- To avoid deformations and colour fading, wipe off water drops as soon as possible.

Disposal of your old product and batteries

Your product is designed and manufactured with high quality materials and components, which can be recycled and reused.



When this crossed-out wheeled bin symbol is attached to a product it means that the product is covered by the European Directive 2002/96/EC. Please inform yourself about the local separate collection system for electrical and electronic products.

Please act according to your local rules and do not dispose of your old products with your normal household waste.

Correct disposal of your old product helps to prevent potential negative consequences for the environment and human health.



Your product contains batteries covered by the European Directive 2006/66/EC, which cannot be disposed with normal household waste.

Please inform yourself about the local rules on separate collection of batteries because correct disposal helps to prevent negative consequences for the environmental and human health.

ECO-Green (Available in selected models only)



- High energy efficiency
- Low standby power
- Designed to facilitate recycling

Philips continuously focuses on lowering the environmental impact of its innovative consumer products. We aim our efforts towards environmental improvements during manufacturing, reduction of harmful substances, energy-efficient use, end-of-life instructions and product recycling. Thanks to our environmental effort, this TV has been awarded the European Ecolabel –the flower– www.ecolabel.eu

You can find detailed information on standby energy consumption, warranty policy, spare parts and recycling of this TV on the Philips website for your country at www.philips.com. This TV has features that contribute to energy-efficient use. This TV was awarded the European Ecolabel for its environmental qualities.

Energy efficiency features

- **Energy saving**
The energy saving setting of the TV combines several TV settings that result in saving energy. See the smart settings in the setup menu.
- **Low standby power consumption**
The class-leading and highly advanced power circuitry brings down the power consumption of the TV to an extremely low level, without losing out on the constant standby functionality.

Power management (Available in selected models only)

The advanced power management of this TV ensures the most efficient use of its energy. You can check how your personal TV settings, the level of brightness in current onscreen pictures and the surrounding light conditions determine the relative power consumption.

End of use

To inform yourself on the correct disposal of the TV and batteries, refer to 'Disposal of your old product and batteries' in the user manual.

3 Your TV

Congratulations on your purchase, and welcome to Philips! To fully benefit from the support that Philips offers, register your TV at www.philips.com/welcome.

This section gives you an overview of commonly used TV controls and functions.

Please read section 3 to 6 to set the basic consumer menu first, then follow the instructions in section 7 to set the Professional mode menu.

Side controls and indicators

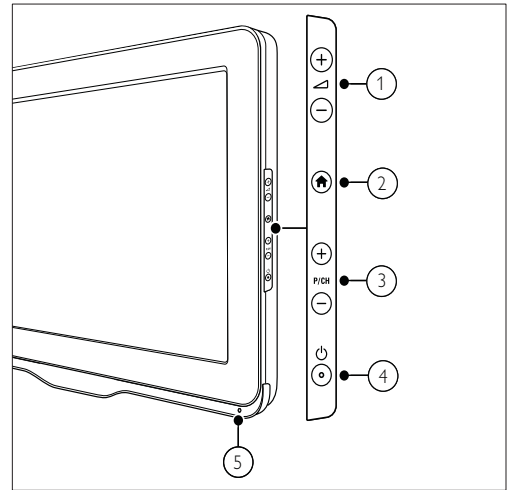

- ① \triangleleft +/-: Increases or decreases volume.
- ② 🏠 (Home): Toggles the home menu on or off.
- ③ P/CH +/-: Switches to the next or previous channel.
- ④ ⏻ (Power): Switches the product on or off. The product is not powered off completely unless it is physically unplugged.
- ⑤ Remote control sensor.

Remote control

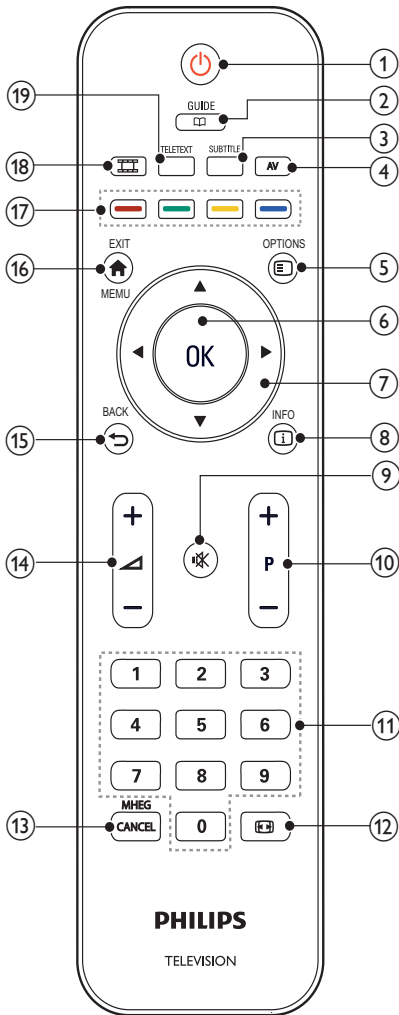

- ① **⏻ (Standby-On)**
 - Switches the TV to standby if the TV is on.
 - Switches the TV on if the TV is in standby
- ② **📖 GUIDE**
Switches between channel grid and programme list.
- ③ **SUBTITLE**
Launches the subtitle menu.
- ④ **AV**
Selects connected devices.
- ⑤ **☰ OPTIONS**
Accesses options relating to the current activity or selection. (Some features are not available when PBS is set to on.)
- ⑥ **OK**
 - Confirms an entry or selection.
 - Press to display the channel grid, when watching TV.
- ⑦ **⬆️⬆️⬅️➡️➡️ (Navigation buttons)**
Navigates through the menus.
- ⑧ **ℹ️ INFO**
Displays program information, when available. If the information spans multiple pages, press **OPTIONS** to go to the next page
- ⑨ **🔇 (MUTE)**
Mutes or restores audio output.
- ⑩ **P+/- (Programme +/-)**
Switches to the next or previous channel. When the TV menu is on, this functions as Page Up / Down.
- ⑪ **0-9 (Numeric buttons)**
Selects a channel or setting.
- ⑫ **🖼️ (Picture format)**
Launches the picture format menu.
- ⑬ **MHEG / CANCEL**
UK only: Cancels MHEG 5 function.
- ⑭ **🔊 +/- (Volume +/-)**
Increases or decreases volume.

- ⑮ **↶ BACK**
- Returns to a previous screen.
 - Returns to the previously viewed channel.
- ⑯ **🏠 MENU / EXIT**
Toggles the main menu on or off.
- ⑰ **Colour buttons**
- Selects tasks or options.
 - When Professional mode is On, press to operate Multi remote control function.
- ⑱ **🔑 (MyChoice)**
Opens MyChoice menu for entering authorized PIN code.
- ⑲ **TELETEXT**
Toggles Teletext on or off.

Remote control usage

When using the remote control, hold it close to the TV and point it at the remote control sensor. Make sure that the line-of-sight between the remote control and TV is not blocked by furniture, walls or other objects.

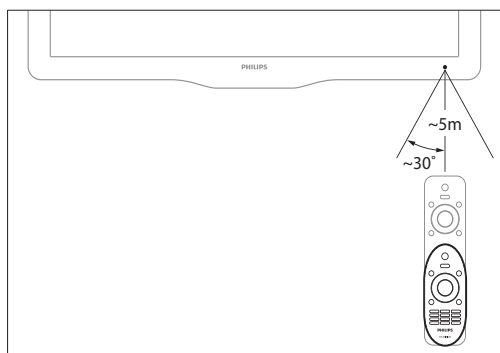

4 Use your TV

This section helps you perform basic TV operations.

Switch your TV on / off or to standby

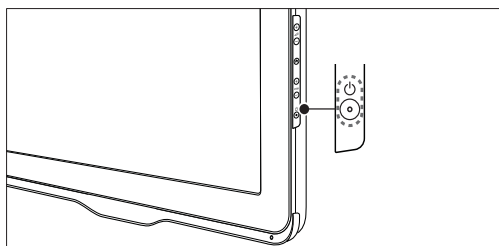

To switch on

- If the standby indicator is off, press **⏻ (Power)** at the side of the TV.
- If the standby indicator is red, press **⏻ (Standby-On)** on the remote control.

To switch to standby

- Press **⏻ (Standby-On)** on the remote control.
↳ The standby indicator switches to red.

To switch off

- Press **⏻ (Power)** at the side of the TV.
↳ The standby indicator switches off.

Tip

- Though your TV consumes very little power when in standby, energy continues to be consumed. When not in use for an extended period of time, disconnect the TV power cable from the power outlet.

Note

- If you cannot locate your remote control and want to switch on the TV from standby, press **P/CH +/-** on the side of the TV.

Switch channels

- Press **P +/-** on the remote control or **P/CH +/-** on the side of the TV.
- Enter a channel number using the **Numeric buttons**.
- Press **OK** to use the channel grid.

Note

- When you use a favourite list, you can only select those channels in the list.

Switch channels with the channel grid

The channel grid allows you to view all available channels in a grid format.

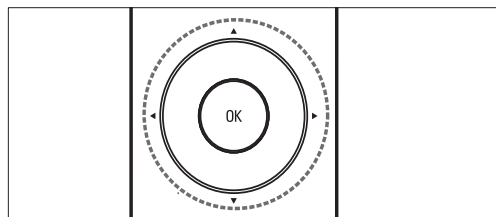

- 1 Press **OK**.
↳ The channel grid appears.
- 2 Press **▲▼◀▶** to browse the channel grid.
- 3 Press **OK** to select a channel.

Watch connected devices

Note

- Switch on the device before selecting it as a source on the TV.

Use the AV button

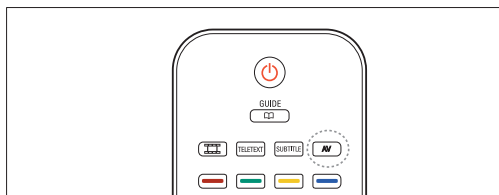

- 1 Press **AV**.
↳ The source list appears.
- 2 Press **▲▼** to select a device.
- 3 Press **OK** to confirm your choice.
↳ The TV switches to the selected device.

Adjust TV volume

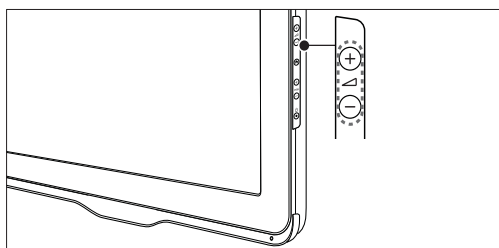
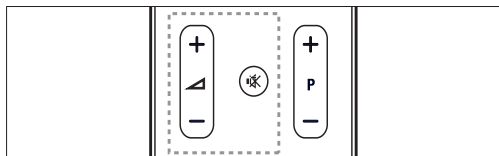

To increase or decrease volume

- Press **▲▼** +/-.

To mute or unmute sound

- Press **⊗** to mute the sound.
- Press **⊗** again to restore the sound.

Use teletext

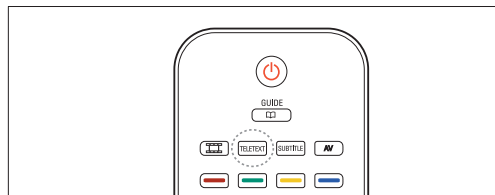

- 1 Press **TELETEXT**.
↳ The main index page appears.
- 2 Select a page as follows:
 - Press the **Numeric buttons** to enter a page number
 - Press **P +/-** to view the next or previous page
 - Press the **Colour buttons** to select a colour coded item
- 3 Press **TELETEXT** to exit teletext.

5 Use more of your TV

Access TV menus

Menus help you to install channels, change picture and sound settings and access other features.

- 1 Press **▲** MENU.
↳ The menu screen appears.

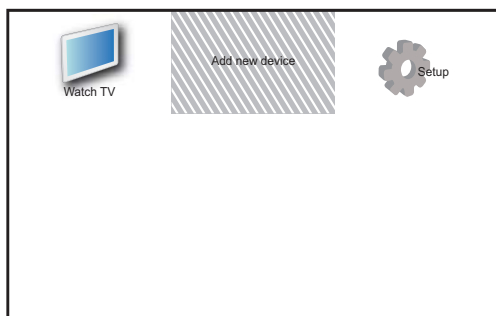

- 2 Press **▲▼◀▶** to select and navigate through one of the following menus.
 - **[Watch TV]**: Switches back to the aerial source if another source is selected.
 - **[Add new device]**: Adds new devices to the home menu.
 - **[Setup]**: Accesses menus to change picture, sound and other settings.
- 3 Press **OK** to confirm your choice.
- 4 Press **▲** MENU to exit.

Tip

- After selecting **[Add new device]**, follow the on-screen instructions to select the correct device and connector.

Use TV options menu

- 1 When watching TV, press **≡** OPTIONS.
↳ The TV options menu appears.
- 2 Press **▲▼◀▶** to select the following settings.
 - **[Universal access]**: Quickly accesses the visually impaired and hearing impaired menus (Only available when **[Universal access]** is activated, see page 17 “*Use the universal access menu*”)
 - **[Picture and sound]**: Quick accesses to picture and sound settings.
 - **[TV setup]**: Quick accesses to the TV setup menu.
 - **[TV speakers]**: Turns TV speakers on or off. (Available only when you switch on Easylink).
 - **[Mark as favourite]**: Mark current channel into favourite list.
 - **[Clock]**: Displays current time on TV screen.
 - **[Show info]**: Displays programme information.
- 3 Press **OK** to confirm your choice.

Note

- TV options menu is not available when PBS is set to on.

Rename devices from the home menu

After adding a new device to the home menu, you can rename it to your preference.

- 1 Press **▲** MENU.
- 2 Press **▲▼◀▶** to select a device to rename.
- 3 Press **≡** OPTIONS.
↳ The options menu appears.
- 4 Press **▲▼** to select **[Rename device]**, then press **OK**.
↳ A text input box appears.

- 5 Press ▲▼◀▶ to select characters.
- 6 Press **OK** to confirm each character.
- 7 Select [**Done**], then press **OK** to finish renaming devices.

Note

- The device name can be up to 16 characters long.
- Press [**Aa**] to change an uppercase letter to a lowercase letter and vice versa.

Remove devices from the home menu

If a device is no longer connected to the TV, remove it from the home menu.

- 1 Press **▲MENU**.
- 2 Press ▲▼◀▶ to select a device to remove.
- 3 Press **☰OPTIONS**.
- 4 Press ▲▼ to select [**Remove device**], then press **OK**.
- 5 Select [**Remove**], then press **OK**.
 - ↳ The selected device is removed from the home menu.

Change picture and sound settings

Change picture and sound settings to suit your preferences. You can apply pre-defined settings or change settings manually.

Note

- When watching TV or using external devices, press **☰OPTIONS** then select [**Picture and sound**] for quick access to picture and sound settings.

Use settings assistant

Use the settings assistant to guide you through the picture and sound settings.

- 1 Press **▲MENU**.
- 2 Press ▲▼◀▶ to select [**Setup**] > [**Picture**] > [**Settings assistant**].
- 3 Press **OK**.
 - ↳ The [**Settings assistant**] menu appears. Follow the on-screen instructions to choose your preferred picture settings.

Use smart picture

Use smart picture to apply pre-defined picture settings.

- 1 Press **▲MENU**.
- 2 Press ▲▼◀▶ to select [**Setup**] > [**Picture**] > [**Smart picture**].
- 3 Press ▲▼ to select one of the following settings.
 - [**Personal**]: Applies the settings set in [**Settings assistant**] menu.
 - [**Vivid**]: Applies rich and dynamic settings.
 - [**Standard**]: Adjusts picture settings to suit most environments and types of video.
 - [**Cinema**]: Applies settings for movie viewing.
 - [**Game**]: Applies settings for games.
 - [**Energy saving**]: Applies low-energy settings.
 - [**Natural**]: Applies the best picture quality.
 - [**Custom**]: Lists customised picture settings.
- 3 Press **OK** to confirm your choice.
 - ↳ The selected smart picture setting is applied.

Manually adjust picture settings

1 Press **▲** MENU.

2 Press **▲▼◀▶** to select **[Setup] > [Picture]**.

3 Press **▲▼◀▶** to select the following settings.

- **[Smart picture]**: Accesses pre-defined smart picture settings.
- **[Video contrast]**: Adjusts the intensity of video contents, keeping backlight unchanged.
- **[Contrast]**: Adjusts the intensity of backlight areas, keeping video contents unchanged.
- **[Brightness]**: Adjusts the intensity and details of dark areas.
- **[Colour]**: Adjusts colour saturation.
- **[Hue]**: Compensates for colour variations.
- **[Sharpness]**: Adjusts sharpness in the image.
- **[Noise reduction]**: Filters and reduces noise in an image.
- **[Tint]**: Adjusts the colour balance in an image.
- **[Custom tint]**: Customises tint setting. (Only available if **[Tint] > [Custom]** is selected)
- **[Digital Crystal Clear]**: Fine-tunes each pixel to match surrounding pixels. This produces a brilliant, high-definition image.
 - **[Dynamic contrast]**: Enhances contrast. A **[Medium]** setting is recommended.
 - **[Dynamic backlight]**: Adjusts brightness of the TV backlight to match lighting conditions.
 - **[MPEG artifact reduction]**: Smooths out transitions on digital pictures. You can switch this feature on or off.
 - **[Colour enhancement]**: Makes colours more vivid and improves the details in bright colours. You can switch this feature on or off.
- **[PC mode]**: Adjusts the picture when a PC is connected to the TV via HDMI or DVI.
- **[Picture format]**: Changes the picture format.
- **[Picture size]**: Adjusts the viewing area. (when set to maximum, you might see noise or a rough edge of an image.)
- **[Horizontal shift]**: Adjusts the picture horizontally for PC-VGA, DVI, HDMI or YPbPr.
- **[Vertical shift]**: Adjusts the picture vertically for PC-VGA, DVI, HDMI or YPbPr.

Change picture format

- 1 Press **[OK]**.
↳ A picture format bar appears.
- 2 Press **▲▼** to select a picture format.
↳ The selected picture format is activated.
- 3 Press **OK** to confirm your choice.

Summary of picture formats

The following picture settings can be configured.

Note

- Depending on the format of the picture source, some picture settings are not available.

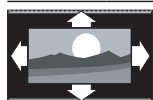

[Auto format]: (Not for PC mode.) Automatically displays the suitable picture format. If not, wide screen is applied.



[Super zoom]: (Not for HD and PC mode.) Removes the black bars on the side of 4:3 broadcasts. There is minimal distortion.



[4:3]: Shows the classic 4:3 format.



[Subtitle zoom]: Displays 4:3 pictures over the full area of the screen, with sub-titles visible. Part of the top of the picture is clipped off.



[Movie expand 14:9]: (Not for HD and PC mode.) Scales 4:3 format to 14:9.



[Movie expand 16:9]: (Not for HD and PC mode.) Scales 4:3 format to 16:9.



[Wide screen]: Scales 4:3 format to 16:9.



[Unscaled]: For HD and PC mode only, and in selected models only. Allows maximum sharpness. Some distortion may be present due to the broadcaster's systems. Set your PC resolution to wide screen mode for best results.

Use smart sound

Use smart sound to apply pre-defined sound settings.

- 1 Press **▲** MENU.
- 2 Press **▲▼◀▶** to select **[Setup] > [Sound]** > **[Smart sound]**
- 3 Press **▲▼** to select the following settings.
 - **[Custom]**: Applies the settings that were customised in the sound menu.
 - **[Standard]**: Adjusts sound settings to suit most environments and types of audio.
 - **[News]**: Applies settings for spoken audio, such as news.
 - **[Movie]**: Applies settings for movies.
- 4 Press **OK** to confirm your choice.
 - ↳ The selected smart sound setting is applied.

Manually adjust sound settings

- 1 Press **▲** MENU.
- 2 Press **▲▼◀▶** to select **[Setup] > [Sound]**.
 - ↳ The **[Sound]** menu appears.
- 3 Press **▲▼◀▶** to select the following settings.
 - **[Smart sound]**: Accesses pre-defined smart sound settings.
 - **[Bass]**: Adjusts the bass level.
 - **[Treble]**: Adjusts the treble level.
 - **[Digital audio lipsync]**: Enables or disables lipsync audio output. When this is enabled, the TV synchronises the audio and video performance. When disabled, you need to adjust the lipsync audio feature on the external device that is connected to the TV. (Only available with SPDIF connection)
 - **[Volume]**: Adjusts the volume.
 - **[Volume visually impaired]**: Adjusts the volume of visually impaired audio when your current channel supports visually impaired function. (Applies for UK only).

Note

- Selects **[Setup] > [Installation] > [Language] > [Visually impaired] > [Off]** to disable **[Volume visually impaired]**.
- **[Visually impaired] (Audio Descriptor)**: Sets the mix of visually impaired audio with regular audio. When available, visually impaired audio includes audio descriptions of on-screen action.
- **[Balance]**: Adjusts the balance of the right and left speakers.
- **[Audio language]**: Available for digital channels, when multiple languages are broadcast. Lists available audio languages.
- **[Dual I-II]**: Selects audio languages if dual sound broadcast is available.
- **[Mono/Stereo]**: Selects mono or stereo if stereo broadcast is available.
- **[TV speakers]**: Turns TV speakers on or off. (Available only when you switch on Easylink).
- **[Surround]**: Enables spatial sound.
- **[Headphone volume]**: Adjusts headphone volume.
- **[Auto volume levelling]**: Automatically reduces sudden volume changes, for example, when switching channels.
- **[Delta volume]**: Levels out volume differences between channels or connected devices. Switch to the connected device before you change the delta volume.
- **[SPDIF output]**: Selects the type of digital audio output.
 - **[PCM]**: Converts non-PCM audio to PCM audio.
 - **[Multichannel]**: Outputs audio to the home theater.

Use the universal access menu

You can activate the universal access menu during the first installation. Once enabled, you can quickly access the visually impaired and hearing impaired menus when watching TV or external devices.

Tip

- You can also enable the universal access menu by selecting **[Setup] > [Installation] > [Preferences] > [Universal access] > [On]**.

- When watching TV, press **⏻** **OPTIONS**
↳ The TV options menu appears.
- Select **[Universal access]**, then press **OK** or **▶** to enter.
- Press **◀▶** to select one of the following options and press **OK** to enter.
 - [Hearing impaired]**: Enables or disables hearing impaired subtitles.
 - [Visually impaired]**: Selects speaker, headphone or both for **[Volume visually impaired]** audio. Select **[Off]** to disable audio descriptor. (Only applicable to the UK region).
 - [Volume visually impaired]**: Adjusts the volume of visually impaired audio.

Tip

- Press the colour buttons on the remote control to enter the options.

Use advanced teletext features

Access the teletext options menu

Access the teletext features through the teletext options menu.

- Press **TELETEXT**.
↳ The teletext screen appears.
- Press **⏻** **OPTIONS**.
↳ The teletext options menu appears.
- Press **▲▼** to select one of the following options.
 - [Reveal]**: Hides or reveals hidden information on a page, such as solutions to riddles or puzzles.
 - [Cycle subpage]**: Cycles through subpages automatically if subpages are available.
 - [Language]**: Switches to a different language group to display a language correctly when it uses a different character set.
 - [Freeze page]**: Freezes the current page.
 - [Dual screen] / [Full Screen]**: Enables and disables dual screen teletext.
- Press **▲▼◀▶** to make a selection, then press **OK** to confirm.
- Press **TELETEXT** to exit the teletext options menu.

Select teletext subpages

A teletext page can hold several subpages. Subpages are displayed on a bar next to the main page number.

- Press **TELETEXT**.
↳ The teletext screen appears.
- Press **▲▼** to select a teletext page.
- Press **◀▶** to enter a subpage.

Select T.O.P. teletext broadcasts

Table Of Pages (T.O.P.) teletext broadcasts allow you to jump from one subject to another without using page numbers. T.O.P. teletext is not broadcast on all TV channels.

- 1 Press **MHEG/TELETEXT**.
↳ The teletext screen appears.
- 2 Press **INFO**.
↳ The T.O.P. overview appears.
- 3 Press **▲▼◀▶** to select a subject.
- 4 Press **OK** to view the page

Create and use list of favourite channels

You can create a list of your preferred TV channels so that you can find those channels easily.

Select a favourite list

- 1 When watching TV, press **OK** to display the channel grid.
- 2 Press **OPTIONS**.
↳ The channel options menu appears.
- 3 Press **▲▼** to select **[Select list]**, then press **OK** to enter.
↳ The channel list options appear.
- 4 Select **[Favourite]**, then press **OK**.
↳ Only channels in the favourite list appear in the channel grid.

Note

- The favourite channel grid is empty until you add channels into the favourite lists.

View all channels

You can exit a favourite list, and view all installed channels.

- 1 When watching TV, press **OK**.
↳ The channel grid appears.
- 2 Press **OPTIONS**.
↳ The channel options menu appears.
- 3 Press **▲▼** to select **[Select list]**, then press **OK** or **▶** to enter.
- 4 Select **[All]**, then press **OK**.
↳ All channels are displayed in the channel grid.

Note

- All favourite channels are marked by an asterisk when you view the channel grid.

Add a channel to a favourite list

Tip

- View all channels before adding a channel to a favourite list.

- 1 When watching TV, press **OK**.
↳ The channel grid appears.
- 2 Press **▲▼◀▶** to select a channel to add to a favourite list.
- 3 Press **OPTIONS**.
↳ The channel options menu appears.
- 4 Select **[Mark as favourite]**, then press **OK**.
↳ The channel is added to the favourite list.

Note

- All favourite channels are marked by an asterisk in the channel grid.

Remove a channel from a favourite list

- 1 When watching TV, press **OK**.
↳ The channel grid appears.
- 2 Press **▲▼◀▶** to select a channel to remove.
- 3 Press **☰** **OPTIONS**..
- 4 Select **[Unmark as favourite]**, then press **OK**.
↳ The channel is removed.

Use the Electronic Programme Guide

EPG is an on-screen guide available for digital channels. EPG allows you to:

- View a list of digital programmes being broadcast
- View upcoming programmes
- Group programmes by genre

Switch on EPG

- 1 When watching TV, press **📖** **GUIDE**.
↳ The EPG planner screen appears displaying information about the scheduled programmes.

Note

- EPG data is available only in selected countries and can take some time to load.

Tip

- Press **📖** **GUIDE** to switch between EPG and channel grid.

Use EPG

- 1 When watching TV, press **📖** **GUIDE**.
↳ The EPG planner screen appears.
- 2 Press **☰** **OPTIONS**.
↳ The program guide menu appears.
- 3 Press **▲▼◀▶** to select an option, and then press **OK** to confirm.
- 4 Press **EXIT** to exit the EPG menu.

Note

- Only the channels in the **[Preferred EPG channels]** list appear in the EPG menu.

Use the EPG options menu

Use the EPG options menu to set or clear reminders, change day and access other useful EPG options.

- 1 Press **📖** **GUIDE**.
- 2 Press **☰** **OPTIONS**.
↳ The EPG menu appears.
- 3 Press **▲▼** to select one of the following options.
 - **[Show info]**: Displays programme information.
 - **[Search by genre]**: Searches TV programmes by genre.
- 4 Press **OK** to enter or activate the option.
- 5 Press **↶** **BACK** to exit the EPG menu.

Tip

- Press **📖** **GUIDE** to switch between EPG and channel grid.

Use the TV clock

You can display a clock on the TV screen. The clock displays the current time using time data received from your TV service operator.

Set the TV clock manually

In some countries, you need to set TV clock manually.

- 1 Press **▲** MENU.
- 2 Select **[Setup]** > **[Features]** > **[Clock]**.
↳ The **[Clock]** menu appears.
- 3 Press **▲▼◀▶** to enter time.
- 4 Select **[Done]** to confirm.
- 5 Press **▲** MENU to exit.

 **Note**

- If your selected country supports digital broadcast, the clock displays the time data from your TV service operator as priority.

Display the TV clock

- 1 When watching TV, press **⏏** **OPTIONS**.
↳ The TV option menu appears.
- 2 Select **[Clock]**.
- 3 Press **OK**.

 **Note**

- To disable the clock, repeat the above procedure.

Change the clock mode

- 1 Press **▲** MENU.
- 2 Press **▲▼◀▶** to select **[Setup]** > **[Installation]** > **[Clock]** > **[Auto clock mode]**.
- 3 Press **▲▼** to select **[Automatic]** or **[Manual]**.
- 4 Press **OK** to confirm.

Change the time zone

- 1 Press **▲** MENU.
- 2 Press **▲▼◀▶** to select **[Setup]** > **[Installation]** > **[Clock]** > **[Time zone]**.
- 3 Press **▲▼** to select your time zone.
- 4 Press **OK** to confirm.

 **Note**

- This option is only available if you select **[Auto clock mode]** > **[Manual]** (in countries with clock transmission data).

Use daylight saving

- 1 Press **▲** MENU.
- 2 Press **▲▼◀▶** to select **[Setup]** > **[Installation]** > **[Clock]** > **[Daylight saving]**.
- 3 Press **OK** or **▶** to enter **[Daylight saving]**.
- 4 Press **▲▼** to select **[Standard time]** or **[Daylight saving time]**.
- 5 Press **OK** to confirm.

 **Note**

- This option is only available if you select **[Auto clock mode]** > **[Manual]**.

Use timers

You can set timers to switch the TV to standby at a specified time.

Tip

- Set the TV clock before you use timers.

Automatically switch the TV to standby (sleep timer)

Sleep timer switches the TV to standby after a pre-defined period of time.

Tip

- You can switch off your TV earlier or reset the sleep timer during the countdown.
- Press **SLEEP** on the Guest remote control to quick access the Sleep timer menu.

- 1 Press **MENU**.
- 2 Press **▲▼◀▶** to select **[Setup] > [Features] > [Sleep timer]**.
↳ The **[Sleep timer]** menu appears.
- 3 Press **◀▶** to select a value between zero and 180 minutes.
↳ The sleep timer can be set in steps of five minutes. If set to zero, the sleep timer is switched off.
- 4 Press **OK** to switch on the sleep timer.
↳ The TV switches to standby after the specified time.

Automatically switch the TV on (on timer)

You can switch the TV to a specified channel at a specified time, from standby or power-on mode.

- 1 Press **MENU**.
- 2 Press **▲▼◀▶** to select **[Setup] > [Features] > [On timer]**.
- 3 Press **▶** to enter the **[On timer]** menu.
 - **[Activate]**: Selects how often the TV is switched on.
 - **[Time]**: Sets the time to switch on the TV.
 - **[Programme no.]**: Selects the channel or the connected device.
- 4 Press **EXIT** to exit.

Tip

- Select **[On timer] > [Activate] > [Off]** to disable this feature.

Use TV locks

You can prevent your children from watching certain programmes or channels by locking the TV controls.

Set or change your PIN code

- 1 Press **MENU**.
- 2 Press **▲▼◀▶** to select **[Setup] > [Features] > [Set code] / [Change code]**.
↳ The **[Set code] / [Change code]** menu appears.
- 3 Enter your code using the **Numeric buttons**.
↳ Follow the on-screen instructions to create or change your PIN code.

Tip

- If you forget your code, enter '8888' to override any existing codes.

Lock or unlock the TV

Lock the TV to prevent access to all channels and connected devices.

- 1 Press **▲** MENU.
- 2 Press **▲▼◀▶** to select **[Setup]** > **[Features]** > **[TV lock]**.
↳ You are prompted to enter your PIN code.
- 3 Enter your code using **Numeric buttons**.
↳ The **[TV lock]** menu appears.
- 4 Press **▲▼** to select **[Lock]** or **[Unlock]**.
- 5 Press **OK** to confirm.
↳ All channels and connected devices are locked or unlocked.
- 6 Press **▲** MENU to exit.



Note

- Switch the TV off and on again for the change to take effect.
- If you select **[Lock]**, you have to enter your code every time you turn on your TV.

Lock or unlock one or more channels

- 1 When watching TV, press **OK** to display the channel grid.
- 2 Press **▲▼◀▶** to select a channel to lock or unlock.
- 3 Press **☑** **OPTIONS**.
- 4 Press **▲▼** to select **[Lock channel]** or **[Unlock channel]**.
- 5 For each selection, press **OK** to lock or unlock the channel.
↳ The first time you lock or unlock a channel, you are prompted to enter your PIN code.
- 6 Enter your code and press **OK**.
↳ If the channel is locked, a lock icon is displayed.
- 7 Repeat the process to lock or unlock more channels.



Note

- Switch the TV off and on again for the change to take effect.
- If you use **P +/-** on your remote control to switch between channels, the locked channels are skipped.
- If you access the locked channels from the channel grid, you are prompted to enter your PIN code.

Set parental ratings

Some digital broadcasters rate their programmes according to age. You can set your TV to display only programmes with age ratings higher than your child's age.

- 1 Press **▲** MENU.
- 2 Press **▲▼◀▶** to select **[Setup]** > **[Features]** > **[Parental rating]**.
↳ A code setup screen appears.
- 3 Enter your code using **Numeric buttons**.
↳ The parental rating menu appears.
- 4 Press **▲▼** to select an age rating.
- 5 Press **OK** to confirm.
- 6 Press **▲** MENU to exit.

Use subtitles

You can enable subtitles for each TV channel. Subtitles are broadcast via teletext or DVB-T digital broadcasts. With digital broadcasts, you can select a subtitle language.

Enable subtitles on analogue TV channels

- 1 Select an analogue TV channel.
- 2 Press **TELETEXT**.
- 3 Enter the three-digit page number of the subtitle page with the **Numeric buttons**.
- 4 Press **TELETEXT** to switch off teletext.
- 5 Press **SUBTITLE**.
↳ The **[Subtitle mode]** menu appears.
- 6 Select **[On]** to display subtitles always or **[On during mute]** to display subtitles only when audio is muted.
- 7 Press **OK** to enable subtitles.
- 8 Repeat this procedure to enable subtitles on each analogue channel.

Tip

- Select **[Subtitle mode]** > **[Off]** to disable subtitles.

Enable subtitles on digital TV channels

- 1 When watching digital channels, press **SUBTITLE**.
↳ The **[Subtitle mode]** menu appears.
- 2 Select **[On]** to display subtitles always or **[On during mute]** to display subtitles only when audio is muted.
- 3 Press **OK** to enable subtitles.

Select a subtitle language on digital TV channels

Note

- When you select a subtitle language on a digital TV channel as described below, the preferred subtitle language set in the installation menu is temporarily overruled.

- 1 Press **▲ MENU**.
- 2 Press **▲▼◀▶** to select **[Setup]** > **[Features]** > **[Subtitle language]**.
- 3 Press **OK** or **▶** to enter the list of available languages.
- 4 Press **▲▼** to select a subtitle language.
- 5 Press **OK** to confirm.

Tip

- You can also access the **[Subtitle language]** menu while watching TV by pressing **Ⓜ OPTIONS** > **[Subtitle language]**.

View photos and play music from a USB storage device

Caution

- Philips is not responsible if the USB storage device is not supported, nor is it responsible for damage or loss of data from the device.

Use the USB connector to view photos or listen to music stored on a USB storage device.

- 1 Turn on the TV.
- 2 Connect the USB storage device to the TV.
 - ↳ The home menu appears.
- 3 Press **▲▼◀▶** to select **[Browse USB]**.
- 4 Press **OK** to confirm.
 - ↳ The USB thumbnail browser appears.

Tip

- Press **GUIDE** to switch between thumbnail and file browsing views.

View photos

- 1 In the USB browser, press **▶** to enter the **[Picture]** folder.
- 2 Press **▲▼◀▶** to select a photo or a photo album.
- 3 Press **OK** to view a full screen image of the photo.

Tip

- When in full screen mode, press **◀▶** to move between photos.

View a slide show of your photos

- 1 When a full screen image of a photo is displayed, press **OK**.
 - ↳ A slide show begins from the selected photo.
- 2 Press the following buttons to control the slide show:
 - **OK** to pause the slide show.
 - **◀▶** to go back or move forward to the next image.
 - **EXIT** to stop the slide show.

Change slide show settings

- 1 When viewing a slide show, press **OPTION**.
 - ↳ The slide show options menu appears.
- 2 Press **▲▼** to select one of the following.
 - **[Start Slideshow] / [Stop Slideshow]**: Starts or stops a slide show.
 - **[Slideshow transitions]**: Sets the transition from one picture to the next.
 - **[Slideshow frequency]**: Sets the amount of time that a picture is shown.
 - **[Rotate image]**: Rotates a picture.
 - **[Show info]**: Displays the picture name, date, size and next picture in the slide show.
- 3 Press **OK** to confirm your setting.

Note

- **[Rotate image]** and **[Show info]** appear only when you press **OK** to pause the slideshow.

Listen to music

- 1 In the USB thumbnail browser view, select **[Music]** and press **▶** to enter.
 - Press **GUIDE** to switch between thumbnail and file browsing views.
- 2 Press **▲▼◀▶** to select a music track or album.
- 3 Press **OK** to play the selected music.

Button	Function
OK	Pause, resume play or stop playback.
◀ / ▶	Go to the previous or next music.

Music settings

When listening to music, press **OPTIONS** to access one of the following music settings.

- **[Start playback] / [Stop playback]**: Starts or stops the music.
- **[Repeat] / [Play once]**: Repeats a song. / Disables repeat play and plays a song or album once.
- **[Shuffle on] / [Shuffle off]**: Enables or disables random play of songs.
- **[Show info]**: Displays the file name.
- **[TV speakers]** (Available only when you activate Easylink): Sets the TV speakers on or off.
- **[Sound]**: Adjusts the sound setting.

Disconnect a USB storage device



Caution

- Follow this procedure to avoid damage to your USB storage device.

- 1 Press **EXIT** to exit the USB browser.
- 2 Wait for five seconds then disconnect the USB storage device.

Listen to digital radio channels

If digital broadcasting is available, digital radio channels are installed automatically during installation.

- 1 When watching TV, press **OK** to display the channel grid.
- 2 Press **OPTIONS**.
- 3 Press **▲▼** to select **[Select list] > [Radio]**.
↪ The radio channel grid appears.
- 4 Press **▲▼◀▶** to select a radio channel and press **OK** to listen.



Note

- Select **[Select list] > [All]** to exit radio channels and view all channels.

Update the TV software

Philips continuously tries to improve its products and we recommend that you update the TV software when updates are available. Check www.philips.com/support for availability.

Check the current software version

- 1 Press **▲ MENU**.
- 2 Press **▲▼◀▶** to select **[Setup] > [Software update] > [Current software inf]**.
↳ The TV displays the current software information.

Download the software

- 1 On your PC, open a web browser and go to www.philips.com/support.
- 2 Download the latest software upgrade file to your PC.
- 3 Decompress the ZIP-file.
- 4 Copy the `autorun.upg` file to the root directory of the USB device.

Update software

You can update the TV software via a USB storage device or OAD (Over the Air software Download).

Update using a USB device

Connect your USB storage device to the TV.

- 1 If the software update screen does not appear automatically, select **[Setup] > [Software update] > [Local updates] > [USB]**.
- 2 Press **OK** to update the TV software manually.
- 3 Follow the on-screen instructions to complete the update.

Note

- The TV restarts after the software update is complete.

Update using OAD

If Professional mode is **[On]**, your TV automatically receives software updates in semi-standby mode without notice on screen. The TV restarts after the software update is complete.

Change TV preferences

Use the preferences menu to customise your TV settings.

- 1 Press **▲ MENU**.
- 2 Select **[Setup] > [Installation] > [Preferences]**.
 - **[Location]**: Optimises TV settings for your location - home or shop.

Note

If **[Shop]** mode is selected:

- The **[Smart picture]** setting will be switched to **[Vivid]** automatically to display the brightest backlight on screen.
- E-sticker is applicable to display the TV selling features on screen.

- **[Volume bar]**: Displays the volume bar when you adjust the volume.
- **[Channel Information]**: Displays information about the TV channel every time you switch channels. Select **[Full]** to view channel information or **[Off]** to turn off the channel information.
- **[Universal access]**: Enables or disables the universal access menu.
- **[EasyLink]**: Enables one-touch play and one-touch standby between EasyLink-compliant devices.

- **[Pixel Plus Link]**: Overrides the settings of connected devices and uses the settings of the TV. (Available only when you activate Easylink).
- **[E-sticker]**: For shop mode only. Sets the location of the e-sticker.

- 3 Press **▲▼◀▶** to select your preference.
- 4 Press **OK**.
- 5 Press **EXIT** to exit.

Access decoder channel

You can map channels provided through a decoder or descrambler to your TV channel selection. In this way, you can select these channels by using the RC of your TV. The decoder or a descrambler must be connected to EXT1 (SCART).

Set decoder channel

Map channels from a decoder or descrambler:

- 1 Press **▲ MENU**.
- 2 Select **[Setup] > [Installation] > [Decoder]**.
- 3 Press **▶** to enter **[Decoder]** menu.
- 4 Press **▲▼** to select **[Channel]**, then press **▶** to enter.
- 5 Select one channel to map to the decoder / descrambler channel and press **OK** to confirm.
- 6 Select **[Status]**, then press **▶** to enter.
- 7 Select **[EXT 1]** (SCART) the connector used by the decoder / descrambler.
- 8 Press **OK**.
- 9 Press **EXIT** to exit.

Note

- Select **[None]** if you do not want to map to the decoder / descrambler channel.

Start a TV demo

You can use demonstrations to better understand the features of your TV. Some demos are not available on certain models. Available demos are displayed in the menu list.

Note

Before starting, make sure to turn PBS mode off for TV Demo to take effect:

- 1 Press **▲ MENU**.
- 2 Select **[Setup] > [Features] > [Demo]**.
- 3 Press **▶** to enter **[Demo]**.
- 4 Press **▲▼** to select a demo and press **OK** to view it.
- 5 Press **EXIT** to exit.

Reset the TV to factory settings

You can restore the default picture and sound settings of your TV. The channel installation settings remain the same.

- 1 Press **▲ MENU**.
- 2 Select **[Setup] > [Installation] > [Factory settings]**.
- 3 Press **▶** to enter **[Factory settings]**.
- 4 Select **[Reset]** to start resetting.
- 5 Press **OK**.
- 6 Press **EXIT** to exit.

6 Install channels

The first time you set up your TV, you are prompted to select a menu language and to install TV and digital radio channels (if available). This chapter provides instructions on how to re-install and fine tune channels.

Automatically install channels

This section describes how to search and store channels automatically.

Step 1 Select your menu language

- 1 Press **▲** MENU.
- 2 Press **▲▼◀▶** to select **[Setup] > [Installation] > [Language] > [Menu language]**.
- 3 Press **OK** or **▶** to enter **[Menu language]**.
- 4 Press **▲▼** to select a language.
- 5 Press **OK** to confirm.
- 6 Press **◀** to return to **[Installation]** menu.

Step 2 Select your country

Select the country where you are installing the TV. The available channels for the country are installed on the TV.

- 1 Press **▲** MENU.
- 2 Press **▲▼◀▶** to select **[Setup] > [Installation] > [Channel installation] > [Automatic channel search]**.
- 3 Press **OK** or **▶** to enter the menu.
↳ The country menu appears.
- 4 Press **▲▼** to select your country.
- 5 Press **OK** to confirm your choice.
↳ The channel installation guide appears on the screen.

Step 3 Install channels

Automatically installs the available analogue and digital TV channels and digital radio channels.

- 1 From the channel installation guide screen, select **[Full installation]**.
- 2 Press **OK** to confirm.
↳ The TV starts to search and store all the available channels.
- 3 When installation is complete, press **OK** to exit the installation menu.

Update the channel list

You can enable automatic update of channels when your TV is in standby mode. The channels stored in your TV are updated every morning according to the channel information in the broadcast.

- 1 Press **▲** MENU.
- 2 Press **▲▼◀▶** to select **[Setup] > [Installation] > [Channel installation] > [Standby update]**.
- 3 Select **[On]** to enable the automatic update or select **[Off]** to disable it.

Manually install channels

This section describes how to search and store analogue TV channels manually.

Step 1 Select your system

Note

- Skip this step if your system settings are correct.

- 1 Press **▲** MENU.
- 2 Press **▲▼◀▶** to select [Setup] > [Installation] > [Channel installation] > [Analogue: manual install].
↳ The [Analogue: manual install] menu appears.
- 3 Press **▲▼** to select [System], then press **▶** to enter.
- 4 Press **▲▼** to select your country or region.
- 5 Press **OK** to confirm.
- 6 Press **◀** to return to [Channel installation] menu.

Step 2 Search and store new TV channels

- 1 Press **▲** MENU.
- 2 Press **▲▼◀▶** to select [Setup] > [Installation] > [Channel installation] > [Analogue: manual install].
↳ The [Analogue: manual install] menu appears.
- 3 Press **▲▼** to select [Search], then press **▶** to enter.
- 4 Press **▲▼◀▶** to manually enter the three-digit frequency.
- 5 Press **OK** to begin search.
↳ If a channel is unavailable at the selected frequency, press **OK** to search for the next available channel.

- 6 Press **◀** when the new channel is found.
- 7 Press **▲▼** to select [Store as new channel] to store the new channel under a new channel number.
- 8 Press **OK** to enter [Store as new channel], then press **OK**.
- 9 Press **◀** to return to the [Channel installation] menu.

Step 3 Fine-tune analogue channels

- 1 Press **▲** MENU.
- 2 Press **▲▼◀▶** to select [Setup] > [Installation] > [Channel installation] > [Analogue: manual install].
↳ The [Analogue: manual install] menu appears.
- 3 Press **▲▼** to select [Fine tune], then press **▶** to enter.
- 4 Press **▲▼** to adjust frequency.
- 5 Press **OK** to confirm.
- 6 Press **▲▼** to select [Store current channel] to store the channel number.
- 7 Press **▶** to enter [Store current channel], then press **OK**.
- 8 Press **◀** to return to the [Channel installation] menu.

Rename channels

You can rename channels. The name appears when you select the channel.

- 1 When watching TV, press **OK** to display the channel grid.
- 2 Select the channel to rename.
- 3 Press **⏏** **OPTIONS**.
↳ The channel options menu appears.
- 4 Press **▲▼** to select **[Rename channel]**, then press **OK**.
↳ A text input box appears.
- 5 Press **▲▼◀▶** to select characters.
- 6 Press **OK** to confirm each character.
- 7 Select **[Done]**, then press **OK** to finish renaming channels.



Tip

- Press **[Aa]** to change an uppercase letter to a lowercase letter and vice versa.

Rearrange channels

After you install channels, you can rearrange the order in which they appear.

- 1 When watching TV, press **OK** to display the channel grid.
- 2 Press **⏏** **OPTIONS**.
↳ The channel options menu appears.
- 3 Press **▲▼** to select **[Reorder]**, then press **OK**.
- 4 Select the channel to rearrange, then press **OK**.
↳ The selected channel is highlighted.
- 5 Press **▲▼◀▶** to move the highlighted channel to the desired location, then press **OK**.

- 6 Press **⏏** **OPTIONS**.
↳ **[Done reordering]** appears on the screen.
- 7 Press **OK** to confirm.
- 8 Press **EXIT** to exit the channel grid.

Test digital reception

You can check the quality and signal strength of digital channels. This allows you to reposition and test your antenna or satellite dish.

- 1 Press **⬆** **MENU**.
- 2 Press **▲▼◀▶** to select **[Setup]** > **[Installation]** > **[Channel installation]** > **[Manual channel search]**.
- 3 Press **▶** to enter the menu.
- 4 Press **▲▼◀▶** to enter the frequency of the channel you want to test.
- 5 Press **OK** to confirm the frequency, then press **OK** again to confirm **[Search]**.
- 6 When complete, select **[Store]** to store the frequency.



Note

- If the signal quality and strength is poor, reposition the aerial or satellite dish and retest.
- If you still have problems with the reception of your digital broadcast, contact a specialised installer.

7 Professional mode instruction

Introduction

Included in this TV is a special functional mode that allows the TV to be configured for commercial application. This feature is called Professional mode.

This section has been designed to help install and operate this TV in Professional mode. Before reading this section, please read section 3 to 6 to set the basic functionality of this TV.

Benefits of Professional mode

This TV is specially designed to operate in Professional Mode. Professional Mode offers the following benefits:

- Access to the **[Consumer Menu]** can be blocked. This prevents users (e.g. guests) from deleting or changing channel settings and / or modifying picture and sound settings. This ensures that TVs are always set up correctly.
- A switch-on volume and channel can be selected. After switching on, the TV will always start on the specified volume level and channel.
- The maximum volume level of the TV can be limited in order to prevent disturbance to other guest.
- Channels can be blanked (Video only).
- The TV local buttons **VOLUME +/-**, **P/CH+/-** and **🏠 (Home)** can be locked.
- Screen information can be suppressed.

Professional Setup Remote control (2573 optional)

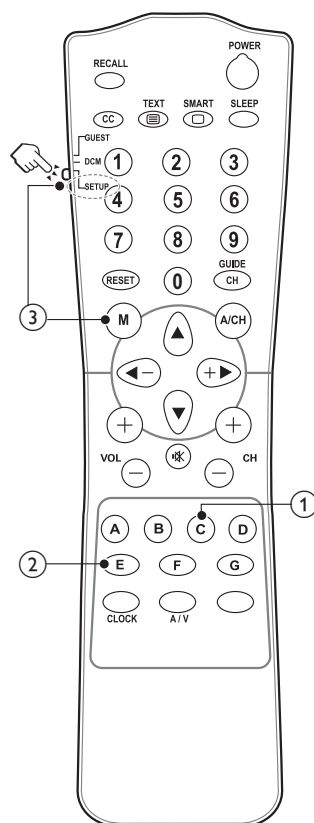

- ① **C button (OPTIONS)**
Accesses options relating to the current activity or selection. (Equals to the function of **☰ OPTIONS** on Guest remote control).
- ② **E button (OK)**
Confirms an entry or selection.
- ③ **(Enters Professional setup menu)**
 - Selects **SETUP** mode first.
 - Press **M button** to enter the Professional setup menu.

Note

- **SETUP** mode should be selected for hotel installer.

Activating the Professional mode setup menu

- 1 Switch on the TV and select a TV channel.
- 2 Press the following buttons to access Professional mode setup menu:
 - **[3, 1, 9, 7, 5, 3+ MUTE]** on Guest remote control.
 - **M button** on Professional setup remote control. (When **SETUP** mode is selected on the Professional setup remote control.)
- 3 Press **▲▼◀▶** on the remote control to select and change any of the settings.
- 4 When done, select **[Store] > [Confirm]** to save the changes.
Press **EXIT** to exit without saving.
- 5 For Professional mode settings to take effect, you must restart the TV mains power.

Professional mode options

This paragraph describes the functionality of each item in the Professional mode setup menu.

Layer 1	Layer 2	Layer 3
PBS settings	PBS mode	Off / On
	Consumer setup	Action
	USB to TV	Action
	TV to USB	Action
	Reset	Action
Switch on setting	Max volume	0 ~ Max
	Switch on picture format	Auto format / Super zoom / 4:3 / Subtitle zoom / Movie expand 14:9 / Movie expand 16:9 / Wide screen / Unscaled
	Power on	On / Standby / Last status
	Smart power	Off / Low / Medium / High
Switch on vol	Last status	Off / On
	User defined	0 ~ 60
Switch on channel	Last status	Off / On
	User defined	[List of channels]
Welcome message	Display message	Off / On
	Line 1	Edit
	Line 2	Edit
	Clear	Action
	Message Time-out	20 sec / 25 sec / 30 sec
Control settings	Local KB lock	Off / On / All
	RC lock	Off / On
	OSD display	Off / On
	High security	Off / On
	Auto scart	Off / On / Power on scart
	HDMI-CEC in	Off / On
	USB break in	Off / On
	Enable teletext	Off / On
	Enable MHEG	Off / On
	Enable EPG	Off / On
	Enable subtitle	Off / On
	Enable USB	Off / On
Blue mute	Off / On	

Layer 1	Layer 2	Layer 3
Control settings	Digit timeout	0.5 ~ 9.9 seconds
	Selectable AV	List of selectable external sources.
Speaker settings	TV speaker enable	On / Off
	Independent main speaker mute	On / Off
	Default main speaker volume	0 ~ 60
Installation	Blank channel	All available channels.
	Disable auto updating	Software / Channels / Both / Off
	Skip scrambled signals	Off / On
	Multi remote control	Blue / Green / Yellow / Red / Off
MyChoice setup	MyChoice	Off / On
	R0	Pay TV channel list..
	R1	All available channels.
Store	Action	Confirm / Cancel

PBS settings

[PBS mode]

Enables / disables the Professional mode.

- **[On]:** All settings in the Professional mode Setup menu are in effect.
- **[Off]:** The TV operates as a normal (consumer) TV.

[Consumer setup]

A shortcut to enter the full TV menu. This allows the installers to do all the TV setup settings.

[USB to TV]

Loads the TV configuration data (including the video, audio, channel Table, and Professional mode settings) from a USB device to the TV set.

[TV to USB]

Loads the TV configuration data (including the video, audio, channel Table, and Professional mode settings) from the TV set to a USB device.

[Reset]

Selects **[Yes]** to reset all settings in Professional mode to factory default.

Switch on setting

[Max volume]

This option specifies the maximum allowable volume level of the TV.

[Switch on picture format]

Sets available picture format when the TV is switched on.



Note

- If the picture format is not supported with the activated source, **[Auto format]** detection is applied.

[Power on]

The power on function allows the TV to enter a specific mode (**[On]**, **[Standby]**, or **[Last status]**) of operation after the mains power is activated.

- **[On]:** When set, the TV will always turn on after the mains power is activated.
- **[Standby]:** When set, the TV will always turn to standby after the mains power is activated.
- **[Last status]:** When set, the TV will always turn to the last status (either On or Standby) whenever the mains power is activated.

[Smart power]

Adjusts the picture backlight to achieve the following power saving mode.

- **[Off]:** Smart power is disabled. (**[Custom]** mode is applied).
- **[Low]:** The picture backlight is at low power saving mode. (**[Cinema]** mode is applied).
- **[Medium]:** The picture backlight is at medium power saving mode. (**[Standard]** mode is applied).
- **[High]:** The picture backlight is at high power savings mode. (**[Energy saving]** is applied).

Switch on vol

When the guest switches the TV on, it will play at the specified volume level.

- **[Last status]:** If **[On]** is selected, the TV will be automatically switched to the last volume status whenever the mains power is turned on. (The volume level can not exceed the **[Maximum volume]** level).
- **[User defined]:** (Only appears when you select **[Last status] > [Off].**) The guest can adjust his/her preferred switch on volume level.

Switch on channel

When the guest switches the TV on, it will play at the specified channel.

- **[Last status]:** If **[On]** is selected, the TV will be automatically switched to the last channel status whenever the mains power is turned on.
- **[User defined]:** (Only appears when you select **[Last status] > [Off].**) The guest can choose his / her preferred switch on channel.

Welcome message

The Welcome message function allows the TV to show a customized greeting to the hotel guest whenever the TV is switched on. This helps to personalize the hotel experience for guests. The Welcome message can consist of 2 lines of text, with each line containing a maximum of 20 alphanumeric characters. Use **▲ ▼ ◀ ▶** on the remote control to compose the Welcome message.

Note

- Welcome message is always disabled if you select **[Control settings] > [OSD display] > [Off.]**

- **[Display message]:** Selects **[On]** to activate the welcome message.
- **[Line 1]:** Sets the characters of the first line message.
- **[Line 2]:** Sets the characters of the second line message.
- **[Clear]:** Clear the settings in Line 1 and Line 2.
- **[Message Time-out]:** Sets the period of time to display the welcome message on the screen when TV is turned on from standby / Off.

Control settings

[Local KB lock]

- **[Off]:** The TV local buttons will function normally.
- **[On]:** The TV local buttons except **POWER** are locked.
- **[All]:** All TV local buttons are locked, including **POWER** button.

[RC lock]

Disables the operation of the Guest remote control.

- **[Off]:** All buttons on Guest remote control will function normally.
- **[On]:** All buttons on the Guest remote control are disabled. (It is still possible to enter the Professional setup menu by pressing **[3, 1, 9, 7, 5, 3 + MUTE]**).

[OSD display]

Sets this function to show or hide screen information.

- **[Off]:** Screen information is suppressed.
- **[On]:** Normal screen information is displayed.

[High security]

- **[Off]:** Professional mode setup menu can be accessed by both Guest remote control (Press **[3, 1, 9, 7, 5, 3 + MUTE]**) and the Professional setup remote control (Press **M** button)
- **[On]:** Professional mode setup menu can only be accessed by the Professional setup remote control.

[Auto scart]

Enables auto scart switching or break-in Professional mode.

- **[Off]:** Disables auto scart switching or break-in Professional mode.
- **[On]:** Enables auto scart switching or break-in Professional mode.
- **[Power on scart]:** Sets scart source as power on / off button. When the connected scart source is turned on / off, the TV enters to on / standby mode simultaneously.

[HDMI-CEC in]

HDMI-CEC (Philips EasyLink) enables one-touch play and one touch standby between HDMI-CEC compliant devices.



Note

- Before activating HDMI-CEC in function, make sure the HDMI-CEC compliant devices are turned to on.
- Selects **[EasyLink] > [On]** first before enabling **[HDMI-CEC in]** in Professional mode.
- Refer to page 44 "*Use Philips EasyLink*" for more details about HDMI-CEC function.

- **[Off]:** Disables HDMI-CEC feature in Professional mode.
- **[On]:** Enables HDMI-CEC feature in Professional mode.

[USB break-in]

Enables or disables USB break-in feature in Professional mode.

- **[Off]:** When USB is plugged in, the **[Multimedia]** menu will not appear automatically, but users can access **[Multimedia]** menu from the **[Consumer setup]** menu.
- **[On]:** When USB is plugged in, the **[Multimedia]** menu appears automatically.

[Enable teletext]

- **[Off]:** Disables teletext in Professional mode.
- **[On]:** Enables teletext in Professional mode.

[Enable MHEG] (For UK only)

- **[Off]:** Disables MHEG in Professional mode.
- **[On]:** Enables MHEG in Professional mode.

[Enable EPG]

- **[Off]:** Disables EPG in Professional mode.
- **[On]:** Enables EPG in Professional mode.

[Enable subtitle]

- **[Off]:** Closes subtitles in Professional mode.
- **[On]:** Displays subtitles in Professional mode.

[Enable USB]

- **[Off]:** Disables USB multimedia function in Professional mode. (Software update functions normally).
- **[On]:** USB multimedia functions normally in Professional mode.



Note

- Refer to page 21 “*View photos and play music from a USB storage device*” for more details about USB multimedia function.

[Blue mute]

Sets the background colour when there is no signal on TV.

- **[Off]:** The background colour is set to black.
- **[On]:** The background color is set to blue.

[Digit timeout]

Defines the time interval between numeric buttons when users press digits on the remote control. The duration is from 0.5 to 9.9 seconds. When digit is pressed, the timer refreshes.

[Selectable AV]

Allows the installer to define which external sources to be displayed on the source list when pressing **AV** button on the Guest remote control.

Only the sources marked with **[X]** appear in the source list.

Speaker settings

[TV speaker enable]

- **[Off]:** Disables the TV speaker. The headphone volume functions normally.
- **[On]:** The TV speaker is enabled. (Default setting).

[Independent main speaker mute]

This option only appears when you select **[TV speaker enable] > [On]**.

- **[Off]:** Press (MUTE) or on the Guest remote control will affect both the TV speaker and the headphone volume (Default setting)
- **[On]:** Press (MUTE) on the Guest remote control will affect the TV speaker volume only. The headphone volume functions normally.



Note

- If the TV speaker is muted independently, press on the Guest remote control will only affect the headphone volume.

[Default main speaker volume]

Only appears when you select **[Independent main speaker mute] > [On]**. Users can set the TV speaker and headphone volume to a certain level as the default setting. This option can avoid sudden high-volume when TV speaker is turned on again from independently mute.

Installation

[Blank channel]

The Blank channel function disables the display of video on the TV, but does not affect the audio output. This function can be used for audio applications (example: music-only channels, and so on) which do not necessarily require the display of video.

- 1 Enters the **[Blank channel]**, the list of all channels appear.
- 2 Selects one or more channels and press **OK** to mark.
- 3 The channels marked with **[X]** will not display video on the TV.

[Disable auto updating]

- **[Software]:** Disables automatic TV software update via OAD (On the air software download).
- **[Channel]:** Disables automatic channel installation when new channels are detected.
- **[Both]:** Disables automatic update of the TV software and the channel installation.
- **[Off]:** Enables automatic update of the TV software and the channel installation.

[Skip scrambled signals]

- **[Off]:** Allows scrambled channels in the channel list.
- **[On]:** Skips the scrambled channels in the channel list.

[Multi remote control]

Guest remote control supports up to four televisions operating in one room without interference from each other's remote controls. Each TV and the Guest remote control can be set to match each others.

- 1 Enters **[Multi remote control]** and designate one colour (**Blue / Green / Yellow / Red**) to the TV. Selects **[Off]** to disable **[Multi remote control]** function.
- 2 Sets the Guest remote control to the corresponding colour by pressing **▲ MENU** and one of the **colour button** simultaneously for more than 4 seconds.
- 3 The Guest remote control can operate the TV with the corresponding colour.



Note

- **EXAMPLE:** Press **▲ MENU** and **Red button** simultaneously on the Guest remote control for more than 4 seconds to operate the TV with **[Red]** colour selected in **[Multi remote control]** menu.
- Guest remote control will be set to default **Blue colour** after replacing batteries.

[MyChoice]

- **[Off]:** Disables MyChoice function.
- **[On]:** **[MyChoice]** appears in the Guest home menu. Press **▲ MENU > [MyChoice]** and enters authorized PIN code to watch MyChoice channels.

MyChoice setup

This function allows you to customized MyChoice channel list.

- 1 Enters **[MyChoice setup]** in the Professional setup menu.
- 2 Sets MyChoice channels from the following TV channel lists:
 - **[R0]**: List of MyChoice channels and normal channels. Channels marked with **[X]** can only be watched after pressing authorized PIN code.
 - **[R1]**: List of all available channels. Unmark MyChoice channels to prevent users from watching full MyChoice channels via Guest remote control.

Note

- All non-MyChoice channels are listed in **[R1]**.
- Before pressing authorized PIN code, **[R1]** is the default channel list everytime you start the TV mains power.

Store settings

In the Professional setup menu, select **[Store]** > **[Confirm]** to save the changes.

Note

- Restarts the TV mains power for the changes to take effect.

8 Connect devices

This section describes how to connect devices with different connectors. Examples are provided in the Quick Start.

Note

- You can use different types of connectors to connect a device to your TV.

Back connector

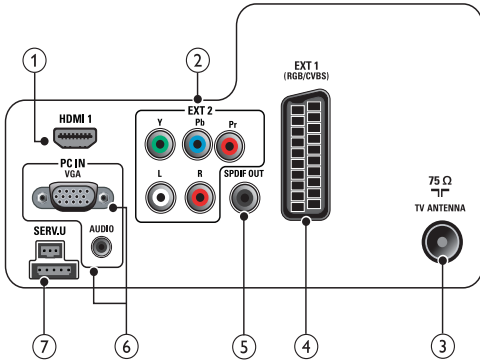

① HDMI 1

Digital audio and video input from high-definition digital devices such as Blu-ray players.

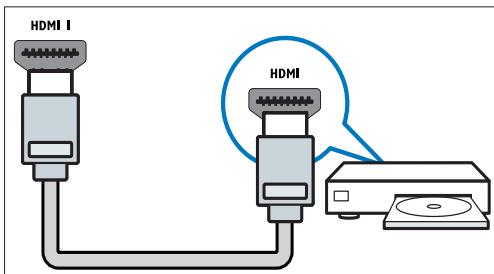

Connections via DVI or VGA require an additional audio cable.

② EXT 2 (Y Pb Pr and AUDIO L/R)

Analogue audio and video input from analogue or digital devices such as DVD players or game consoles.

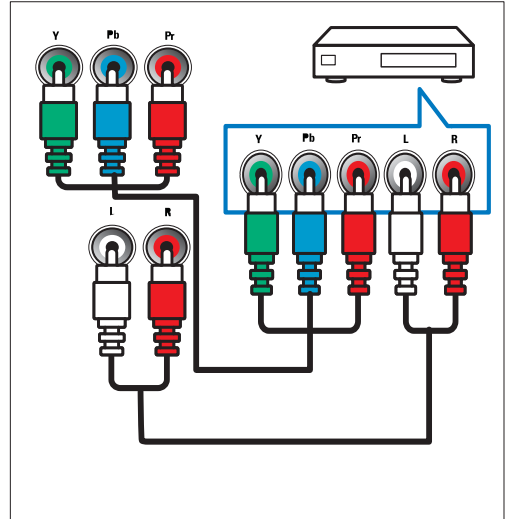

③ TV ANTENNA

Signal input from an antenna, cable or satellite.

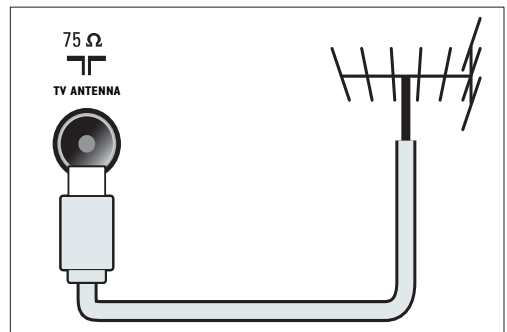

④ EXT 1 (CVBS and RGB)

Analogue audio and video input from analogue or digital devices such as DVD players or game consoles.

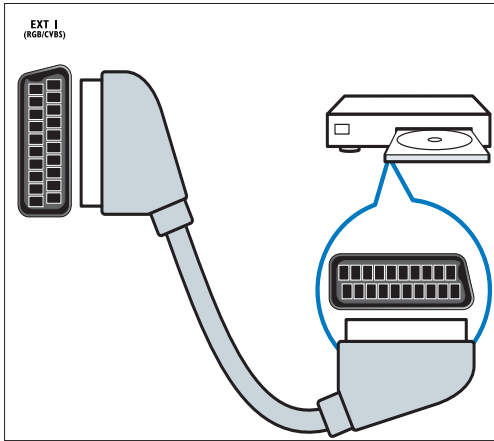

⑤ SPDIF OUT

Digital audio output to home theatres and other digital audio systems.

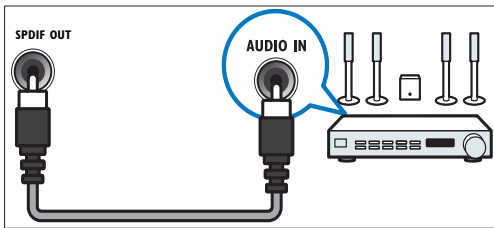

⑥ PC IN (VGA and AUDIO)

Audio and video input from a computer.

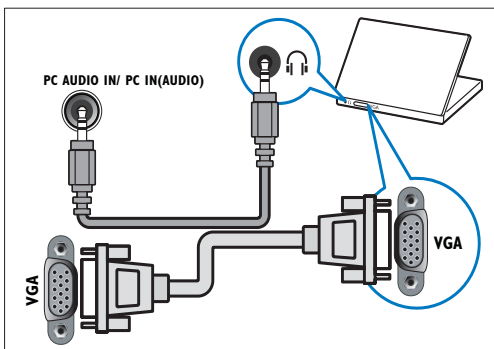

⑦ SERV. U

For technical application only.

Side connector

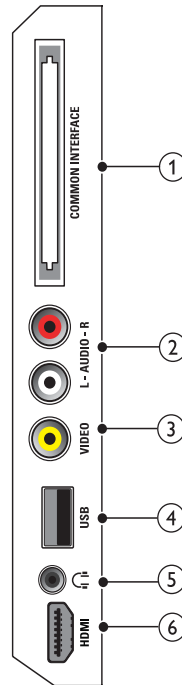

① COMMON INTERFACE

Slot for a Conditional Access Module (CAM).

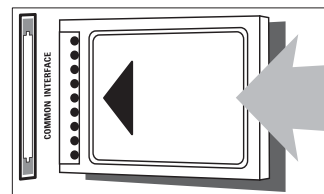

② AUDIO L/R

Audio input from analogue devices connected to **VIDEO**.

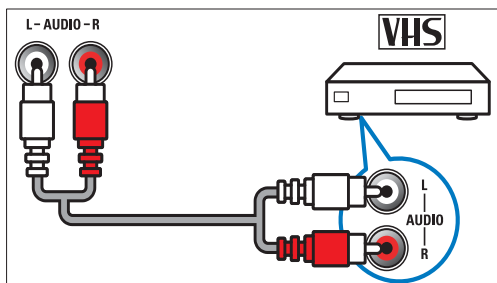

③ VIDEO

Composite video input from analogue devices such as VCRs.

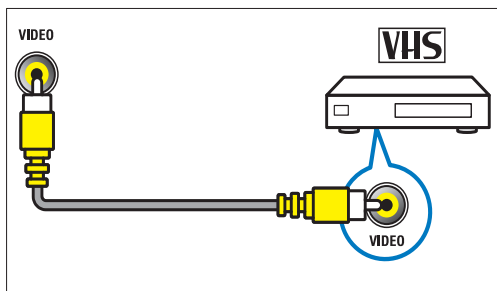

④ USB

Data input from USB storage devices.

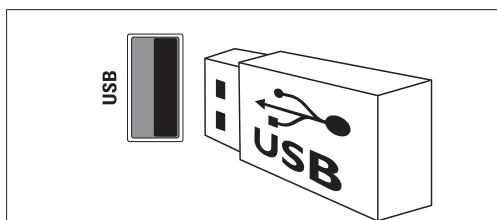

⑤ 🎧 (Headphone)

Stereo audio output to headphones or earphones.

⑥ HDMI (Available only in 26 inch TV)

Digital audio and video input from high-definition digital devices such as Blu-ray players.

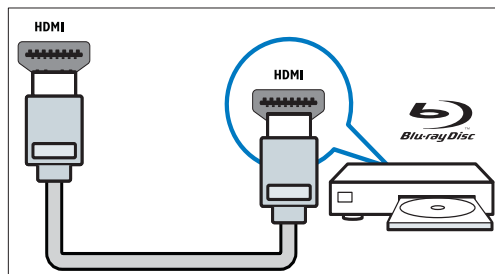

Connect a computer

Before you connect a computer to the TV

- Set the screen refresh rate on your computer to 60Hz.
- Select a supported screen resolution on your computer.

Connect a computer with one of the following connectors:

Note

- Connections via DVI or VGA require an additional audio cable.

- HDMI cable

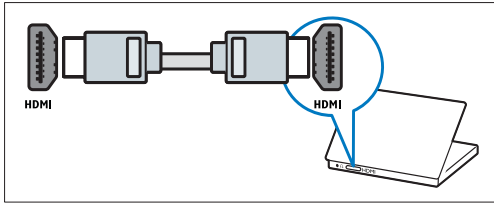

- DVI-HDMI cable

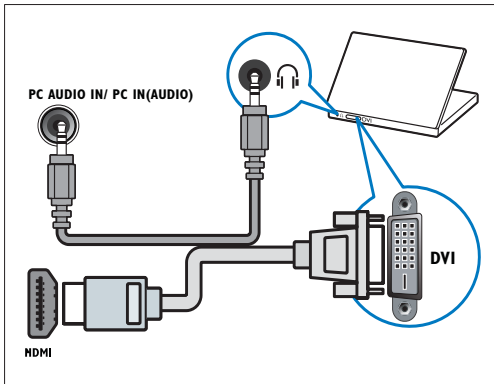

- HDMI cable and HDMI-DVI adaptor

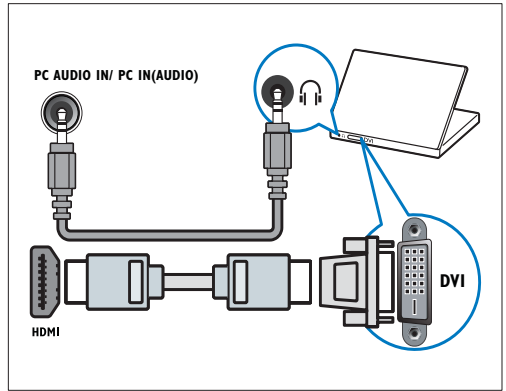

- VGA cable

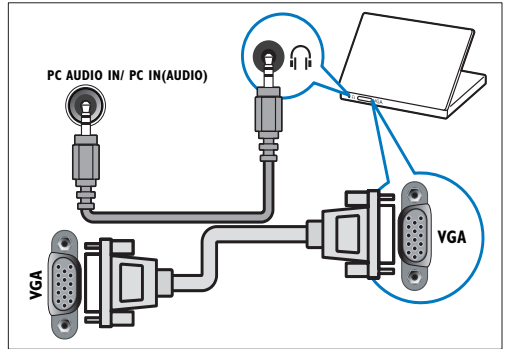

Use a Conditional Access Module

A Conditional Access Module (CAM) is provided by digital TV service operators to decode digital TV channels.

Note

- Refer to the documentation from your service operator on how to insert a smart card into the Conditional Access Module.

Insert and activate a CAM

Caution

- Be sure to follow the instructions described below. Wrong insertion of a CAM may damage both the CAM and your TV.

- 1 Switch off the TV and disconnect it from the power outlet.
- 2 Following the directions printed on the CAM, gently insert the CAM into the **COMMON INTERFACE** at the side of the TV.

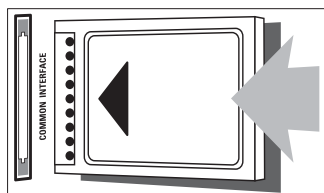

- 3 Push the CAM in as far as it will go.
- 4 Reconnect the TV to the power outlet.
- 5 Turn on the TV and wait for the CAM to be activated. This may take several minutes. Do not remove the CAM from the slot when in use — removing the CAM will deactivate digital services.

Access CAM services

- 1 After inserting and activating the CAM, press **▲ MENU**.
- 2 Press **▲▼◀▶** to select **[Setup] > [Features] > [Common interface]**.
 - ↳ Applications provided by the digital TV service operator appear on the screen.

Note

- This menu option is available only if the CAM is inserted and activated correctly.

Use Philips EasyLink

Your TV supports Philips EasyLink, which uses the HDMI CEC (Consumer Electronics Control) protocol. EasyLink-compliant devices that are connected through HDMI connectors can be controlled by a single remote control.

Note

- The EasyLink-compliant device must be switched on and selected as the source.
- Philips does not guarantee 100% interoperability with all HDMI CEC devices.

EasyLink features

One-touch play

When you connect your TV to devices that support one-touch play, you can control your TV and the devices with one remote control.

One-touch standby

When you connect your TV to devices that support standby, you can use your TV remote control to put your TV and all connected HDMI devices in standby mode.

System audio control

When you connect your TV to HDMI CEC compliant devices, your TV can switch automatically to play audio from the connected device.





To use one-touch audio, you must map the audio input from the connected device to your TV.

You can use the remote control from the connected device to adjust the volume.

Enable or disable EasyLink

Note

- Do not enable Philips EasyLink if you do not intend to use it.

- 1 Press  MENU.
- 2 Press    to select [Setup] > [Installation] > [Preferences] > [EasyLink].
- 3 Select [On] or [Off].

Use one-touch play







- 1 After enabling EasyLink, press play on your device.
 - ↳ The TV automatically switches to the correct source.

Use one-touch standby

- 1 Press  (Standby-On) on the TV's or device's remote control.
 - ↳ The TV and all connected HDMI devices switch to standby.

Set TV speakers to EasyLink mode

When you play content from an EasyLink compliant home theater, the TV speakers are automatically muted.

- 1 Enable one-touch play and one-touch standby between your Easylink compliant devices by following the instructions in the previous section.
- 2 Press  MENU.
- 3 Press    to select [Setup] > [Sound] > [TV speakers] > [Auto EasyLink].
 - ↳ The TV speakers are turned off automatically when content from an Easylink compliant system is detected.
- 4 Press    to select [Setup] > [Sound] > [TV speakers] > [On] to disable system audio control and enable the TV speakers.

Note

- To mute the TV speakers, select [TV speakers] > [Off].

Use a Kensington lock

There is a Kensington security slot at the back of the TV. Prevent theft by looping a Kensington lock between the slot and a permanent object, such as a heavy table.

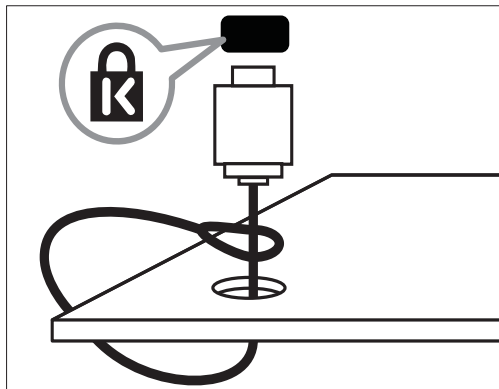

9 Product information

Product information is subject to change without notice. For detailed product information, go to www.philips.com/support.

Supported display resolutions

Computer formats

- Resolution - refresh rate:
 - 640 × 480 - 60Hz
 - 800 × 600 - 60Hz
 - 1024 × 768 - 60Hz
 - 1280 × 720 - 60Hz
 - 1280 × 1024 - 60 Hz
 - 1360 × 768 - 60Hz

Video formats

- Resolution - refresh rate:
 - 480i - 60Hz
 - 480p - 60Hz
 - 576i - 50Hz
 - 576p - 50Hz
 - 720p - 50Hz, 60Hz
 - 1080i - 50Hz, 60Hz
 - 1080p - 24Hz, 25Hz, 30Hz, 50Hz, 60Hz.

Multimedia

- Supported storage device: USB (Only FAT or FAT 32 USB storage devices are supported)
- Supported multimedia file formats:
 - Images: JPEG
 - Audio: MP3



Note

- Multimedia file names must not exceed 128 characters.

Tuner / Reception / Transmission

- Aerial input: 75ohm coaxial (IEC75)
- DVB: DVB Terrestrial, DVB-T MPEG4
- TV system: DVB COFDM 2K/8K; PAL I, B/G, D/K; SECAM B/G, D/K, L/L'
- Video playback: NTSC, SECAM, PAL
- Tuner Bands: Hyperband, S-channel, UHF, VHF

Remote control

- Type: 22AV1104B/10
- Batteries: 2 × AAA (LR03 type)

Power

- Mains power: 220-240V, 50~60Hz
- Standby power: < 0.3 W
- Ambient temperature: 5 to 40 degrees Celsius

Supported TV mounts

To mount the TV, purchase a Philips TV mount. To prevent damage to cables and connectors, be sure to leave a clearance of at least 2.2 inches or 5.5cm from the back of the TV.



Warning

- Follow all instructions provided with the TV mount. Koninklijke Philips Electronics N.V. bears no responsibility for improper TV mounting that results in accident, injury or damage.

TV screen size (inches)	Required pitch (mm)	Required mounting bolts ($\leq 10\text{mm}$)
19	75 x 75	4 x M4
22	75 x 75	4 x M4
26	75 x 75	4 x M4

Product specification

Design and specifications are subject to change without notice.

19HFL3232D

- Without TV stand
 - Dimension (WxHxD): 455 x 303.7 x 56 (mm)
 - Weight: 3.16 kg
- With TV stand
 - Dimension (WxHxD): 455 x 328.7 x 137.9 (mm)
 - Weight: 3.32 kg

22HFL3232D

- Without TV stand
 - Dimension (WxHxD): 526.02 x 343.5 x 55.79 (mm)
 - Weight: 4.0 kg
- With TV stand
 - Dimension (WxHxD): 526.02 x 369.5 x 148.96 (mm)
 - Weight: 4.2 kg

26HFL3232D

- Without TV stand
 - Dimension (WxHxD): 637.4 x 410.8 x 63 (mm)
 - Weight: 5.21 kg
- With TV stand
 - Dimension (WxHxD): 637.41 x 447.25 x 170 (mm)
 - Weight: 5.5 kg

10 Troubleshooting

This section describes commonly encountered issues and accompanying solutions.

General TV issues

The TV does not switch on:

- Disconnect the power cable from the power outlet. Wait for one minute then reconnect it.
- Check that the power cable is securely connected.

The remote control is not working properly:

- Check that the remote control batteries are correctly inserted according to the +/- orientation.
- Replace the remote control batteries if they are flat or weak.
- Clean the remote control and TV sensor lens.

The standby light on the TV blinks red:

- Disconnect the power cable from the power outlet. Wait until the TV cools down before reconnecting the power cable. If the blinking reoccurs, contact Philips Consumer Care.

You forgot the code to unlock the TV lock feature

- Enter '8888'.

The TV menu is in the wrong language.

- Change the TV menu to your preferred language.

When turning the TV on / off / to standby, you hear a creaking sound from the TV chassis:

- No action is required. The creaking sound is normal expansion and contraction of the TV as it cools down and warms up. This does not impact performance.

TV channel issues

Previously installed channels do not appear in the channel list:

- Check that the correct channel list is selected.

No digital channels were found during the installation:

- Check that the TV supports DVB-T, DVB-T Lite or DVB-C in your country.

Some channels are not automatically installed on my TV:

- During installation, make sure that you select the country where you are installing the TV.

Picture issues

The TV is on, but there is no picture:

- Check that the antenna is properly connected to the TV.s
- Check that the correct device is selected as the TV source.

There is sound but no picture:

- Check that the picture settings are correctly set.

There is poor TV reception from an antenna connection:

- Check that the antenna is properly connected to the TV.
- Loudspeakers, unearthed audio devices, neon lights, high buildings and other large objects can influence reception quality. If possible, try to improve the reception quality by changing the antenna direction or moving devices away from the TV.
- If reception on only one channel is poor, fine tune this channel.

There is poor picture quality from connected devices:

- Check that the devices are connected properly.
- Check that the picture settings are correctly set.

The TV did not save your picture settings:

- Check that the TV location is set to the home setting. This mode offers you the flexibility to change and save settings.

The picture does not fit the screen; it is too big or too small:

- Try using a different picture format.

The picture position is incorrect:

- Picture signals from some devices may not fit the screen correctly. Check the signal output of the device.

Cannot remove 'e-sticker' banner displayed on the TV.

- To remove the logos and images, set the location of your TV to home.

1. Press **HOME** MENU.

2. Select **[Setup] > [Installation] > [Preferences] > [Location]**.

3. Select **[Home]** and press **OK**.

Sound issues

There is a picture but sound quality is poor:



Note

- If no audio signal is detected, the TV automatically switches the audio output off — this does not indicate malfunction.

- Check that all cables are properly connected.
- Check that the volume is not set to 0.
- Check that the sound is not muted.

There is a picture but the sound quality is poor:

- Check that the sound settings are correctly set.

There is a picture but sound comes from one speaker only:

- Verify that sound balance is set to the centre.

HDMI connection issues

There are problems with HDMI devices:

- Note that HDCP (High-bandwidth Digital Content Protection) support can delay the time taken for a TV to display content from a HDMI device.
- If the TV does not recognise the HDMI device and no picture is displayed, try switching the source from one device to another and back again.
- If there are intermittent sound disruptions, check that output settings from the HDMI device are correct.
- If you use an HDMI-to-DVI adapter or HDMI-to-DVI cable, check that an additional audio cable is connected to **AUDIO** (mini-jack only).

Computer connection issues

The computer display on the TV is not stable:

- Check that your PC uses the supported resolution and refresh rate.
- Set the TV picture format to unscaled.

Contact us

If you cannot resolve your problem, refer to the FAQs for this product at www.philips.com/support. If the problem remains unresolved, contact Philips Consumer Care in your country as listed in the Addendum.



Warning

- Do not attempt to repair the product yourself. This may cause severe injury, irreparable damage to your product or void your warranty.



Note

- Make a note of your TV model and serial number before you contact Philips. These numbers are printed on the back of the TV and on the packaging.

11 Index

A	
Analogue	29
Fine tune	29
ANTENNA	41
<hr/>	
B	
Batteries	5, 48
Blue mute	38
<hr/>	
C	
CAM	45
Channel list	
Channel decoder	27
favourite	18
Grid	10
Install	28
Automatic	28
Manual	29
MyChoice channel	40
Rearrange	30
Rename	30
Test digital reception	30
Troubleshooting	50
Update	28
Clock	20
Computer	
Connect	44
Display resolutions	48
Connector	
HDMI	41, 43
Overview	41
USB	43
Consumer setup	35
Country	28
<hr/>	
D	
Decoder	27
Demo	27
Digital channels	
CAM	45
Test digital reception	30
<hr/>	
E	
EasyLink	
Disable	46
Enable	46
HDMI-CEC in	37
One-touch play	46
One-touch standby	46
System audio control	46
ECO-Green	6
EPG	19
E-sticker	27
<hr/>	
F	
Factory settings	27
<hr/>	
H	
HDMI	
Connect devices	41
HDMI-CEC in	37
Troubleshooting	51
Home mode	26
<hr/>	
I	
Install channels	
Automatic	28
Manual	29
<hr/>	
K	
Kensington lock	47
<hr/>	
L	
Language	
Audio language	16
Menu language	28
Subtitle language	23
Troubleshooting	50
Lock	
Kensington lock	47
Local KB lock	37
Lock channel	22
RC lock	37
TV lock	22

M	
MENU	
Main menu	12
Professional mode setup menu	32
Teletext	17
Multimedia	
Product information	48
USB	24
Multi remote control	39
Music	25
Mute	11
MyChoice	39, 40
<hr/>	
O	
OAD	26
One-touch play	46
One-touch standby	46
On timer	21
<hr/>	
P	
Photo	
Slide show	24
USB	24
Picture format	15
Picture settings	14
PIN code	21
Professional mode	
Activate	32
Options	33
PBS mode	35
Store settings	40
<hr/>	
R	
Radio	25
Remote control	
Guest Remote control	8
Multi remote control	39
Professional Setup Remote control	31
RC lock	37
<hr/>	
S	
Selectable AV	38
Skip scrambled signals	39
Smart card	45
Smart power	35
Software version	26
Sound settings	16
Source list	11
Store	40
Subtitle	23
<hr/>	
T	
teletext	17
Teletext	11
Timer	21
Troubleshooting	50
<hr/>	
U	
Universal access	17
USB	
Disconnect	25
Enable USB	38
Listen to music	25
Software update	26
USB break-in	37
View photos	24
<hr/>	
V	
Video formats	48
Volume	11
<hr/>	
W	
Wall mount	49
Welcome message	36

