

PHILIPS



Search



Talk



Philips home

Let's make things better

▶ safety and troubleshooting

▶ about this manual

▶ product information

▶ installing your monitor

▶ on-screen display

▶ customer care and warranty

▶ glossary

▶ download & print

electronic

150X

USER'S MANUAL



Safety and Troubleshooting Information

[Safety Precautions and Maintenance](#) • [Installation Locations](#) • [Correct Handling of the LCD Monitor](#) • [FAQs](#) • [Troubleshooting](#) • [Regulatory Information](#) • [Other Related Information](#)

Safety precautions and maintenance



WARNING: Use of controls, adjustments, or procedures other than those specified in this documentation may result in exposure to shock, electrical hazards, and/or mechanical hazards.

Read and follow these instructions when connecting and using your computer monitor:

- Unplug the monitor, if you are not going to use it for an extensive period of time.
- Unplug the monitor, if you need to clean it with a slightly damp cloth. Wiping the screen with a dry cloth is possible when the power is off. However, never use alcohol, solvents, or ammonia-based liquids.
- Consult a service technician if the monitor does not operate normally when following the instructions in this manual.
- The casing cover should be opened only by qualified service personnel.
- Keep the monitor out of direct sunlight and away from stoves or any other heat source.
- Remove any object that could fall into the vents or prevent proper cooling of the monitor's electronics.
- Do not block the ventilation holes on the cabinet.
- Keep the monitor dry. To avoid electric shock, do not expose it to rain or excessive moisture.
- When positioning the monitor, make sure the power plug and outlet are easily accessible.
- If turning off the monitor by detaching power cable or DC power cord, wait for 6 seconds, then attach the power cable or DC power cord for normal operation.
- To avoid the risk of shock or permanent damage to the set, do not expose the monitor to rain or excessive moisture.
- When positioning the monitor, make sure the power plug and outlet are easily accessible.

Consult a service technician if the monitor does not operate normally when operating instructions of this manual are followed.

[RETURN TO TOP OF THE PAGE](#)

Installation Locations

- Avoid Heat and Extreme Cold
- Do not store or use the LCD monitor in locations exposed to heat, direct sunlight, or extreme cold.
- Avoid moving the LCD monitor between locations with large temperature differences. Choose a site

falling within the following temperature and humidity ranges.

- Temperature: 5-35°C 41-95°F
- Humidity: 20-80% RH
- Do not subject the LCD monitor to severe vibration or high impact conditions. Do not place the LCD monitor inside a car trunk.
- Take care not to mishandle this product by either knocking or dropping during operation or transportation.
- Do not store or use the LCD monitor in locations exposed to high humidity or a dusty environment. Also do not allow water or other liquids to spill on or into the LCD monitor.

[RETURN TO TOP OF THE PAGE](#)

Correct handling of the monitor

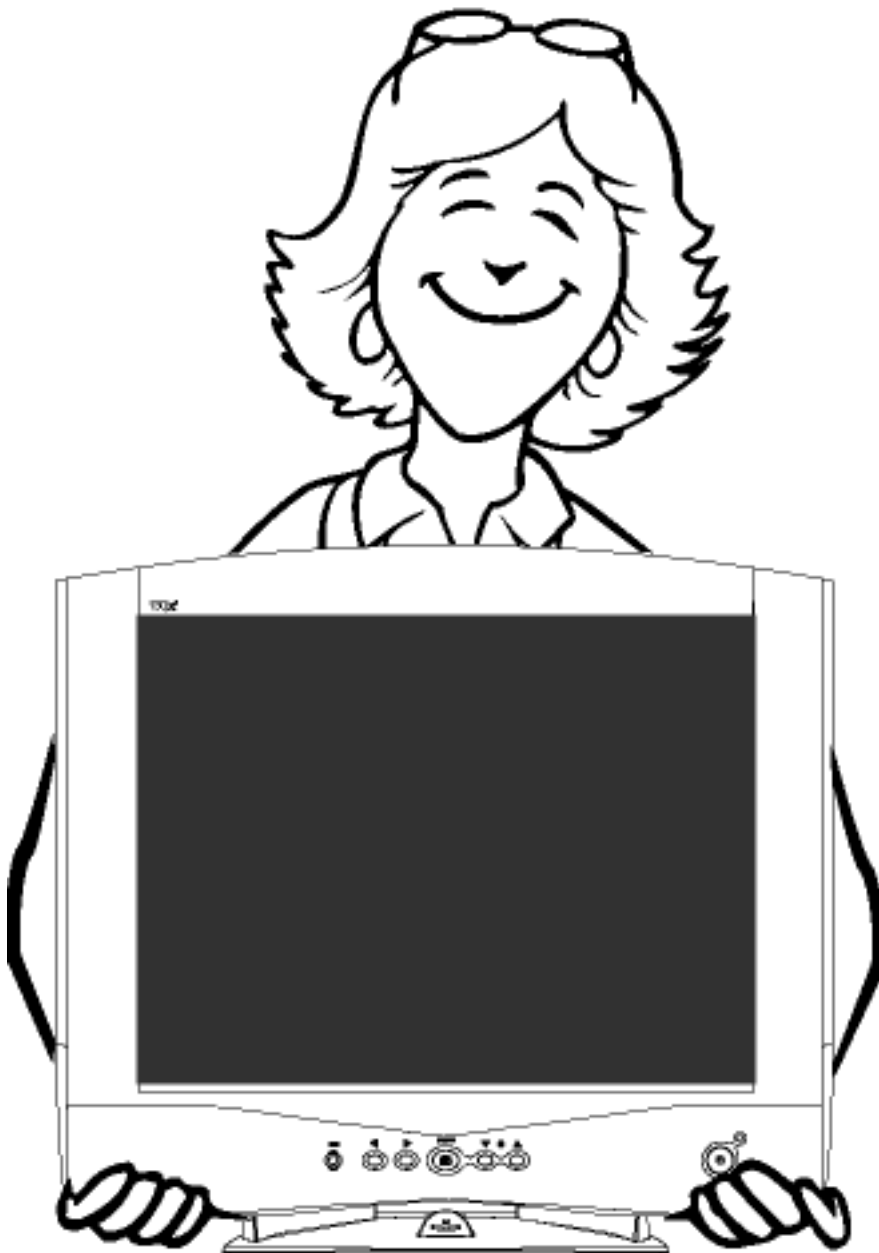

1. When handling the monitor, grip the bottom firmly with both hands and ensure that the front panel faces outward before lifting. Please refer to the diagram on the right.
2. Handling the monitor with care prevents scratching and damage. If the monitor becomes damaged, immediately disconnect the power from the unit and have it checked by a qualified service person before using it again.
3. To prevent fire or electrical shock, do not drop the monitor.
4. When moving the monitor, be sure to unplug all power cords in order to avoid injury or damage to the equipment.

[RETURN TO TOP OF THE PAGE](#)

About This Electronic User's Manual

[About This Guide](#) • [Other Documents You May Need](#) • [Notational Descriptions](#)

About This Guide

This electronic user's guide is intended for anyone who uses the Philips 150X LCD Monitor. It describes the LCD monitor's features, setup, operation and other pertinent information. Its contents are identical to the information in our printed version.

Sections are as follows:

- [Safety and Troubleshooting Information](#) provides tips and solutions for common problems as well as other related information you may need.
- About This Electronic User's Manual gives an overview of information included, along with notation icon descriptions and other documentation for your reference.
- [Product Information](#) gives an overview of the monitor's features and as well as the technical specifications for this monitor.
- [Installing Your Monitor](#) describes the initial setup process and gives an overview of how to use the monitor.
- [On Screen Display](#) provides information on adjusting the settings on your monitor.
- [Customer Care and Warranty](#) contains a list of worldwide Philips Consumer Information Centers along with help desk phone numbers and information on the warranty applicable to your product.
- [Glossary](#) defines technical terms.
- [Download and Print Option](#) transfers this entire manual to your hard drive for easy reference.

[RETURN TO TOP OF THE PAGE](#)

Other Documents You May Need

In addition to this *Electronic User's Guide*, you may need to refer to the following documentation:

- *Philips LCD Monitor Quick Start Guide* which summarizes the steps for setting up the monitor. This is included with this product.

[RETURN TO TOP OF THE PAGE](#)

Notational Descriptions

The following subsections describe notational conventions used in this document.

Notes, Cautions, and Warnings

Throughout this guide, blocks of text may be accompanied by an icon and printed in bold or italic type. These blocks contain notes, cautions, or warnings. They are used as follows:



NOTE: This icon indicates important information and tips that help you make better use of your computer system.



CAUTION: This icon indicates information that tells you how to avoid either potential damage to hardware or loss of data.



WARNING: This icon indicates the potential for bodily harm and tells you how to avoid the problem.



SMART HELP: This icon indicates helpful information when adjusting the On Screen Display of your monitor.

Some warnings may appear in alternate formats and may be unaccompanied by an icon. In such cases, the specific presentation of the warning is mandated by regulatory authority.

[RETURN TO TOP OF THE PAGE](#)

©1999 Koninklijke Philips Electronics N.V.

All rights reserved. Reproduction, copying, usage, modifying, hiring, renting, public performance, transmission and/or broadcasting in whole or in part is prohibited without written consent of Philips Electronics N.V.

Product Information

[Product Features](#) • [Technical Specifications](#) • [Resolution & Preset Modes](#) • [Philips Pixel Defect Policy](#) • [Automatic Power Saving](#) • [Physical Specification](#) • [Pin Assignment](#) • [Product Views](#) • [Attention Signals](#)

Product Features

Brilliance 150X

- 15" LCD monitor with high-tech design and excellent display performance.
- New DVI standard for both digital and analog interface.
- Front firing speakers with 36W PMPO stereo sound output
- Sliding height adjustment for the best viewing position.
- Wide viewing angle technology.
- AUTO adjustment automatically optimizes picture quality.

[RETURN TO TOP OF THE PAGE](#)

Technical Specifications*

LCD PANEL

| | |
|--------------------------|---|
| • Type | TFT LCD |
| • Screen size | 15.0" / 38.1 diagonal |
| • Pixel Pitch | 0.297 x 0.297mm |
| • LCD Panel type | 1024 x 768 pixels R.G.B. vertical stripe Anti-glare polarizer hard coated |
| • Effective viewing area | 304.1 x 228.1mm |
| • Display Colors | 8 bits interface (16M colors) |

VIDEO

| | |
|-----------------------|---------|
| • Video dot rate | 80 MHz |
| • Input impedance | |
| - Video | 75 Ohm |
| - Sync | 2K Ohm |
| • Input signal levels | 0.7 Vpp |

| | |
|---------------------|---|
| • Sync input signal | Separate sync Composite sync Sync on green |
| • Sync polarities | Positive and negative |
| • Input Frequency | XGA Hsync 48- 60 KHz, Vsync 60 - 75 Hz (N.I.) SVGA Hsync 35- 50 KHz, Vsync 56 - 75 Hz (N.I.) VGA Hsync 31- 38 KHz, Vsync 60 - 75 Hz (N.I.) |
| • Video interface | <i>Dual input.</i> It can be switching via OSD selection. DVI-I (Integrated) interface, which both provides analog and digital interface. |
| | |

AUDIO

| | |
|------------------------------|--|
| • Input signal levels | 0.7 Vpp |
| • Headphone out signal level | 32 Ohm 20 + 20 mW |
| • Input signal connector | 3.5mm mini jack |
| • Loudspeakers | 2 + 2 W stereo front firing (PMPO 36W) |
| | |

MICROPHONE

| | |
|--------------------|---------------------------|
| • Sensitivity | -55dB re 1V/ubar at 1 KHz |
| • Output impedance | 2.2K Ohm max |
| • Directivity | -5dB at 180° |
| • Frequency range | 300Hz~3KHz |
| | |

OPTICAL CHARACTERISTICS

| | |
|--------------------------|--|
| • Contrast ratio | 350(typ.) |
| • Brightness | 250 cd/m ² (typ.) |
| • Peak contrast angle | 6 o'clock |
| • White Chromacity | x: 0.281 y: 0.311 (at 9300° K) x: 0.312 y: 0.338 (at 6500° K) |
| • Viewing Angle (C/R >5) | Upper ≥70 ° (typ.) Lower ≥70° (typ.) Left ≥80 ° (typ.) Right ≥80 ° (typ.) |
| • Response time | ≤45ms (typ.) |

* These information are subject to change without notice.

[RETURN TO TOP OF THE PAGE](#)

Resolution & Preset Modes

- Maximum 1024 x 768 at 75Hz
- Recommended 1024x768 at 60Hz

14 USER DEFINABLE MODES

14 factory preset modes:

| dot rate (MHz) | H. freq (KHz) | Mode | Resolution | V. freq (KHz) |
|----------------|---------------|-------------|------------|---------------|
| 25.175 | 31.469 | IBM VGA 10h | 640*350 | 70.086 |
| 28.322 | 31.469 | IBM VGA 3h | 720*400 | 70.087 |
| 25.175 | 31.469 | IBM VGA 12h | 640*480 | 59.940 |
| 30.200 | 35.000 | MACINTOSH | 640*480 | 67.000 |
| 31.500 | 37.861 | VESA | 640*480 | 72.809 |
| 31.500 | 37.500 | VESA | 640*480 | 75.000 |
| 36.000 | 35.156 | VESA | 800*600 | 56.250 |
| 40.000 | 37.879 | VESA | 800*600 | 60.317 |
| 50.000 | 48.077 | VESA | 800*600 | 72.188 |
| 49.500 | 46.875 | VESA | 800*600 | 75.000 |
| 57.300 | 49.700 | MACINTOSH | 832*624 | 75.000 |
| 65.000 | 48.363 | VESA | 1024*768 | 60.004 |
| 75.000 | 56.476 | VESA | 1024*768 | 70.069 |
| 78.750 | 60.023 | VESA | 1024*768 | 75.029 |

[RETURN TO TOP OF THE PAGE](#)

Automatic Power Saving

If you have VESA's DPMS compliance display card or software installed in your PC, the monitor can automatically reduce its power consumption when not in use. And if an input from a keyboard, mouse or other input device is detected, the monitor will automatically "wake up". The following table shows the power consumption and signaling of this automatic power saving features:

Power Management Definition

| VESA Mode | Video | H-sync | V-sync | Power Used | Power Saving (%) | LED color |
|-----------|---------|--------|--------|------------|------------------|-----------|
| ON | Active | Yes | Yes | < 25W | 0 % | Green |
| Stand-by | Blanked | No | Yes | < 5W | 83.3% | Amber |
| Suspend | Blanked | Yes | No | < 5W | 83.3% | Amber |
| OFF | Blanked | No | No | < 3W | 90% | Amber |

This monitor is ENERGY STAR® compliant. As an ENERGY STAR® Partner, PHILIPS has determined that this product meets the ENERGY STAR® guidelines for energy efficiency.

[RETURN TO TOP OF THE PAGE](#)

Physical Specifications

| | |
|-----------------------------|--|
| • Dimension (WxHxD) | 393.6 x 364.8x 206 mm (incl. Pedestal) |
| • Weight | 5.3 Kg |
| • Tilt (Forward / Backward) | -5/ +25 |
| • Power supply | 100 — 240 VAC, 50/60 Hz |
| • Power consumption | 23 W |
| • Temperature (operating) | -20° C to +60° C |
| • Relative humidity | 20% to 80% |
| • System MTBF | 50K hrs (excluding LCD panel, CCFL) |

* These information are subject to change without notice.

[RETURN TO TOP OF THE PAGE](#)

Signal Pin Assignment

The digital only connector contains 24 signal contacts organized in three rows of eight contacts. Signal pin assignments are listed in below:

DVI-D Pin Assignment

| Pin No. | Signal Assignment | Pin No. | Signal Assignment | Pin No. | Signal Assignment |
|---------|-------------------------|---------|-------------------------|---------|-------------------------|
| 1 | T.M.D.S. Data2- | 9 | T.M.D.S. Data1- | 17 | T.M.D.S. Data0- |
| 2 | T.M.D.S. Data2+ | 10 | T.M.D.S. Data1+ | 18 | T.M.D.S. Data0+ |
| 3 | T.M.D.S. Data2/4 Shield | 11 | T.M.D.S. Data1/3 Shield | 19 | T.M.D.S. Data0/5 Shield |
| 4 | T.M.D.S. Data4- | 12 | T.M.D.S. Data3- | 20 | T.M.D.S. Data5- |
| 5 | T.M.D.S. Data4+ | 13 | T.M.D.S. Data3+ | 21 | T.M.D.S. Data5+ |
| 6 | DDC Clock | 14 | +5V Power | 22 | T.M.D.S. Clock Shield |
| 7 | DDC Data | 15 | Ground (for +5V) | 23 | T.M.D.S. Clock+ |
| 8 | No connect | 16 | Hot Plug Detect | 24 | T.M.D.S. Clock- |

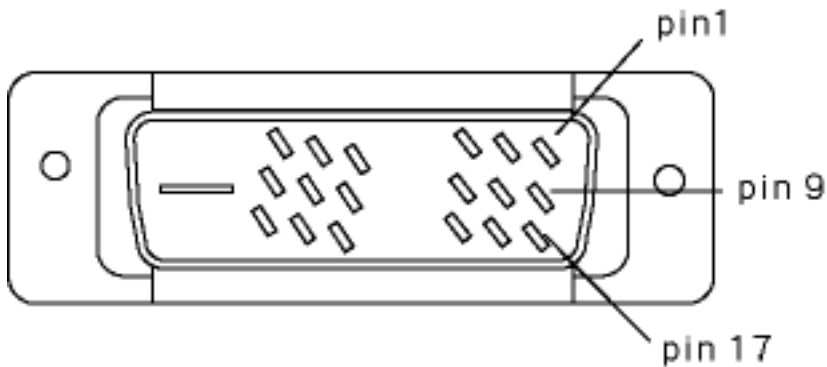

DVI-I Pin Assignment

| Pin No. | Signal Assignment | Pin No. | Signal Assignment | Pin No. | Signal Assignment |
|---------|-------------------------|---------|------------------------------------|---------|-------------------------|
| 1 | T.M.D.S. Data2- | 9 | T.M.D.S. Data1- | 17 | T.M.D.S. Data0- |
| 2 | T.M.D.S. Data2+ | 10 | T.M.D.S. Data1+ | 18 | T.M.D.S. Data0+ |
| 3 | T.M.D.S. Data2/4 Shield | 11 | T.M.D.S. Data1/3 Shield | 19 | T.M.D.S. Data0/5 Shield |
| 4 | T.M.D.S. Data4- | 12 | T.M.D.S. Data3- | 20 | T.M.D.S. Data5- |
| 5 | T.M.D.S. Data4+ | 13 | T.M.D.S. Data3+ | 21 | T.M.D.S. Data5+ |
| 6 | DDC Clock | 14 | +5V Power | 22 | T.M.D.S. Clock Shield |
| 7 | DDC Data | 15 | Ground (for +5V, Analog H/V Sync)) | 23 | T.M.D.S. Clock+ |
| 8 | Analog Vertical Sync | 16 | Hot Plug Detect | 24 | T.M.D.S. Clock- |

"MicroCross:"/high speed pins:

C1: Analog Red video Out

C2: Analog Green Video Out

C3: Analog Blue Video Out

C4: Analog Horizontal Sync

C5: Analog Common Ground Return (Red, Green, Blue Video Out)

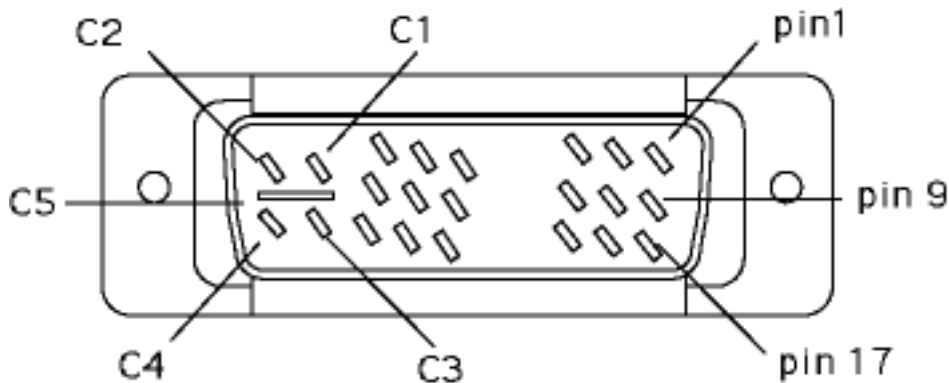

[RETURN TO TOP OF THE PAGE](#)

Views

Follow the links to see various views of the monitor and its components.

[Front View Product Description](#) [Rear View Product Description](#) [Side View Product Description](#)

Attention Signals

Attention Signals

Attention signal display information and alerts about the status of the monitor.

1. **CANNOT DISPLAY THIS VIDEO MODE, CHANGE COMPUTER DISPLAY INPUT TO 1024X768 @ 60Hz**

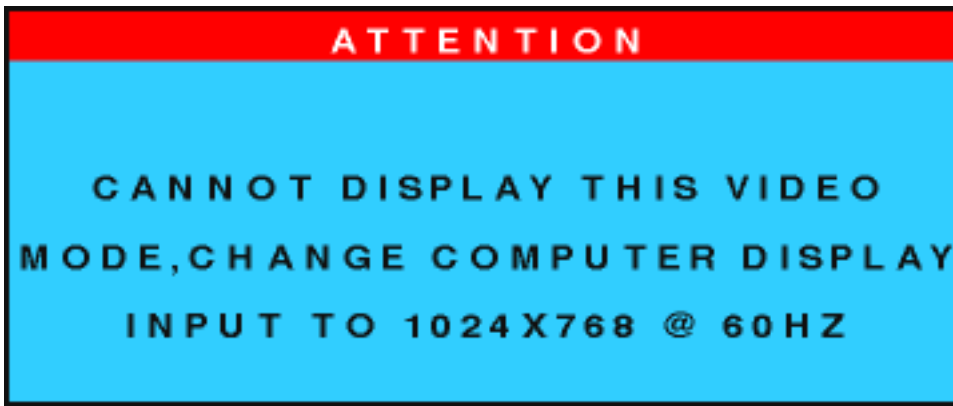

-- This warning appears when the input signal from your computer is not in a standard video mode or is out of the monitor's scanning range.

Solution: For best display performance, reset the display mode of your computer to 1024x768@60Hz for 14" or 15" models.

2. NO VIDEO INPUT



-- This message appears when there is no signal input.

Solution: Make sure interface and power cables are properly connected.

3. CHECK CABLE CONNECTION

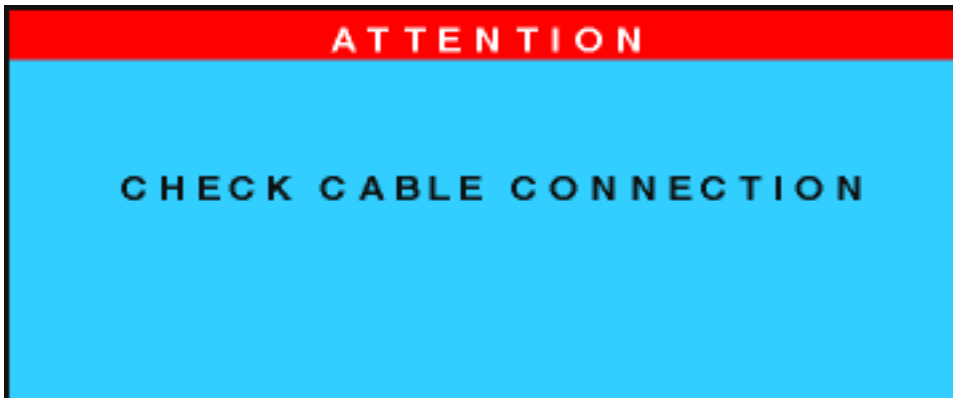

-- This message appears when a signal cable is disconnected while computer is working.

Solution: Re-connect signal input cables.

4. **ENTERING SLEEP MODE**



-- This message appears when monitor is about to enter power saving. To wake up monitor, press any key or click on mouse.

5. **WAITING FOR AUTOMATIC ADJUSTMENT**



-- This message is displayed when the auto adjustment button is pressed. It disappears when automatic adjustments are completed.

6. **SECOND VIDEO IS NOT AVAILABLE**



-- This message appears when a user selects a second unavailable video source from the OSD from the INPUT SELECTION menu of OSD.

-- On systems with both analog and digital output, this screen may appear when a signal other than the default signal type is received.

[RETURN TO TOP OF THE PAGE](#)

Installing your LCD Monitor

Your LCD Monitor : [Front View Product Description](#) • [Connecting to Your PC](#) • [Getting Started](#) • [Optimizing Performance](#)

Front View

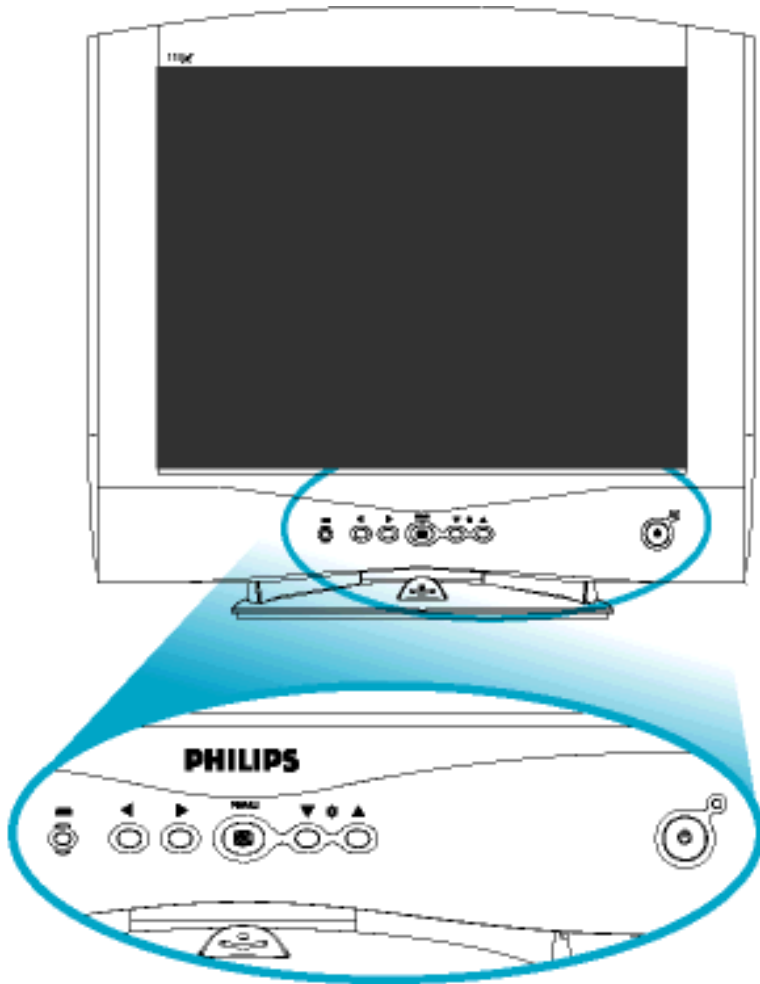

UP and DOWN buttons are used when adjusting the OSD of your monitor





LEFT and RIGHT buttons, like the UP and DOWN buttons, are also used in adjusting the OSD of your monitor.



BRIGHTNESS hotkey. When the UP and DOWN arrow buttons are pressed, the adjustment controls for the BRIGHTNESS will show up.

 .OK button which when pressed will take you to the OSD controls

 POWER button switches your monitor on

 Automatically adjust the horizontal position, vertical position, phase and clock setting.

[RETURN TO TOP OF THE PAGE](#)

Rear View

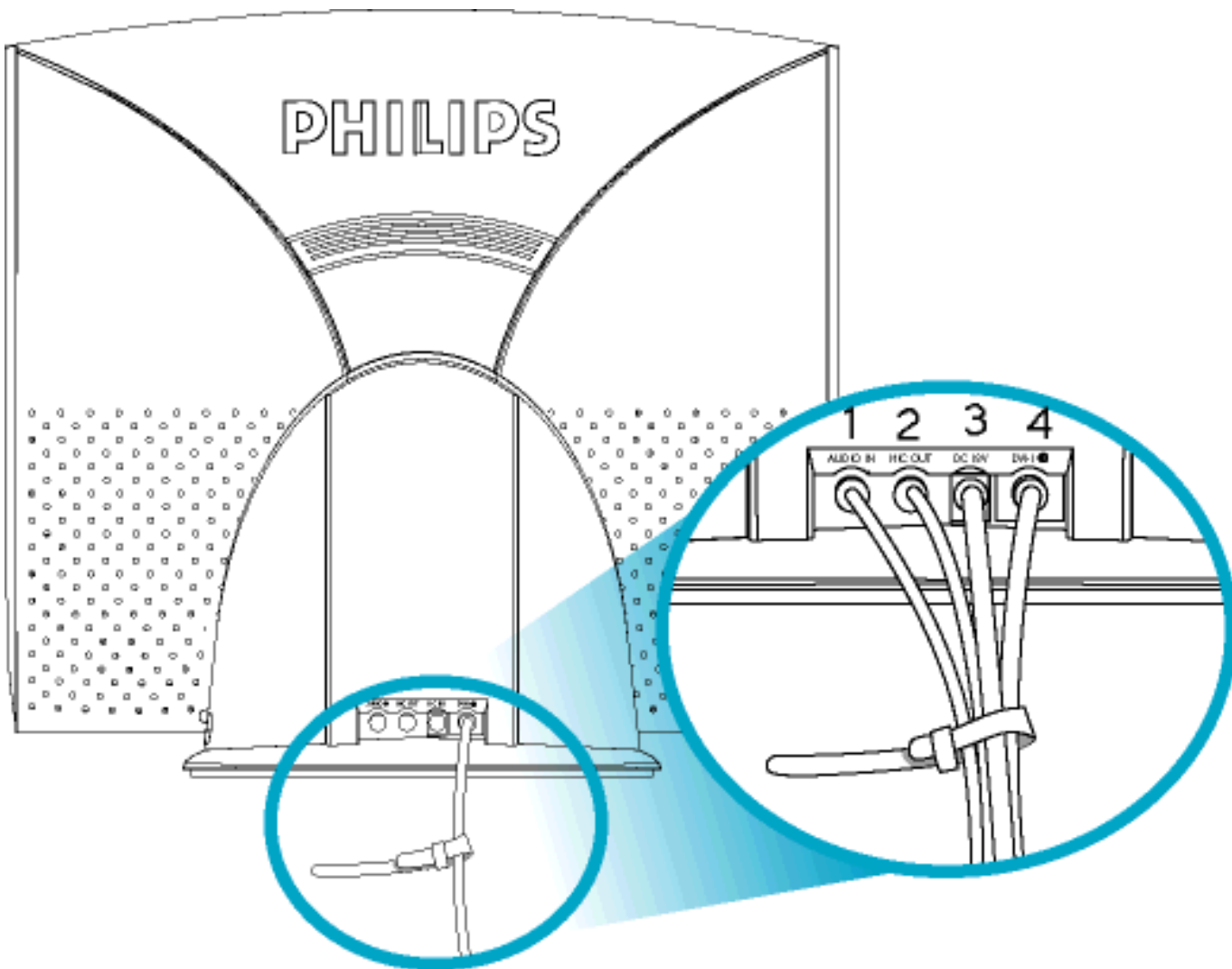

1.Audio in For audio in

2.Mic out For microphone output

3.DC 18V This monitor only accepts DC 18V power in

4.DVI-I  This monitor is DVI-I (digital & VGA) interface standard

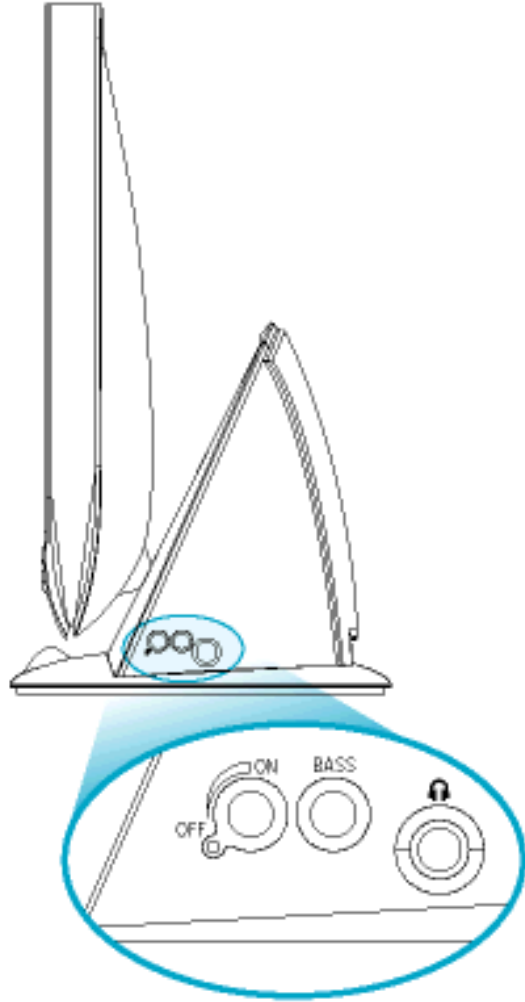

[RETURN TO TOP OF THE PAGE](#)

Side View



Audio power on/off and volume adjustment

Audio power led

BASS:  (on)  (off)

BASS on/off



Headphone jack

[RETURN TO TOP OF THE PAGE](#)

Optimizing Performance

- For best performance, ensure that your display settings are set at 1024x768@60Hz (for 14" & 15") or 1280x1024@60Hz (for 17" & 18").



Note: You can check the current display settings by pressing the OSD "OK" button once. Go into the Product Information. The current display mode is shown on the item called RESOLUTION.

- You can also install the [Flat Panel Adjust \(FP Adjust\) program](#), a program for getting the best performance out of your monitor, included in this CD. A step-by-step instructions is provided to guide you through the installtion process. Click on the link to down load and then to know more about this program.

More about



[FPadjust Program](#)

[RETURN TO TOP OF THE PAGE](#)

On-Screen Display





[Description of the On-Screen Display](#) • [The OSD Tree](#) • [The OSD Controls](#)

Description of the On Screen Display

What is the On-Screen Display?

This is a feature in all Philips LCD monitors which allows an end-user to adjust screen performance of monitors directly through an on-screen instruction window. The user interface provides user-friendliness and ease-of-use when operating the monitor.

Basic and simple instruction on the control keys.

On the front controls of your monitor, once you press the  button, the On Screen Display (OSD) Main Controls window will pop up and you can now start making adjustments to your monitor's various features. Use the   or the   keys to make your adjustments within.

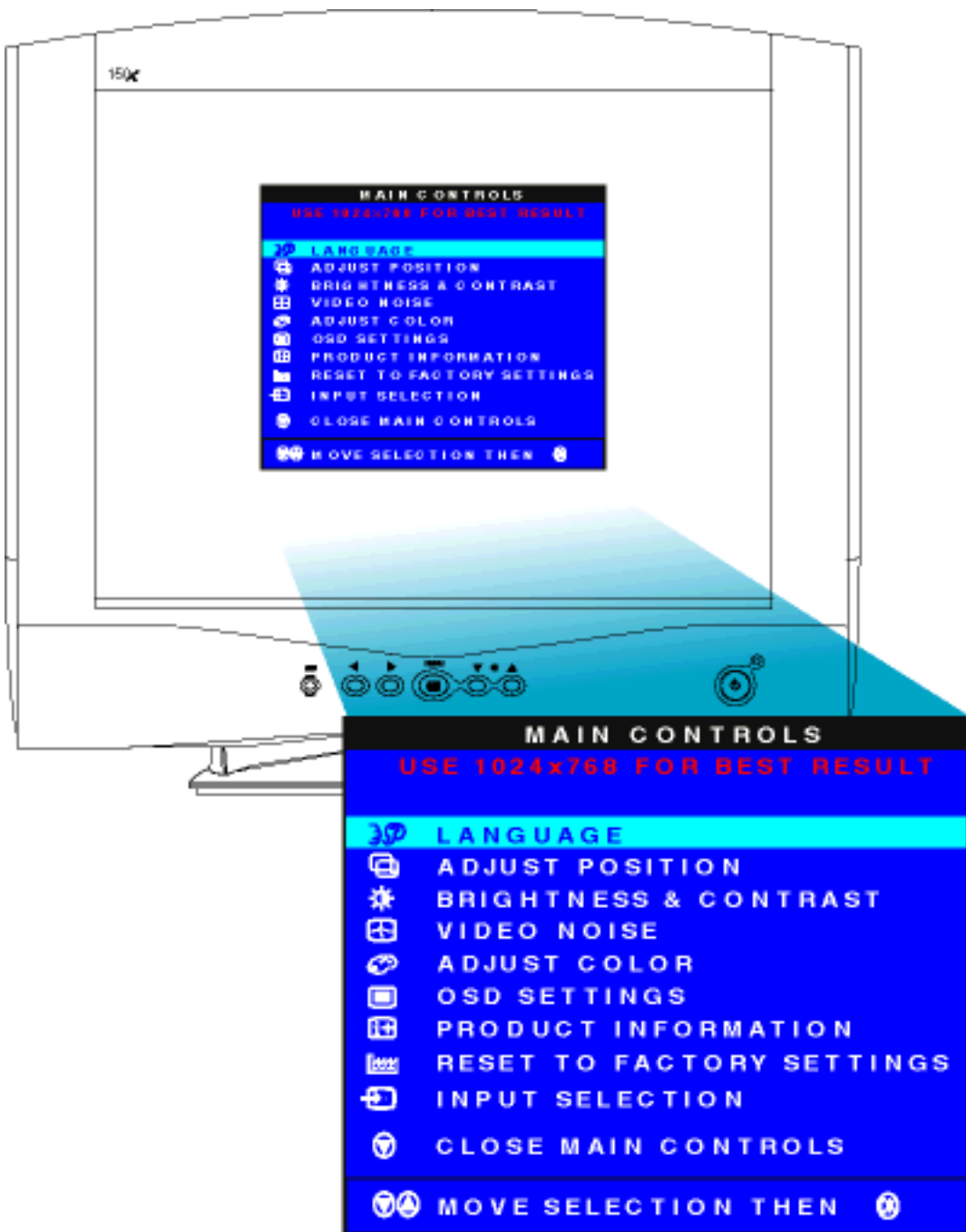

[RETURN TO TOP OF THE PAGE](#)

The OSD Tree

Below is an overall view of the structure of the On-Screen Display. You can use this as reference when you want to later on work your way around the different adjustments.

Analog signal input:

Analog

First Level

Second Level

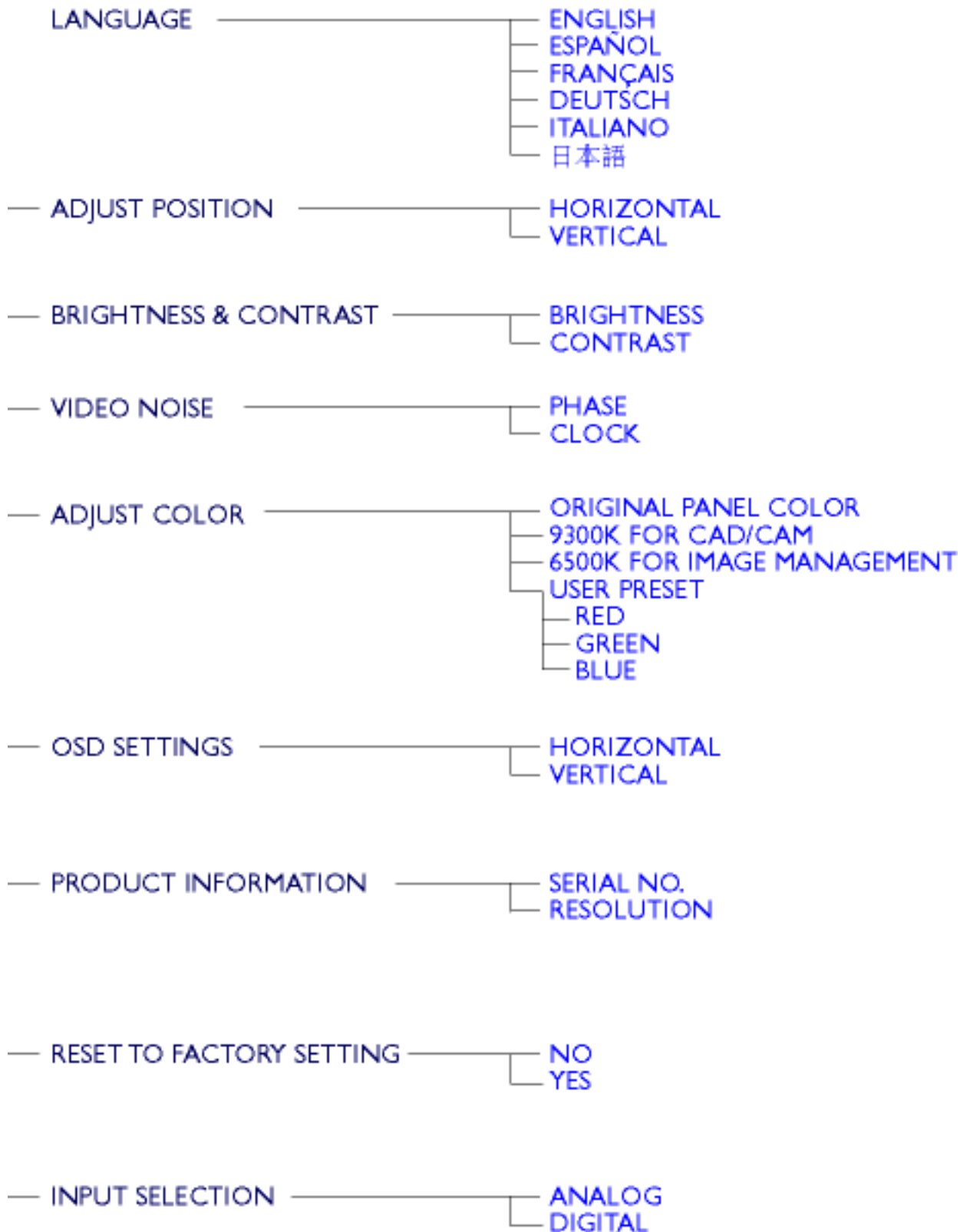

CLOSE MAIN CONTROLS

Digital signal input:

Digital

First Level

Second Level

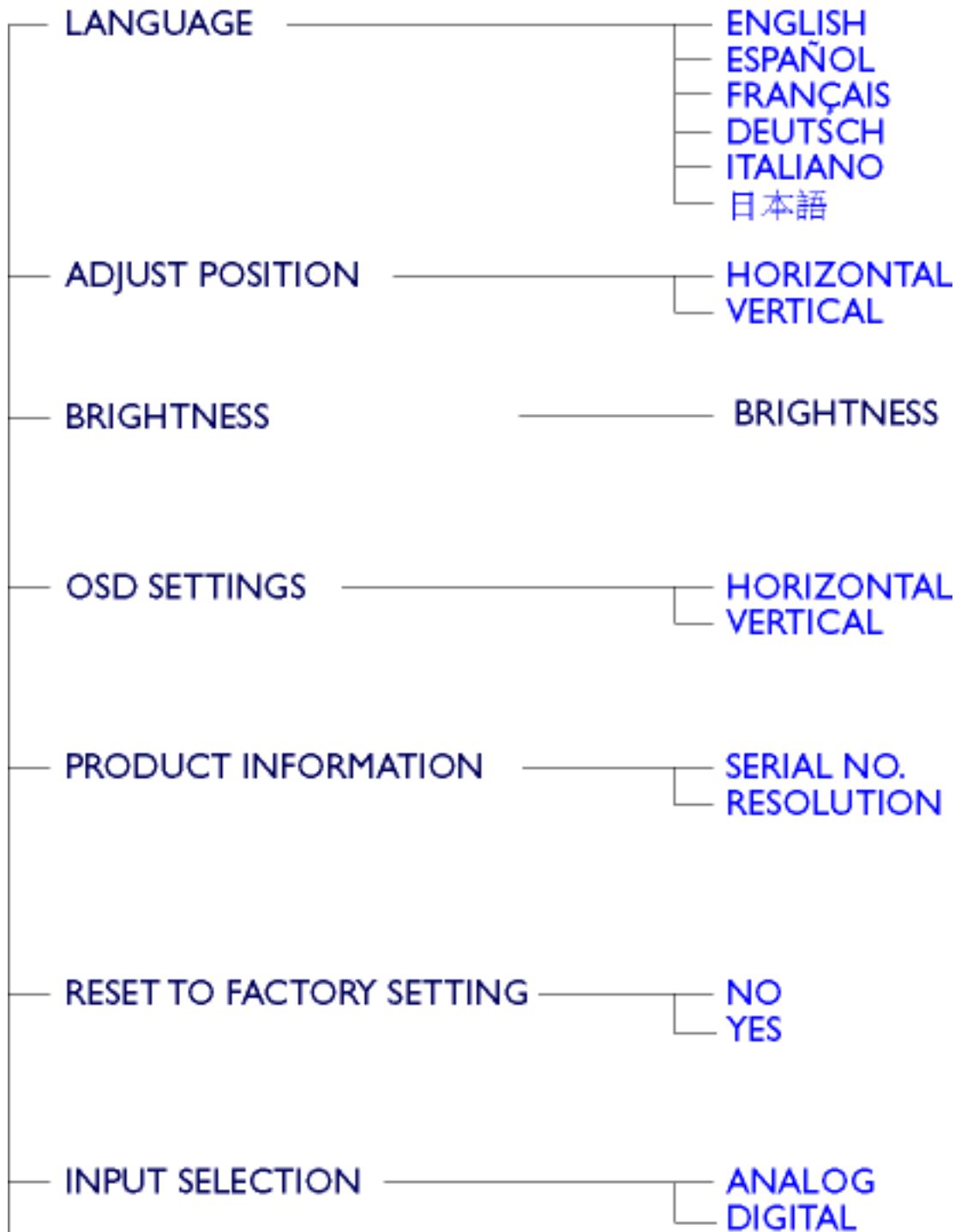

CLOSE MAIN CONTROLS

[RETURN TO TOP OF THE PAGE](#)

Customer Care & Warranty

PLEASE SELECT YOUR COUNTRY/AREA TO REVIEW DETAILS OF YOUR WARRANTY COVERAGE

WESTERN EUROPE: [Austria](#) • [Belgium](#) • [Cyprus](#) • [Denmark](#) • [France](#) • [Germany](#) • [Greece](#) • [Finland](#) • [Ireland](#) • [Italy](#) • [Luxembourg](#) • [the Netherlands](#) • [Norway](#) • [Portugal](#) • [Sweden](#) • [Switzerland](#) • [Spain](#) • [United Kingdom](#)

EASTERN EUROPE: [Czech Republic](#) • [Hungary](#) • [Poland](#) • [Russia](#) • [Turkey](#)

LATIN AMERICA: [Antilles](#) • [Argentina](#) • [Brasil](#) • [Chile](#) • [Colombia](#) • [Mexico](#) • [Paraguay](#) • [Peru](#) • [Uruguay](#) • [Venezuela](#)

NORTH AMERICA: [Canada](#) • [USA](#)

PACIFIC: [Australia](#) • [New Zealand](#)

ASIA: [Bangladesh](#) • [China](#) • [Hong Kong](#) • [India](#) • [Indonesia](#) • [Japan](#) • [Korea](#) • [Malaysia](#) • [Pakistan](#) • [Philippines](#) • [Singapore](#) • [Taiwan](#) • [Thailand](#)

AFRICA: [Morocco](#) • [South Africa](#)

MIDDLE EAST: [Dubai](#) • [Egypt](#)

Glossary

A B C D E F G H I J K L M N O P Q R S T U V W X Y Z

B

BNC connection

A bayonet-locking connector slim coaxial cables. The connection is used in some monitors with high horizontal scanning frequencies. It provides optimum shielding between the video input signal lines to give the best possible video performance.

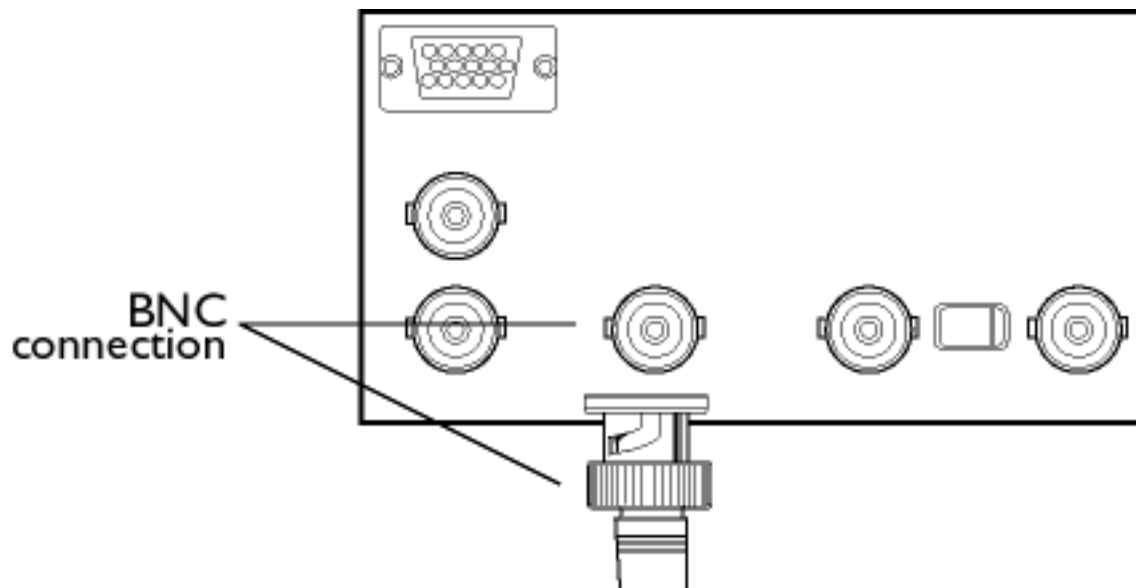

[RETURN TO TOP OF THE PAGE](#)

C

Color temperature

A way of describing the color of a radiating source in terms of the temperature (in degrees Kelvin) of a black body radiating with the same dominant frequency as the source.

Most Philips monitors offer the possibility of setting the color temperature to any desired value.

CustoMax

Philips proprietary monitor control software that allows users to control parameters (e.g., Size, Color, Geometry) using software running in Windows. CustoMax is compatible with existing VGA cards. See CrystalClear FAQ and USB Bay FAQ.

[RETURN TO TOP OF THE PAGE](#)

D

D-SUB USB

Your monitor comes with a D-Sub cable.

Digital Visual Interface (DVI)

The Digital Visual Interface (DVI) specification provides a high-speed digital connection for visual data types that is display technology independent. The interface is primarily focused at providing a connection between a computer and its display device. The DVI specification meets the needs of all segments of the PC industry (workstation, desktop, laptop, etc.) and will enable these different segments to unite around one monitor interface specification.

The DVI interface enables:

1. Content to remain in the lossless digital domain from creation to consumption.
2. Display technology independence.
3. Plug and play through hot plug detection, EDID and DDC2B.
4. Digital and Analog support in a single connector.

[RETURN TO TOP OF THE PAGE](#)

E

Energy Star Computers Programme

An energy conservation programme launched by the US Environmental Protection Agency (EPA) with the primary aim of promoting the manufacture and marketing of energy-efficient office automation equipment. Companies joining this programme must be willing to commit themselves to manufacturing one or more products capable of going into a low -power state (< 30 W) either after a period of inactivity or after a predetermined time selected by the user.

[RETURN TO TOP OF THE PAGE](#)

L

LCD Liquid Crystal Display

An alphanumeric display using the unique properties of liquid crystal to form characters. The latest flat-panel displays comprise a matrix of hundreds or thousands of individual LCD cells that generate text and colorful graphics on a screen. They consume little power though they do require external lighting to make them legible to the user.

[RETURN TO TOP OF THE PAGE](#)

U

USB or Universal Serial Bus

A smart plug for PC peripherals. USB automatically determines resources (like driver software and bus bandwidth) required by peripherals. USB makes necessary resources available without user intervention.

- USB eliminates "case angst" -- the fear of removing the computer case to install add-on peripherals. And USB also eliminates adjustment of complicated IRQ settings when installing new peripherals.
- USB does away with "port gridlock." Without USB, PCs are normally limited to one printer, two Com port devices (usually a mouse and modem), one Enhanced Parallel Port add-on (scanner or video camera, for example) and a joystick. More and more peripherals for multimedia computers arrive on the market every day. With USB, up to 127 devices can run simultaneously on a computer.
- USB permits "hot plug-in." There's no need to shut down, plug in, reboot and run set-up to install peripherals. And no need to go through the reverse process to unplug a device.

In short, USB transforms today's "Plug-and-Pray" into true Plug-and-Play!

Hub

A Universal Serial Bus device that provides additional connections to the Universal Serial Bus.

Hubs are a key element in the plug-and-play architecture of USB. The Figure shows a typical hub. Hubs serve to simplify USB connectivity from the user's perspective and provide robustness at low cost and complexity.

Hubs are wiring concentrators and enable the multiple attachment characteristics of USB. Attachment points are referred to as ports. Each hub converts a single attachment point into multiple attachment points. The architecture supports concatenation of multiple hubs.

The upstream port of a hub connects the hub towards the host. Each of the other downstream ports of a hub allows connection to another hub or function. Hubs can detect, attach and detach at each downstream port and enable the distribution of power to downstream devices. Each downstream port can be individually enabled and configured at either full or low speed. The hub isolates low speed ports from full speed signaling.

A hub consists of two portions: the Hub Controller and Hub Repeater. The repeater is a protocol-controlled switch between the upstream port and downstream ports. It also has hardware support for reset and suspend/resume signaling. The controller provides the interface registers to allow communication to/from the host. Hub specific status and control commands permit the host to configure a hub and to monitor and control

its ports.

Device

A logical or physical entity that performs a function. The actual entity described depends on the context of the reference. At the lowest level, device may refer to a single hardware component, as in a memory device. At a higher level, it may refer to a collection of hardware components that perform a particular function, such as a Universal Serial Bus interface device. At an even higher level, device may refer to the function performed by an entity attached to the Universal Serial Bus; for example, a data/FAX modem device. Devices may be physical, electrical, addressable, and logical.

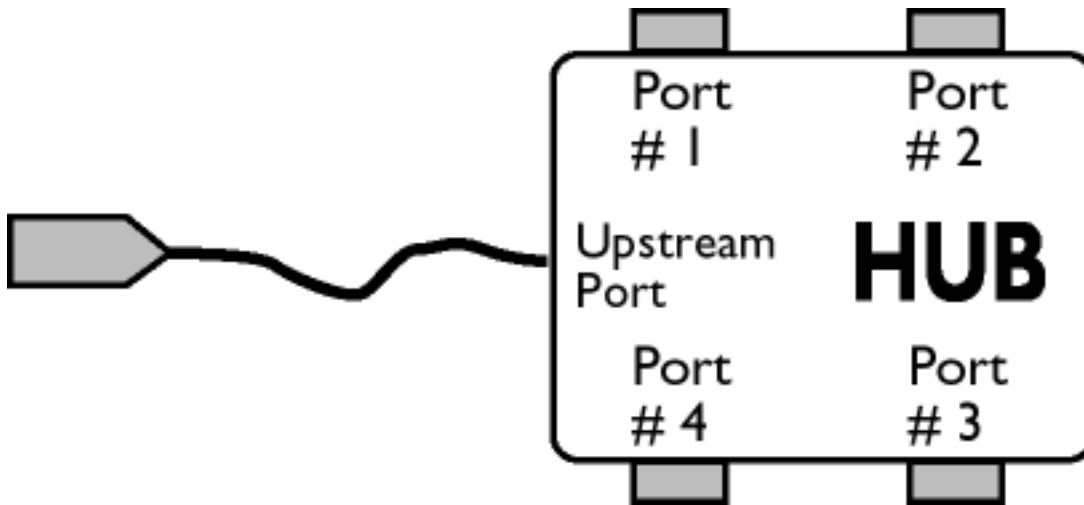

Downstream

The direction of data flow from the host or away from the host. A downstream port is the port on a hub electrically farthest from the host that generates downstream data traffic from the hub. Downstream ports receive upstream data traffic.

Upstream

The direction of data flow towards the host. An upstream port is the port on a device electrically closest to the host that generates upstream data traffic from the hub. Upstream ports receive downstream data traffic.

[RETURN TO TOP OF THE PAGE](#)

V

Vertical refresh rate

Expressed in Hz, it is the number of frames (complete pictures) written to the screen every second.

[RETURN TO TOP OF THE PAGE](#)

Download and Print

[Download and Printing Instructions](#) • [Installing FPadjust Program](#)

This page provides an option to read the manual in .pdf format. PDF files can be downloaded into your hard disk, then viewed and printed with Acrobat Reader or through your browser.

If you do not have Adobe® Acrobat Reader installed, click on the link to install the application. [Adobe® Acrobat Reader for PC](#) / [Adobe® Acrobat Reader for Mac](#).

Download instructions:

To download the file:

1. Click-and-hold your mouse over the icon below. (Win95/98 users right-click)

Download  [140S.pdf](#)

Download  [150B.pdf](#)

Download  [150S.pdf](#)

Download  [150P.pdf](#)

Download  [150X.pdf](#)

Download  [170B.pdf](#)

Download  [180P.pdf](#)

2. From the menu that appears, choose 'Save Link As...', 'Save Target As...' or 'Download Link to Disk'.

3. Choose where you would like to save the file; click 'Save' (if prompted to save as either 'text' or 'source', choose 'source').

Printing instructions:

To print the manual:

1. With the manual file open, follow your printer's instructions and print the pages you need.

[RETURN TO TOP OF THE PAGE](#)

Installing FPadjust Program

The FP Adjust program generates alignment patterns which will help you adjust monitor settings such as CONTRAST, BRIGHTNESS, HORIZONTAL & VERTICAL POSITION, PHASE and CLOCK.

System requirements:

- PC running Window 95, Window 98 or later

To install [FPadjust Program](#):

- Click on the link or icon to install FPadjustment Program.
- or
- Click-and-hold your mouse over the icon. (Win95/98 users right-click)

Download



[FPadjust \(SETUP.EXE\)](#)

- From the menu that appears, choose 'Save Link As...', 'Save Target As...' or 'Download Link to Disk'.
- Choose where you would like to save the file; click 'Save' (if prompted to save as either 'text' or 'source', choose 'source').
- Exit your browser and install the FPadjust Program.

Read the "ReadMe.txt" file before installing.

[RETURN TO TOP OF THE PAGE](#)

FAQs (Frequently Asked Questions)

[Safety and Troubleshooting](#) • [General FAQ](#) • [Screen Adjustments](#) • [Compatibility with Other Peripherals](#) • [LCD Panel Technology](#) • [Ergonomics, Ecology, and Safety Standards](#) • [Troubleshooting](#) • [Regulatory Information](#) • [Other Related Information](#)

General FAQs

Q: When I install my monitor how do I do if the screen shows "Cannot display this video mode"?

A: Recommended video mode for Philips 150P/150B/140S: 1024x768 @60Hz for Philips 181AS 1280x1024@60Hz.

- Unplug all cables, then connect your PC to the monitor that you used previously and which displayed correctly.
 - In the Windows Start Menu, select Settings/Control Panel. In the Control Panel Window, select the Display icon. Inside the Display Control Panel, select the " Settings " tab. Under the setting tab, in box labeled " desktop area ", move the slider to 1024x768 pixels .
 - Open " Advanced Properties " and set the Refresh Rate to 60Hz, then click OK.
 - Restart your computer and repeat step 2 and 3 to verify that your PC is set at 1024x768, 60Hz.
 - Shut down your computer, disconnect your old monitor and reconnect your Philips LCD monitor.
 - Turn on your monitor and then turn on your PC
-

Q: What does "refresh rate" mean to me in an LCD monitor?

A: For LCD monitors, the refresh rate is much less relevant. LCD monitors display a stable, flicker-free image at 60Hz. There is no visible differences between 85Hz and 60Hz.

Q: What are the .inf and .icm files on the setup disk & CD-ROM? How do I install the drivers (.inf and .icm)?

A: These are the driver files for your monitor. Follow the instructions in your user manual to install the drivers. You computer may ask you for monitor drivers (.inf and .icm files) or a driver disk when you first install your monitor. Follow the instructions to insert the driver disk (either floppy or CD-ROM) included in this package. Monitor drivers (.inf and .icm files) will be installed automatically.

Q: How do I adjust resolution?

A: Your video card/graphic driver and monitor together determine the available resolutions. You can select desired resolution under Window 95/98 with the "Display properties/Settings" control panel

Q: What if I get lost when making monitor adjustments?

A: Simply press the OSD button, then select "Reset" to recall all original settings.

Q: What is the Auto function?

A: The *AUTO adjustment* key restores optimal screen position, phase and clock settings with the press of a single button – without navigation through OSD menus and control keys.

Q: My Monitor has no power (Power LED does not light) ? What should I do?

A: Make sure the DC Jack in the pedestal is connected to the Monitor.

Q: Will the LCD monitor accept an Interlaced signal?

A: No If an Interlace signal is used, the screen displays both odd and even horizontal scanning lines at the same time, distorting the picture.

Q: Does Refresh Rate mean to LCD?

A: Unlike CRT display technology in which the speed the electron beam is swept from the top to the bottom of the screen determines flicker, an active matrix display uses an active element (TFT) to control each individual pixel and thus refresh rate is not really applicable to LCD technology.

Q: Will the LCD screen resistant scratches?

A: A protective coating is applied onto the surface of the LCD, which is durable up to a certain extent of hardness (approximately up to the hardness of a 2H pencil). In general, it is recommended not to expose the panel surface to any excessive shocks or scratches. An optional protective cover with greater scratch resistance is also available.

Q: How should I clean the LCD surface?

A: For normal cleaning, use the clean, soft and fine. For extensive cleaning, please use Isopropyl alcohol. Do not use other solvents such as ethyl alcohol, ethanol, acetone, hexane, etc.

Q: What accessories are available for my 105P / 181AS LCD monitor?

A: Currently there are 3 accessories available for the 150P. There are:

- User installable Protective Cover
 - Optional integrated USB Hub
 - VESA Wall Mount Kit
-

Q: What accessories are available for my 150B / 170B LCD monitor?

A: Currently there are 2 accessories available for the 150B. There are:

- User installable Protective Cover
 - VESA Wall Mount Kit
-

Q: What accessories are available for my 140S LCD monitor?

A: Currently there are 1 accessories available for the 140S. There are:

- VESA Wall Mount Kit
-

Q: How many signal inputs do Philips 150P LCD monitor provide?

A: Standard 15-pin D-Sub and DVI-D connectors and a Macintosh adapter (optional outside of North America) open the 150P up to most PC and workstation users. Handy hot keys on the chin of the 150P make switching between two different video sources a breeze.

Q: Can the Philips LCD Monitor be hung on the wall or used as touch panel?

A: Yes, Philips Brilliance LCD monitors have this optional feature. The standard VESA mount holes on inside removable back cover integrate with a VESA FPMPMI standard arm, which include both a VESA compatible mount bracket and external AC adapter. Touch panels are being developed for future applications. Check with your Philips sales representative for more information.

[RETURN TO TOP OF THE PAGE](#)

Screen Adjustments

Q: What is CustoMax® and what models are compatible? (181AS / 150P)

A: CustoMax® is proprietary Philips software that allows users to adjust monitor via software instead of control keys under Windows base. With the Philips Brilliance 150P, CustoMax® operates via a USB connection to PC. All Philips 150P models are CustoMax® compatible, but your computer must support USB in order to use CustoMax®.

Q: What is the FPadjust program on the setup disk and CD-ROM?

A: The FPadjust program generates alignment patterns that help you adjust monitor settings such as Contrast, Brightness, Horizontal Position, Vertical Position Phase, and Clock for optimal performance.

Q: When I install my monitor, how do I get the best performance for the monitor?

A:

1. For best performance, make sure your display settings are set at 1280x1024@60Hz for 150P / 150B / 140S, 1280x1024@60Hz for 170B / 181AS. Note: You can check the current display settings by pressing the OSD OK button once.
The current display mode is shown in product information in OSD main controls, or under OSD main controls (181AS).
 2. To install the Flat Panel Adjust (FPadjust) program located on the monitor setup disk or CD-ROM, open the setup disk or CD-ROM and double-click the FPadjust.exe icon. This will install FP Adjust automatically and place a shortcut on your desktop.
 3. Run FPadjust by double clicking the shortcut. Follow the instructions step by step to optimize image performance with your system's video controller.
-

Q: How do LCDs compare to CRTs in terms of radiation?

A: Because LCDs do not use an electron gun, they do not generate the same amount of radiation at the screen surface.

Q: What is the screen size enlarge function? (181AS / 170B)

A: User want the best possible display quality regardless of the size of the image. However LCD panel characteristics require some tradeoffs. For example, the 150P highest resolution is 1024x768. In other words, there are 1024x768 or 786,432 pixels on this 15-inch LCD screen. When the monitor needs to display at a lower resolution, say 640x480, the image on the screen is smaller because it requires fewer pixels.

Q: How can I adjust the screen?

A: The screen brightness may be adjusted using the Brightness control in the OSD. Scaling an image in this manner results in slight brightness "fuzziness" or distortion.

[RETURN TO TOP OF THE PAGE](#)

Compatibility with other Peripherals

Q: Can I connect my LCD monitor to any PC, workstation or Mac?

A: Yes, all Philips LCD monitors are fully compatible with standard PC, Mac and workstation. You may need a cable adapter to connect the monitor to your Mac system. Please contact your dealer/reseller for more information.

Q: Are Philips LCD monitors Plug-and-Play?

A: Yes, the monitors are Plug-and-Play compatible with Windows® 95, 98 and the PC98/99 platforms.

Q: What is USB (Universal Serial Bus)?

A: Think of USB as a smart plug for PC peripherals. USB automatically determines resources (like driver software and bus bandwidth) required by peripherals. USB makes necessary resources available without user intervention. There are three main benefits of USB. USB eliminates "case angst," the fear of removing the computer case to install circuit board cards -- that often require adjustment of complicated IRQ settings -- for add-on peripherals. USB does away with "port gridlock." Without USB, PCs are normally limited to one printer, two Com port devices (usually a mouse and modem), one Enhanced Parallel Port add-on (scanner or video camera, for example), and a joystick. More and more peripherals for multimedia computers come on the market every day.

With USB, up to 127 devices can run simultaneously on one computer. USB permits "hot plug-in." No need to shut down, plug in, reboot and run set up to install peripherals. No need to go through the reverse process to unplug a device. Bottom line: USB transforms today's "Plug-and-Pray" into true Plug-and-Play!

Q: What is a USB hub ? (181AS / 150P)

A: A USB hub provides additional connections to the Universal Serial Bus. A hub's upstream port connects a hub to the host, usually a PC. Multiple downstream ports in a hub allows connection to another hub or device, such as a USB keyboard, camera or printer.

[RETURN TO TOP OF THE PAGE](#)

LCD Panel Technology

Q: What is Liquid Crystal Display?

A: A Liquid Crystal Display (LCD) is an optical device that is commonly used to display ASCII characters and images on digital items such as watches, calculators, portable game consoles etc. LCD is the technology used for displays in notebook and other small computers. Like light-emitting diode and gas-plasma technologies, LCD allows displays to be much thinner than cathode ray tube (CRT) technology. LCD consumes much less power than LED and gas-display displays because they work on the principle of blocking light rather than emitting it.

Q: How are LCDs made?

A: LCDs are created from two glass plates separated from each other at a distance of a few microns. Plates are filled with liquid crystal, then seals together. The top plate is colored with a RGB pattern to make the color filter. Then polarizers are glued to both plates. This combination is sometimes called "glass" or "cell." The LCD cell is assembled into a "module" by adding the backlight, driver electronics and frame.

Q: What is polarization ?

A: Polarization is basically directing light to shine in one direction. Light is electromagnetic wave. Electric and magnetic fields oscillate in a direction perpendicular to the propagation of the light beam. The direction of these fields is called "polarization direction." Normal or non-polarized light has fields in several directions; polarized light has a field in only one direction.

Q: What differentiates passive matrix LCDs from active matrix LCDs?

A: An LCD is made with either a passive matrix or an active matrix display grid. An active matrix has a transistor located at each pixel intersection, requiring less current to control the luminance of a pixel. For this reason, the current in an active matrix display can be switched on and off more frequently, improving the screen refresh time (your mouse pointer will appear to move more smoothly across the screen, for example). The passive matrix LCD has a grid of conductors with pixels located at each intersection in the grid.

Q: How does a TFT LCD Panel work?

A: On each column and row of the TFT LCD panel, a data source drive and a gate drive are attached respectively. The TFT drain of each cell is connected to the electrode. The molecular arrangement of liquid crystal elements differs depending on whether it is impressed with voltage or not. It varies the direction of polarized light and the amount of light by letting it through different arrays of liquid crystal elements. When two polarized filters are arranged vertically on a polarized light pole, the light that passes through the upper polarized panel is turned 90 degrees along with spiral structure of the liquid crystal molecules, and goes through the polarized filter at the bottom. When impressed with voltage, liquid crystal molecules are arranged vertically from the original spiral structure and the direction of the light is not turned in 90 degrees. In this case, light that comes through the top polarized panel may not go through the polarized panel at the bottom.

Q: What are the advantages of TFT LCD compared to CRT?

A: In a CRT monitor, a gun shoots electrons and general light by colliding polarized electrons on fluorescent glass. Therefore, CRT monitors basically operate with analog RGB signal. A TFT LCD monitor is a device displaying an input image by operating liquid crystal panel. The TFT has a fundamentally different structure than a CRT: Each cell has an active matrix structure and independent active elements. A TFT LCD has two glass panels and the space between them is filled in with liquid crystal. When each cell is connected with electrodes and impressed with voltage, molecular structure of liquid crystal is altered and controls amount of inlet lighting to display images. A TFT LCD has several advantages over a CRT, since it can be very thin and it does not have flickering because it does not use scanning method.

Q: Vertical frequency of 60Hz optimal for an LCD monitor, why?

A: Unlike a CRT monitor, the TFT LCD panel has a fixed resolution. For example, an XGA monitor has 1024x3 (R, G, B) x 768 pixels and higher resolution may not be available without additional software processing. The panel is designed to optimize display for 65MHz dot clock, one of the standards for XGA displays. Since the vertical/horizontal frequency for this dot clock is 60/48Hz, the optimum frequency for this monitor is 60Hz.

Q: What kind of wide-angle technology is available? How does it work?

A: The TFT LCD panel is an element that controls/displays inlet of a backlight using the dual-refraction of liquid crystal. Using the property that the projection of inlet light refracts toward the major axis of the liquid element, it controls the direction of inlet light and displays it. Since the refraction ratio of inlet light on liquid crystal varies with the inlet angle of the light, the viewing angle of a TFT is much narrower than that of a CRT. Usually, viewing angle refers to the point where the contrast ratio is 10. Many ways to widen the viewing angle are currently being developed; the most commonly used approach is to use a wide viewing angle film, which widens viewing angle by varying the refraction ratio. Also IPS (In Plane Switching) or MVA (Multi Vertical Aligned) is used for wider viewing angle.

Q: Why is there no flicker on an LCD Monitor?

A: Technically speaking, LCDs do flicker, but the cause of the phenomenon is different from that of CRT monitor -- and has no impact of ease of viewing. Flickering in a LCD monitor refers to usually undetectable luminance caused by the difference between positive and negative voltage. On the other hand, CRT flickering that can irritate the human eye comes when the on/off action of the florescent object becomes visible. Since the reaction speed of liquid crystal in a LCD panel is much slower, this troublesome form of flickering is not present in LCD display.

Q: Why is an LCD monitor virtually free of Electro Magnetic Interference?

A: Unlike a CRT, an LCD monitor does not have key parts that generate Electro Magnetic Interference, especially magnetic fields. Also, since LCD display utilizes relatively low power, its power supply is extremely quiet.

[RETURN TO TOP OF THE PAGE](#)

Ergonomics, Ecology, and Safety Standards

Q: What is CE mark?

A: The CE (Conformité Européenne) marking is required to be displayed on the regulated product placed for sale on the European market. This mark "CE" means that a product complies with an applicable European Directive. A European Directive is a European "Law" which relates to health, safety, environment and consumer Protection, much the same as the U.S. National Electrical Code and UL Standards.

Q: Does the LCD monitor conform to general safety standards?

A: Yes. Philips LCD monitors conform to the guidelines of MPR-II and TCO 95-99 standards for the control of radiation, electromagnetic waves, energy reduction, electrical safety in the work environment, and recyclability. The specification page provides detailed safety standards data.

More information is provided in the [Regulatory Information](#) chapter.

Q: Is the Philips LCD Monitor Y2k compliant?

A: Yes, all Philips LCD Monitors are compliant with the Y2K.

[RETURN TO TOP OF THE PAGE](#)

Troubleshooting

[Safety and Troubleshooting](#) • [FAQs](#) • [Common Problems](#) • [Imaging Problems](#) • [Regulatory Information](#) • [Other Related Information](#)

This page presents problems that can be corrected by the user. If the problem still exists after these possible solutions, contact your nearest Philips dealer.

Common Problems

Having this problem?

Check these items

No Picture
(Power LED not lit)

- Make sure the Power cable is plugged to the wall and back of the monitor.
- Make sure the DC power cord has been attached to the DC Jack.
- First, power button in front of the monitor should be in the OFF position, then press it to ON position again.

No Picture
(Power LED is amber or yellow)

- Make sure the computer is turned on.
- Make sure the signal cable is properly connected to your computer.
- Check to see if the monitor cable has bent pins.
- The Energy Saving feature may be activated

Screen says



- Make sure the monitor cable is properly connected to your computer. (Also refer to the Quick Set Up Guide).
- Check to see if the monitor cable has bent pins.
- Make sure the computer is turned on.

AUTO button not working properly

- The Auto Function is designed for use on standard Macintosh or IBM-compatible PC running Microsoft properly Windows.
- It may not work properly if using non-standard PCs or video card.

Imaging Problems

Display position is incorrect

- Push the Auto button.
- Adjust the image position using the Horizontal Position &/or Vertical Position in the second Window

Image vibrates on the screen

- Check that the signal cable is properly connected to the graphics board or PC.

Vertical flicker appears



- Push the Auto button.
- Eliminate the vertical bars using the Clock Adjustment in the first Window

Horizontal flicker appears



- Push the Auto button.
- Eliminate the horizontal bars using the Phase Adjustment in the First Window

The screen is too bright or too dark

- Adjust the contrast and brightness using the First Window. (The backlight of the LCD monitor has a fixed life span. When the screen becomes dark or begins to flicker, please contact your dealer.

An after-image appears

- If an image remains in the screen for an extended period of time, it may be imprinted in the screen and leave an after-image. This usually disappears after a few hours

An after-image remains after the power has been turned off.

- This is characteristic of liquid crystal and is not caused by a malfunction or deterioration of the liquid crystal. The after-image will disappear after a set amount of time

Green, red, blue, dark, and white dots remains

- The remaining dots are normal characteristic of the liquid crystal used in today's technology.

For further assistance, refer to the [Consumer Information Centers](#) list to contact your local Philips distributor.

[RETURN TO TOP OF THE PAGE](#)

Regulatory Information

[TCO'95 Information](#) • [TCO Environmental Requirements](#) • [Energy Star Declaration](#) • [Federal Communications Commission \(FCC\) Notice \(U.S. Only\)](#) • [Commission Federale de la Communication \(FCC Declaration\)](#) • [EN 55022 Compliance \(Czech Republic Only\)](#) • [VCCI Class 2 Notice \(Japan Only\)](#) • [MOC Notice \(South Korea Only\)](#) • [Polish Center for Testing and Certification Notice](#) • [North Europe Information](#) • [BCIQ Notice \(Taiwan Only\)](#) • [Ergonomie Hinweis \(nur Deutschland\)](#) • [Philips End-of-Life Disposal](#) • [Information for UK only](#)

TCO '95 Information

TCO '95: Available on Brilliance 150X.



Congratulations!

You have just purchased a TCO'95 approved and labelled product! Your choice has provided you with a product developed for professional use. Your purchase has also contributed to reducing the burden on the environment and also, to the further development of environmentally adapted electronics products.

Why do we have environmentally labelled computers?

In many countries, environmental labelling has become an established method for encouraging the adaptation of goods and services to the environment. The main problem, as far as computers and other electronics equipment are concerned, is that environmentally harmful substances are used both in the products and during the manufacturing. Since it has not been possible for the majority of electronics equipment to be recycled in a satisfactory way, most of these potentially damaging substances sooner or later enter Nature. There are also other characteristics of a computer, such as energy consumption levels, that are important from the viewpoints of both the work (internal) and natural (external) environments. Since all methods of conventional electricity generation have a negative effect on the environment (acidic and climate-influencing emissions, radioactive waste, etc.), it is vital to conserve energy. Electronics equipment in offices consume an enormous amount of energy since they are often left running continuously.

What does labelling involve?

This product meets the requirements for the TCO'95 scheme which provides for international and environmental labelling of personal computers. The labelling scheme was developed as a joint effort by the TCO (The Swedish Confederation of Professional Employees), Naturskyddsforeningen (The Swedish Society for Nature Conservation) and NUTEK (The National Board for Industrial and Technical Development in Sweden). The requirements cover a wide range of issues: environment, ergonomics, usability, emission of electrical and magnetic fields, energy consumption and electrical and fire safety. The environmental demands concern restrictions on the presence and use of heavy metals, brominated and chlorinated flame retardants, CFCs (freons) and chlorinated solvents, among other things. The product must be prepared for recycling and the manufacturer is obliged to have an environmental plan which must be adhered to in each country where the company implements its operational policy. The energy requirements include a demand that the computer and/or display, after a certain period of inactivity, shall reduce its power consumption to a lower level in one or more stages. The length of time to reactivate the computer shall be reasonable for the user.

Labelled products must meet strict environmental demands, for example, in respect of the reduction of electric and magnetic fields, physical and visual ergonomics and good usability. On the back page of this folder, you will find a brief summary of the environmental requirements met by this product. The complete environmental criteria document may be ordered from:

TCO Development Unit

S-114 94 Stockholm, Sweden

Fax: +46 8 782 92 07

Email (Internet): development@tco.se

Current information regarding TCO'95 approved and labelled products may also be obtained via the Internet, using the address: <http://www.tco-info.com/>

TCO'95 is a co-operative project between TCO (The Swedish Confederation of Professional Employees), Naturskyddsforeningen (The Swedish Society for Nature Conservation) and NUTEK (The National Board for Industrial and Technical Development in Sweden).

Environmental requirements

Brominated flame retardants

Brominated flame retardants are present in printed circuit boards, cables, wires, casings and housings. In turn, they delay the spread of fire. Up to thirty percent of the plastic in a computer casing can consist of flame retardant substances. These are related to another group of environmental toxins, PCBs, which are suspected to give rise to similar harm, including reproductive damage in fish-eating birds and mammals, due to the bio-accumulative * processes. Flame retardants have been found in human blood and researchers fear that disturbances in foetus development may occur.

TCO'95 demand requires that plastic components weighing more than 25 grams must not contain organically bound chlorine and bromine.

Lead **

Lead can be found in picture tubes, display screens, solders and capacitors. Lead damages the nervous system and in higher doses, causes lead poisoning. TCO'95 requirement permits the inclusion of lead since no replacement has yet been developed.

Cadmium**

Cadmium is present in rechargeable batteries and in the colour-generating layers of certain computer displays. Cadmium damages the nervous system and is toxic in high doses. The relevant TCO'99 requirement states that batteries, the colour-generating layers of display screens and the electrical or electronics components must not contain any cadmium.

Mercury**

Mercury is sometimes found in batteries, relays and switches. Mercury damages the nervous system and is toxic in high doses. TCO'95 requirement states that batteries may not contain more than 25 ppm (parts per million) of mercury. It also demands that no mercury is present in any of the electrical or electronics components concerned with the display unit. Mercury is, for the time being, permitted in the back light system of flat panel monitors as there today is no commercially available alternative. TCO aims on removing this exception when a mercury free alternative is available.

CFCs (freons)

CFCs (freons) are sometimes used for washing printed circuit boards and in the manufacturing of expanded foam for packaging. CFCs break down ozone and thereby damage the ozone layer in the stratosphere, causing increased reception on Earth of ultraviolet light with consequent increased risks of skin cancer (malignant melanoma). The relevant TCO'95 requirement: Neither CFCs nor HCFCs may be used during the manufacturing of the product or its packaging.

The TCO'95 requirement: neither CFCs nor HCFCs may be used during the manufacturing of the product or its packaging.

* *Bio-accumulative is defined as substances which accumulate within living organisms*

** *Lead, Cadmium and Mercury are heavy metals which are Bio-accumulative.*

Environmental Requirements

Flame retardants

Flame retardants are present in printed circuit boards, cables, wires, casings and housings. Their purpose is to prevent, or at least to delay the spread of fire. Up to 30% of the plastic in a computer casing can consist of flame retardant substances. Most flame retardants contain bromine or chloride, and those flame retardants are chemically related to another group of environmental toxins, PCBs. Both the flame retardants containing bromine or chloride and the PCBs are suspected of giving rise to severe health effects, including reproductive damage in fish-eating birds and mammals, due to the bio-accumulative* processes. Flame retardants have been found in human blood and researchers fear that disturbances in fetus development may occur.

The relevant TCO'99 demand requires that plastic components weighing more than 25 grams must not contain flame retardants with organically bound bromine or chlorine. Flame retardants are allowed in the printed circuit boards since no substitutes are available.

Cadmium**

Cadmium is present in rechargeable batteries and in the color-generating layers of certain computer displays. Cadmium damages the nervous system and is toxic in high doses. The relevant TCO'99 requirement states that batteries, the color-generating layers of display screens and the electrical or electronics components must not contain any cadmium.

Mercury**

Mercury is sometimes found in batteries, relays and switches. It damages the nervous system and is toxic in high doses. The relevant TCO'99 requirement states that batteries may not contain any mercury. It also demands that mercury is not present in any of the electrical or electronics components associated with the labeled unit.

CFCs (freons)

The relevant TCO'99 requirement states that neither CFCs nor HCFCs may be used during the manufacture and assembly of the product. CFCs (freons) are sometimes used for washing printed circuit boards. CFCs break down ozone and thereby damage the ozone layer in the stratosphere, causing increased reception on earth of ultraviolet light with increased risks e.g. skin cancer (malignant melanoma) as a consequence.

Lead**

Lead can be found in picture tubes, display screens, solders and capacitors. Lead damages the nervous system and in higher doses, causes lead poisoning. The relevant TCO'99 requirement permits the inclusion of lead since no replacement has yet been developed.

* **Bio-accumulative is defined as substances which accumulate within living organisms.**

** **Lead, Cadmium and Mercury are heavy metals which are bio-accumulative.**

[RETURN TO TOP OF THE PAGE](#)

Energy Star Declaration

PHILIPS

150P1*

140S1*

150P1*

180P1*

170B1*

150X1*

This monitor is equipped with a function for saving energy which supports the VESA Display Power Management Signaling (DPMS) standard. This means that the monitor must be connected to a computer which supports VESA DPMS to fulfill the requirements in the NUTEK specification 803299/94. Time settings are adjusted from the system unit by software. From indicated inactivity to Power Saving Position A2, the total time must not be set to more than 70 minutes.

| NUTEK | VESA State | LED Indicator | Power Consumption |
|------------------|------------|---------------|-------------------|
| Normal operation | ON | Green | < 23 W |

Power Saving
Position A1

Suspend Amber < 5 W

Power Saving
Position A2

OFF Amber < 3 W



As an ENERGY STAR® Partner, PHILIPS has determined that this product meets the ENERGY STAR® guidelines for energy efficiency.



We recommend you switch off the monitor when it is not in use for quite a long time.

[RETURN TO TOP OF THE PAGE](#)

Federal Communications Commission (FCC) Notice (U.S. Only)



This equipment has been tested and found to comply with the limits for a Class B digital device, pursuant to Part 15 of the FCC Rules. These limits are designed to provide reasonable protection against harmful interference in a residential installation. This equipment generates, uses and can radiate radio frequency energy and, if not installed and used in accordance with the instructions, may cause harmful interference to radio communications. However, there is no guarantee that interference will not occur in a particular installation. If this equipment does cause harmful interference to radio or television reception, which can be determined by turning the equipment off and on, the user is encouraged to try to correct the interference by one or more of the following measures:

- Reorient or relocate the receiving antenna.
- Increase the separation between the equipment and receiver.
- Connect the equipment into an outlet on a circuit different from that to which the receiver is connected.
- Consult the dealer or an experienced radio/TV technician for help.



Changes or modifications not expressly approved by the party responsible for compliance could void the user's authority to operate the equipment.

Use only RF shielded cable that was supplied with the monitor when connecting this monitor to a computer device.

To prevent damage which may result in fire or shock hazard, do not expose this appliance to rain or excessive moisture.

THIS CLASS B DIGITAL APPARATUS MEETS ALL REQUIREMENTS OF THE CANADIAN INTERFERENCE-CAUSING EQUIPMENT REGULATIONS.

[RETURN TO TOP OF THE PAGE](#)

Commission Federale de la Communication (FCC Declaration)



Cet équipement a été testé et déclaré conforme aux limites des appareils numériques de class B, aux termes de l'article 15 Des règles de la FCC. Ces limites sont conçues de façon à fournir une protection raisonnable contre les interférences nuisibles dans le cadre d'une installation résidentielle. CET appareil produit, utilise et peut émettre des hyperfréquences qui, si l'appareil n'est pas installé et utilisé selon les consignes données, peuvent causer des interférences nuisibles aux communications radio. Cependant, rien ne peut garantir l'absence d'interférences dans le cadre d'une installation particulière. Si cet appareil est la cause d'interférences nuisibles pour la réception des signaux de radio ou de télévision, ce qui peut être décelé en fermant l'équipement, puis en le remettant en fonction, l'utilisateur pourrait essayer de corriger la situation en prenant les mesures suivantes:

- Réorienter ou déplacer l'antenne de réception.
- Augmenter la distance entre l'équipement et le récepteur.
- Brancher l'équipement sur un autre circuit que celui utilisé par le récepteur.
- Demander l'aide du marchand ou d'un technicien chevronné en radio/télévision.



Toutes modifications n'ayant pas reçu l'approbation des services compétents en matière de conformité est susceptible d'interdire à l'utilisateur l'usage du présent équipement.

N'utiliser que des câbles RF armés pour les connections avec des ordinateurs ou périphériques.

CET APPAREIL NUMERIQUE DE LA CLASSE B RESPECTE TOUTES LES EXIGENCES DU REGLEMENT SUR LE MATERIEL BROUILLEUR DU CANADA.

[RETURN TO TOP OF THE PAGE](#)

EN 55022 Compliance (Czech Republic Only)

This device belongs to category B devices as described in EN 55022, unless it is specifically stated that it is a Class A device on the specification label. The following applies to devices in Class A of EN 55022 (radius of protection up to 30 meters). The user of the device is obliged to take all steps necessary to remove sources of interference to telecommunication or other devices.

Pokud není na typovém štítku počítače uvedeno, že spadá do do třídy A podle EN 55022, spadá automaticky do třídy B podle EN 55022. Pro zařízení zařazená do třídy A (chranné pásmo 30m) podle EN 55022 platí následující. Dojde-li k rušení telekomunikačních nebo jiných zařízení je uživatel povinen provést taková opatření, aby rušení odstranil.

[RETURN TO TOP OF THE PAGE](#)

VCCI Notice (Japan Only)

This is a Class B product based on the standard of the Voluntary Control Council for Interference (VCCI) for Information technology equipment. If this equipment is used near a radio or television receiver in a domestic environment, it may cause radio Interference. Install and use the equipment according to the instruction manual.

Class B ITE



この装置は、情報処理装置等電波障害自主規制協議会 (VCCI) の基準に基づくクラス B 情報技術装置です。この装置は家庭環境で使用することを目的としていますが、この装置がラジオやテレビジョン受信機に近接して使用されると、受信障害を引き起こすことがあります。取扱説明書に従って正しい取り扱いをして下さい。

[RETURN TO TOP OF THE PAGE](#)

MOC Notice (South Korea Only)

Class B Device

| 장치 종류 | 사용자 안내문 |
|-------|---|
| B급 기기 | 이 장치는 가정용으로 전자파 적합등록을 한 장치로서 주거지역에서는 물론 모든 지역에서 사용할 수 있습니다. |



Please note that this device has been approved for non-business purposes and may be used in any environment, including residential areas.

Polish Center for Testing and Certification Notice

The equipment should draw power from a socket with an attached protection circuit (a three-prong socket). All equipment that works together (computer, monitor, printer, and so on) should have the same power supply source.

The phasing conductor of the room's electrical installation should have a reserve short-circuit protection device in the form of a fuse with a nominal value no larger than 16 amperes (A).

To completely switch off the equipment, the power supply cable must be removed from the power supply socket, which should be located near the equipment and easily accessible.

A protection mark "B" confirms that the equipment is in compliance with the protection usage requirements of standards PN-93/T-42107 and PN-89/E-06251.

Wymagania Polskiego Centrum Badań i Certyfikacji

Urządzenie powinno być zasilane z gniazda z przyłączonym obwodem ochronnym (gniazdo z kołkiem). Współpracujące ze sobą urządzenia (komputer, monitor, drukarka) powinny być zasilane z tego samego źródła.

Instalacja elektryczna pomieszczenia powinna zawierać w przewodzie fazowym rezerwową ochronę przed zwarciami, w postaci bezpiecznika o wartości znamionowej nie większej niż 16A (amperów).

W celu całkowitego wyłączenia urządzenia z sieci zasilania, należy wyjąć wtyczkę kabla zasilającego z gniazda, które powinno znajdować się w pobliżu urządzenia i być łatwo dostępne.

Znak bezpieczeństwa "B" potwierdza zgodność urządzenia z wymaganiami bezpieczeństwa użytkowania zawartymi w PN-93/T-42107 i PN-89/E-06251.

Pozostałe instrukcje bezpieczeństwa

- Nie należy używać wtyczek adapterowych lub usuwać kołka obwodu ochronnego z wtyczki. Jeżeli konieczne jest użycie przedłużacza to należy użyć przedłużacza 3-żyłowego z prawidłowo połączonym przewodem ochronnym.
- System komputerowy należy zabezpieczyć przed nagłymi, chwilowymi wzrostami lub spadkami napięcia, używając eliminatora przepięć, urządzenia dopasowującego lub bezzakłócenowego źródła zasilania.
- Należy upewnić się, aby nic nie leżało na kablach systemu komputerowego, oraz aby kable nie były umieszczone w miejscu, gdzie można byłoby na nie nadeptywać lub potykać się o nie.
- Nie należy rozlewać napojów ani innych płynów na system komputerowy.
- Nie należy wpychać żadnych przedmiotów do otworów systemu komputerowego, gdyż może to spowodować pożar lub porażenie prądem, poprzez zwarcie elementów wewnętrznych.
- System komputerowy powinien znajdować się z dala od grzejników i źródeł ciepła. Ponadto, nie należy blokować otworów wentylacyjnych. Należy unikać kładzenia luźnych papierów pod komputer oraz umieszczania komputera w ciasnym miejscu bez możliwości cyrkulacji powietrza wokół niego.

North Europe Information

Placering/Ventilation

VARNING:

FÖRSÄKRA DIG OM ATT HUVUDBRYTARE OCH UTTAG ÄR LÄTÅTKOMLIGA, NÄR DU STÄLLER DIN UTRUSTNING PÅPLATS.

Placering/Ventilation

ADVARSEL:

SØRG VED PLACERINGEN FOR, AT NETLEDNINGENS STIK OG STIKKONTAKT ER NEMT TILGÆNGELIGE.

Paikka/Ilmankierto

VAROITUS:

SIJOITA LAITE SITEN, ETTÄ VERKKOJOHTO VOIDAAN TARVITTAESSA HELPOSTI IRROTTAA PISTORASIESTA.

Plassering/Ventilasjon

ADVARSEL:

NÅR DETTE UTSTYRET PLASSERES, MÅ DU PASSE PÅ AT KONTAKTENE FOR STØMTILFØRSEL ER LETTE Å NÅ.

[RETURN TO TOP OF THE PAGE](#)

BCIQ Notice (Taiwan Only)



[RETURN TO TOP OF THE PAGE](#)

Ergonomie Hinweis (nur Deutschland)

Der von uns gelieferte Farbmonitor entspricht den in der "Verordnung über den Schutz vor Schäden durch Röntgenstrahlen" festgelegten Vorschriften.

Auf der Rückwand des Gerätes befindet sich ein Aufkleber, der auf die Unbedenklichkeit der Inbetriebnahme hinweist, da die Vorschriften über die Bauart von Störstrahlern nach Anlage III § 5 Abs. 4 der Röntgenverordnung erfüllt sind.

Damit Ihr Monitor immer den in der Zulassung geforderten Werten entspricht, ist darauf zu achten, daß

1. Reparaturen nur durch Fachpersonal durchgeführt werden.
2. nur original-Ersatzteile verwendet werden.
3. bei Ersatz der Bildröhre nur eine bauartgleiche eingebaut wird.

Aus ergonomischen Gründen wird empfohlen, die Grundfarben Blau und Rot nicht auf dunklem Untergrund zu verwenden (schlechte Lesbarkeit und erhöhte Augenbelastung bei zu geringem Zeichenkontrast wären die Folge).

Der arbeitsplatzbezogene Schalldruckpegel nach DIN 45 635 beträgt 70dB (A) oder weniger.



ACHTUNG: BEIM AUFSTELLEN DIESES GERÄTES DARAUFGAHTEN, DAß NETZSTECKER UND NETZKABELANSCHLUß LEICHT ZUGÄNGLICH SIND.

[RETURN TO TOP OF THE PAGE](#)

End-of-Life Disposal

Your new monitor contains materials that can be recycled and reused. Specialized companies can recycle your product to increase the amount of reusable materials and to minimize the amount to be disposed of.

Please find out about the local regulations on how to dispose of your old monitor from your local Philips dealer.

[RETURN TO TOP OF THE PAGE](#)

Information for UK only

WARNING - THIS APPLIANCE MUST BE EARTHED.

Important:

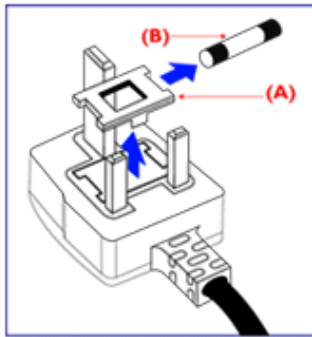

This apparatus is supplied with an approved moulded 13A plug. To change a fuse in this type of plug proceed as follows:

1. Remove fuse cover and fuse.
2. Fit new fuse which should be a BS 1362 5A, A.S.T.A. or BSI approved type.
3. Refit the fuse cover.

If the fitted plug is not suitable for your socket outlets, it should be cut off and an appropriate 3-pin plug fitted in its place.

If the mains plug contains a fuse, this should have a value of 5A. If a plug without a fuse is used, the fuse at the distribution board should not be greater than 5A.

Note: The severed plug must be destroyed to avoid a possible shock hazard should it be inserted into a 13A socket elsewhere.

How to connect a plug

The wires in the mains lead are coloured in accordance with the following code:

BLUE - "NEUTRAL" ("N")

BROWN - "LIVE" ("L")

GREEN & YELLOW - "EARTH" ("E")

1. The GREEN AND YELLOW wire must be connected to the terminal in the plug which is marked with the letter "E" or by the Earth symbol  or coloured GREEN or GREEN AND YELLOW.

2. The BLUE wire must be connected to the terminal which is marked with the letter "N" or coloured BLACK.

3. The BROWN wire must be connected to the terminal which marked with the letter "L" or coloured RED.

Before replacing the plug cover, make certain that the cord grip is clamped over the sheath of the lead - not simply over the three wires.

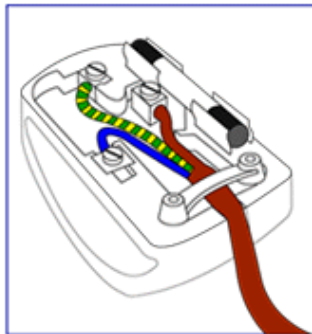

[RETURN TO TOP OF THE PAGE](#)

Other Related Information

[Safety and Troubleshooting](#) • [FAQs](#) • [Troubleshooting](#) • [Regulatory Information](#) • [Information for Users in the U. S.](#) • [Information for Users Outside the U.S](#)

Information for Users in the U. S.

For units set at 115 V :

Use a UL Listed Cord Set consisting of a minimum 18 AWG, Type SVT or SJT three conductor cord a maximum of 15-feet long and a parallel blade, grounding type attachment plug rated 15 A, 125 V.

For units set at 230 V:

Use a UL Listed Cord Set consisting of a minimum 18 AWG, Type SVT or SJT three conductor cord a maximum of 15-feet long and a tandem blade, grounding type attachment plug rated 15 A, 250 V.

Information for Users outside the U.S.

For units set at 230 V:

Use a Cord Set consisting of a minimum 18 AWG cord and grounding type attachment plug rated 15 A, 250 V. The Cord Set should have the appropriate safety approvals for the country in which the equipment will be installed and / or be marked HAR.

[RETURN TO TOP OF THE PAGE](#)

Philips Pixel Defect Policy

[Product Features](#) • [Technical Specifications](#) • [Resolution & Preset Modes](#) • [Automatic Power Saving](#) • [Physical Specification](#) • [Pin Assignment](#) • [Product Views](#)

Philips' Flat Panel Monitors Pixel Defect Policy

Philips strives to deliver the highest quality products. We use some of the industry's most advanced manufacturing processes and practice stringent quality control. However, pixel or subpixel defects on the TFT LCD panels used in flat panel monitors are sometimes unavoidable. No manufacturer can guarantee that all panels will be free from pixel defects, but Philips guarantees that any monitor with an unacceptable number of defects will be repaired or replaced under warranty. This notice explains the different types of pixel defects and defines acceptable defect levels for each type. In order to qualify for repair or replacement under warranty, the number of pixel defects on a TFT LCD panel must exceed these acceptable levels. For example, no more than 0.0004% of the subpixels on a 15" XGA monitor may be defective. Additionally, because some types or combinations of pixel defects are more noticeable than others, Philips sets even higher quality standards for those.

Pixels and Subpixels

A pixel, or picture element, is composed of three subpixels in the primary colors of red, green and blue. Many pixels together form an image. When all subpixels of a pixel are lit, the three colored subpixels together appear as a single white pixel. When all are dark, the three colored subpixels together appear as a single black pixel. Other combinations of lit and dark subpixels appear as single pixels of other colors.

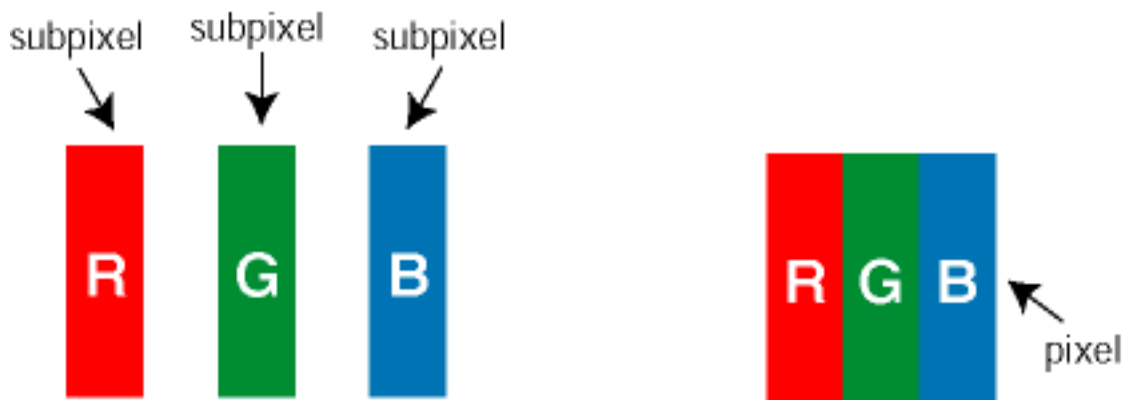

Types of Pixel Defects

Pixel and subpixel defects appear on the screen in different ways. There are two categories of pixel defects and several types of subpixel defects within each category.

Bright Dot Defects Bright dot defects appear as pixels or subpixels that are always lit or "on". These are the types of bright dot defects:

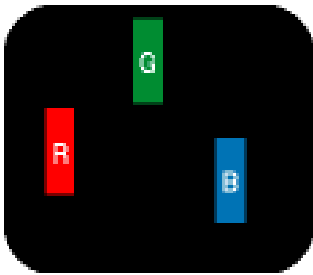

One lit red, green or blue subpixel

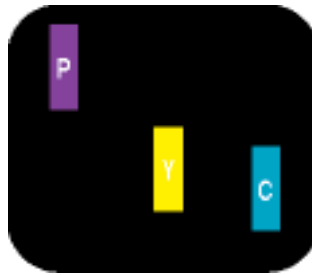

Two adjacent lit subpixels:
- Red + Blue = Purple
- Red + Green = Yellow
- Green + Blue = Cyan (Light Blue)



Three adjacent lit subpixels (one white pixel)

Black Dot Defects Black dot defects appear as pixels or subpixels that are always dark or "off". These are the types of black dot defects:

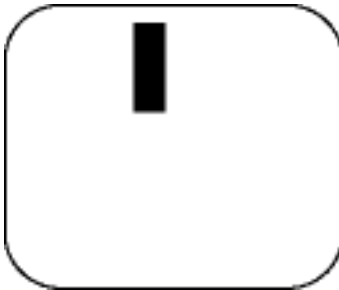

One dark subpixel

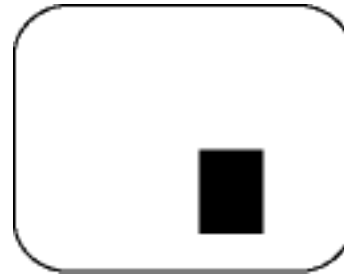

Two or three adjacent dark subpixels

Proximity of Pixel Defects

Because pixel and subpixels defects of the same type that are nearby one another may be more noticeable, Philips also specifies tolerances for the proximity of pixel defects.

Pixel Defect Tolerances

In order to qualify for repair or replacement due to pixel defects during the warranty period, a TFT LCD panel in a Philips flat panel monitor must have pixel or subpixel defects exceeding the tolerances listed in the following tables.

| BRIGHT DOT DEFECTS | ACCEPTABLE LEVEL | | | | |
|--|-------------------------|---------------|------------------------|-------------------------|---------------|
| <i>MODEL</i> | 140S | 150B | 150P & 150X | 180P & 181AS | 170B |
| 1 lit subpixel | 10 or fewer | 10 or fewer | 6 or fewer | 10 or fewer | 10 or fewer |
| 2 adjacent lit subpixels | 3 or fewer | 3 or fewer | 2 or fewer | 3 or fewer | 3 or fewer |
| 3 adjacent lit subpixels (one white pixel) | None | None | None | None | None |
| Distance between two bright dot defects* | 12 mm or more | 12 mm or more | 14 mm or more | 14 mm or more | 14 mm or more |
| Bright dot defects within 20 mm circle | 6 or fewer | 6 or fewer | 4 or fewer | 4 or fewer | 4 or fewer |
| Total bright dot defects of all types | 10 or fewer | 10 or fewer | 6 or fewer | 10 or fewer | 10 or fewer |

| BLACK DOT DEFECTS | ACCEPTABLE LEVEL | | | | |
|---|-------------------------|--------------|------------------------|-------------------------|---------------|
| <i>MODEL</i> | 140S | 150B | 150P & 150X | 180P & 181AS | 170B |
| 1 dark subpixel | 10 or fewer | 10 or fewer | 6 or fewer | 10 or fewer | 10 or fewer |
| 2 adjacent dark subpixels | 3 or fewer | 3 or fewer | 1 or fewer | 2 or fewer | 2 or fewer |
| 3 adjacent dark subpixels | None | None | None | 1 or fewer | None |
| Distance between two black dot defects* | 4 mm or more | 4 mm or more | 4 mm or more | 14 mm or more | 14 mm or more |
| Black dot defects within 20 mm circle* | 6 or fewer | 6 or fewer | 4 or fewer | 5 or fewer | 5 or fewer |
| Total black dot defects of all types | 10 or fewer | 10 or fewer | 6 or fewer | 15 or fewer | 15 or fewer |

| TOTAL DOT DEFECTS | ACCEPTABLE LEVEL | | | | |
|--|-------------------------|-------------|------------------------|-------------------------|-------------|
| <i>MODEL</i> | 140S | 150B | 150P & 150X | 180P & 181AS | 170B |
| Total bright or black dot defects of all types | 12 or fewer | 12 or fewer | 10 or fewer | 15 or fewer | 10 or fewer |

Note: 1 or 2 adjacent subpixel defects = 1 dot defect

[RETURN TO TOP OF THE PAGE](#)

Connecting to Your PC

Your LCD Monitor : [Front View Product Description](#) • [Accessory Pack](#) • [Connecting to Your PC](#) • [Getting Started](#) • [Optimizing Performance](#)

Accessory Pack

Unpack all the parts.

1) Audio in Cable (lime)

2) Microphone out Cable (pink)

3) Power Cable (socket may differ for different countries)

4) Macintosh Adapter (optional)

5) DVI-D adapter

6) VGA adapter

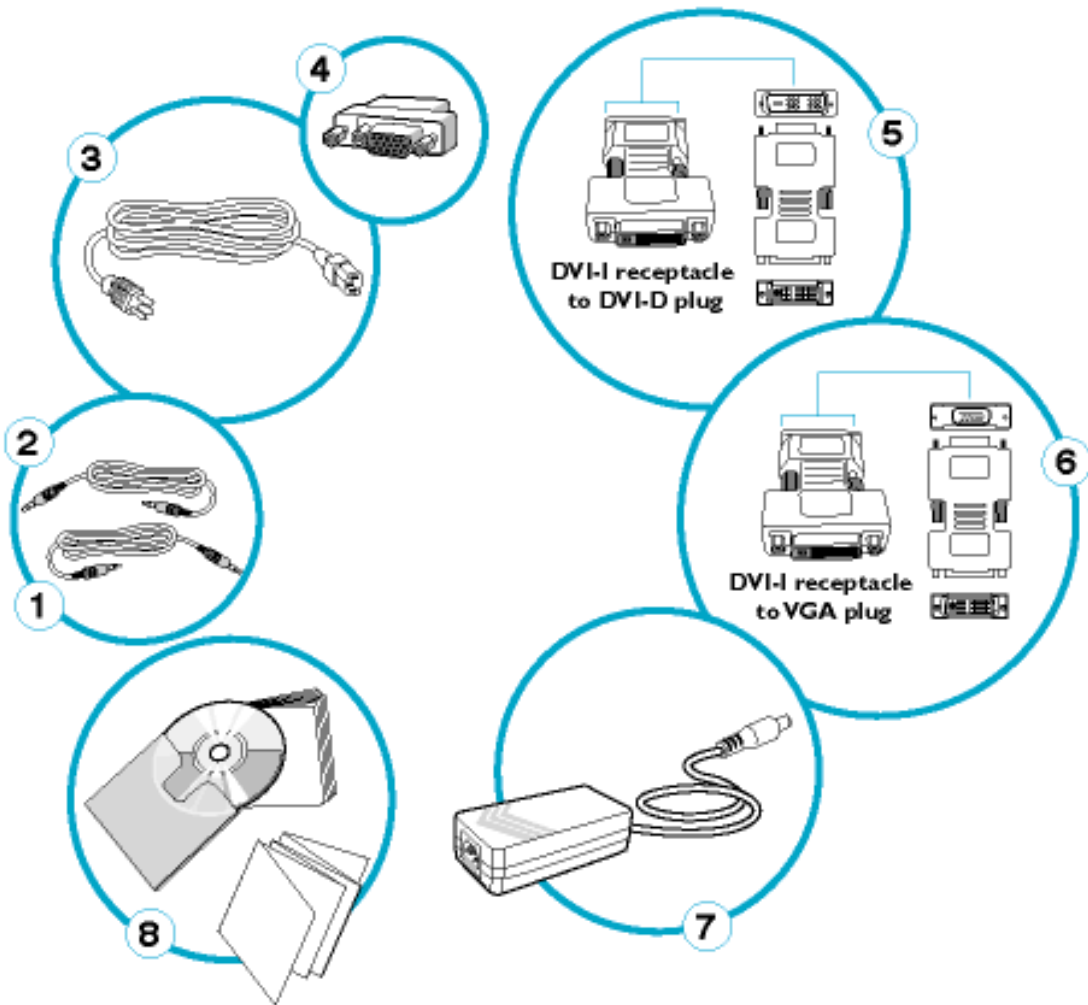

7) AC/DC adapter

8) E-DFU package (Quick Setup guide, Using Your Monitor Manual, and CD-ROM)

[RETURN TO TOP OF THE PAGE](#)

Connecting to Your PC

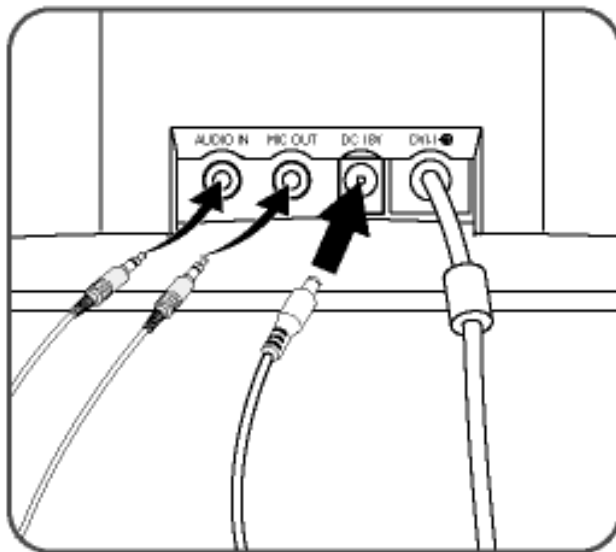

1) Plug DC power cord into DC inlet. Also connect audio and microphone cable.

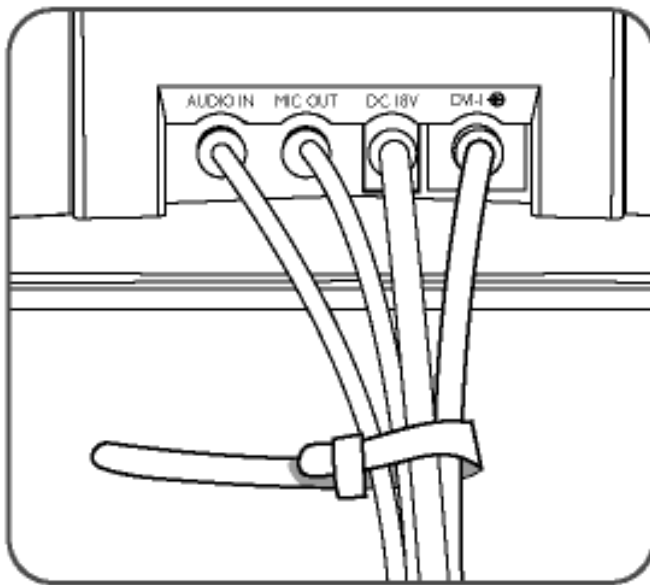

2) Tie cables with cable tie which attached on the flying DVI-I cable.

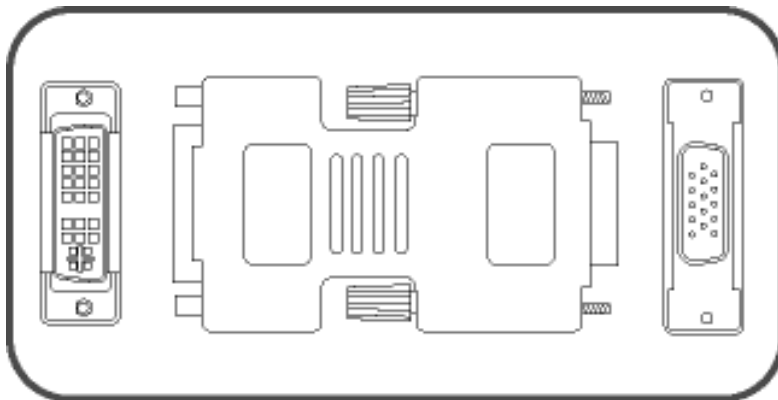

**DVI-I receptacle to
VGA plug**

NOTE 1: If your computer only provides a VGA connector for video output, you need to connect the VGA adaptor to the end of the Monitor signal cable.

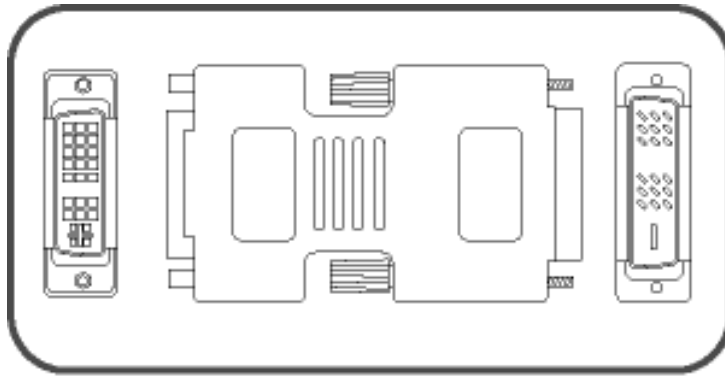

DVI-I receptacle to DVI-D plug

NOTE 2: If your computer provides a DVI-D connector for signal output, you need to connect the special DVI-D adaptor to the end of the Monitor signal cable.

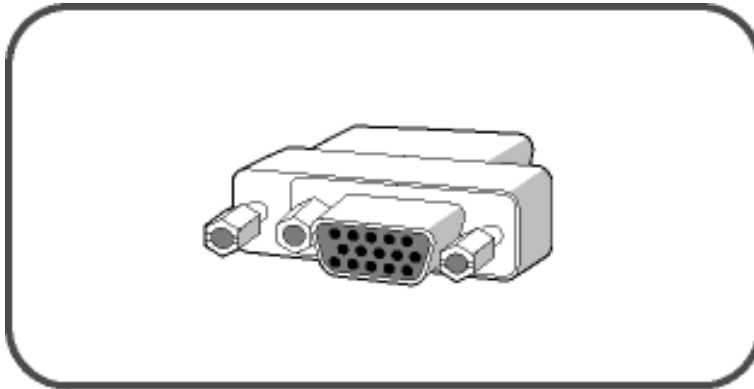

Mac adapter

NOTE 3: If you use an Apple Macintosh™, you need to connect the special Mac adapter to one end of the monitor signal cable.

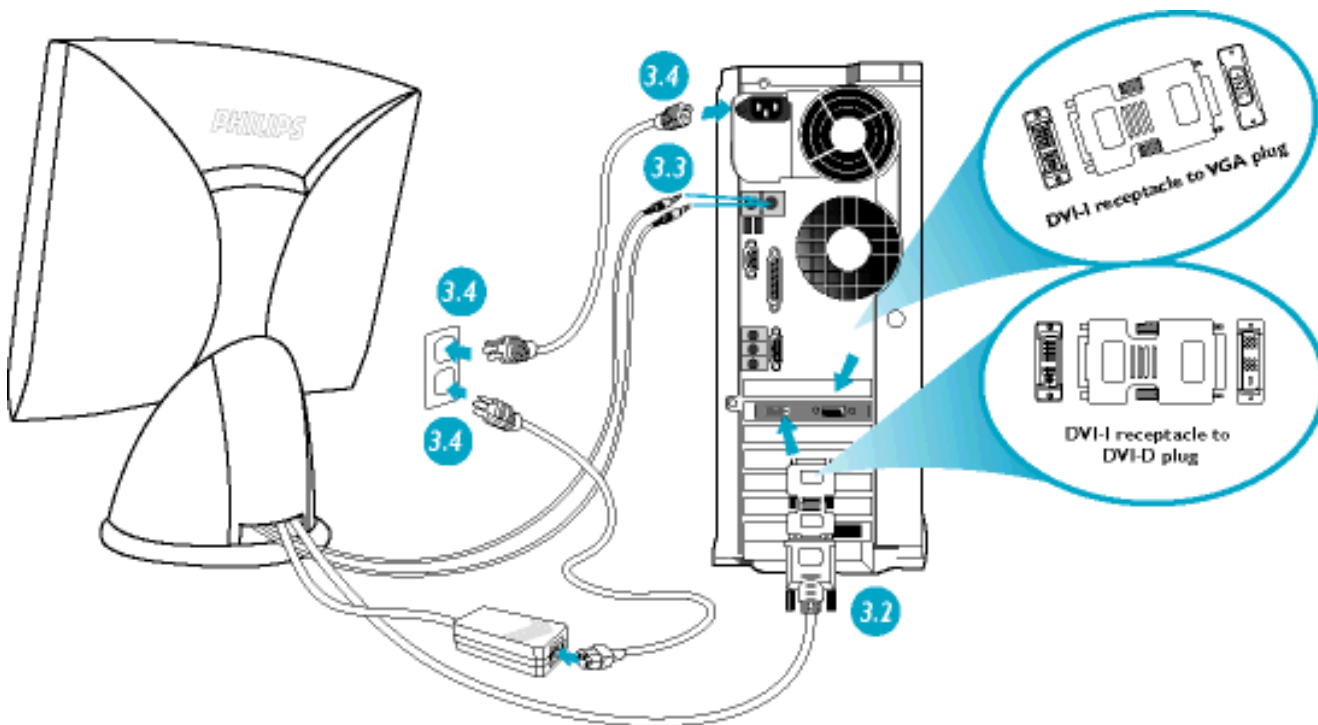

3) Connect to Your PC

3.1 Turn off your computer and unplug its power cable.

3.2 Connect the monitor signal cable to the video connector on the back of your computer.

3.3 Connect the audio, microphone to the ports on the back of your computer, if any.

3.4 Plug the power cord of your computer and your monitor into a nearby outlet.

3.5 Turn on your computer and monitor. If the monitor displays an image, installation is complete. If your monitor displays the image "Cannot Display This Video Mode", please refer to Getting Started 1.3.

[RETURN TO TOP OF THE PAGE](#)

Getting Started

Your LCD Monitor : [Front View Product Description](#) • [Connecting to Your PC](#) • [Getting Started](#) • [Optimizing Performance](#)

Getting Started

1.1 First turn on your monitor and other peripherals if any, then turn on your computer.

1.2 If your monitor displays an image and Windows prompts you for an .inf file or driver disk, please go to step 1.4.

1.3 If your monitor displays the message "Cannot Display This Video Mode", please follow the procedure below to set your computer for the recommended video mode: 1024 x 768 @ 60Hz (for 14", 15") or 1280x1024, 60Hz (for 17", 18")

1.3.1 Unplug all cables.

1.3.2 Connect your PC to the monitor that you used previously and which displayed correctly.

1.3.3 In the Windows Start Menu, select Settings --> Control Panel. In the Control Panel Window, select the Display icon. Inside the Display Control Panel, select the "Settings" tab. Under the Settings Tab, in box labeled "desktop area", move the sidebar to 1024x768 pixels (for 14", 15") or 1280x1024 pixels (for 17", 18"). Open "Advanced Properties" and set the Refresh Rate to 60Hz, then click OK.

1.3.4 Restart your computer and repeat step 1.3.3 to verify that your PC is set at 1024x768, 60Hz (for 14", 15") or 1280x1024, 60Hz (for 17", 18").

1.3.5 Shut down your computer, disconnect your old monitor and reconnect your Philips LCD monitor.

1.3.6 Turn on your monitor and then turn on your PC.

1.4 Your computer may ask you for monitor drivers (.inf and .icm files) or a driver disk. Follow the instructions to insert the CD-ROM included in this package, and the monitor drivers (.inf and .icm files) will be installed automatically.

[RETURN TO TOP OF THE PAGE](#)

The OSD Controls

[Description of the On-Screen Display](#) • [The OSD Tree](#)

The OSD Controls : [Brightness \(HotKey\)](#) • [Language](#) • [Adjust Position](#) • [Brightness and Contrast](#) • [Video Noise](#) • [Adjust Color](#) • [OSD Settings](#) • [Product Information](#) • [Reset to Factory Settings](#) • [Input Selection](#) • [Close Main Controls](#)



BRIGHTNESS

Brightness is the overall intensity of the light coming from the screen. To adjust your screen's brightness, follow the steps below. An 80% brightness is recommended.

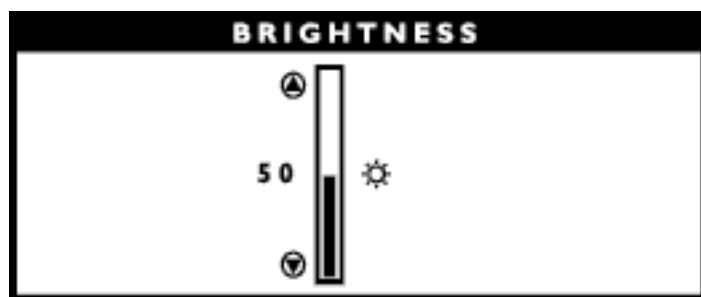
1) Press the  or  button on the monitor. The BRIGHTNESS window appears.



2) Press the button to adjust the brightness.

3) When the brightness is adjusted to the level desired, stop pressing the  or  button and after three seconds the BRIGHTNESS window will disappear with the new adjustment saved.



Smart
Help

After the BRIGHTNESS window has disappeared...

... to continue to the CONTRAST window by pressing the  key, an OSD MAIN CONTROLS window will appear



... to continue to the MAIN CONTROLS, follow the steps under VOLUME.

Note: You can also adjust the brightness from the MAIN CONTROLS window. See BRIGHTNESS & CONTRAST for details.

[RETURN TO TOP OF THE PAGE](#)



LANGUAGE

The ON SCREEN DISPLAY prompts can be in one of six languages. The default language is English, but you can select French, Spanish, German, Italian, or Japanese.

1) Press the  button on the monitor. The MAIN CONTROLS window appears. LANGUAGE is highlighted. (If not, press the  or  button on the monitor until LANGUAGE is highlighted)

2) Press the  button again. The LANGUAGE window appears.



3) Press the  or  button until the desired language is highlighted.



4) Press the  button to confirm your selection and return to MAIN CONTROLS window. CLOSE MAIN CONTROLS is highlighted.



Smart Help

After returning to MAIN CONTROLS...

Smart Help

... to continue to ADJUST POSITION, press the  button until ADJUST POSITION is highlighted. Next, follow steps 3 - 6 under ADJUST POSITION.

... to exit completely, press the .

[RETURN TO TOP OF THE PAGE](#)

ADJUST POSITION

ADJUST POSITION is composed of two steps, ADJUST HORIZONTAL and ADJUST VERTICAL.

ADJUST HORIZONTAL shifts the image on your screen either left or right. Use this feature if your image does not appear centered in relation to the sides of your screen.

ADJUST VERTICAL shifts the image on your screen either up or down. Use this feature if your image does not appear centered in relation to the top and bottom of your screen.



1) Press the  button on the monitor. The MAIN CONTROLS window appears. LANGUAGE is highlighted.



2) Press the  button until ADJUST POSITION is highlighted.

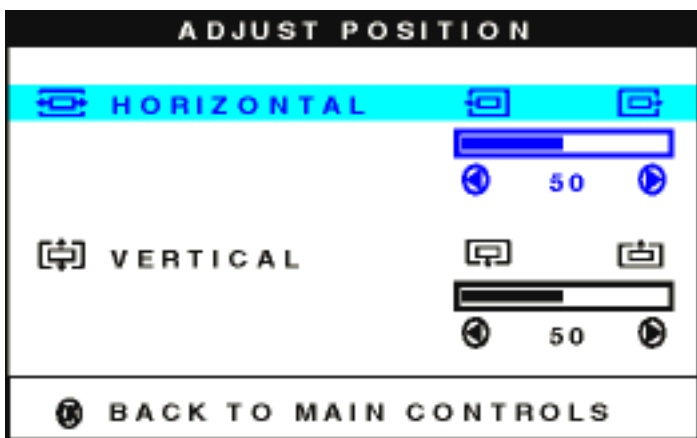



3) Press the  button. The ADJUST POSITION window appears. ADJUST HORIZONTAL is highlighted.

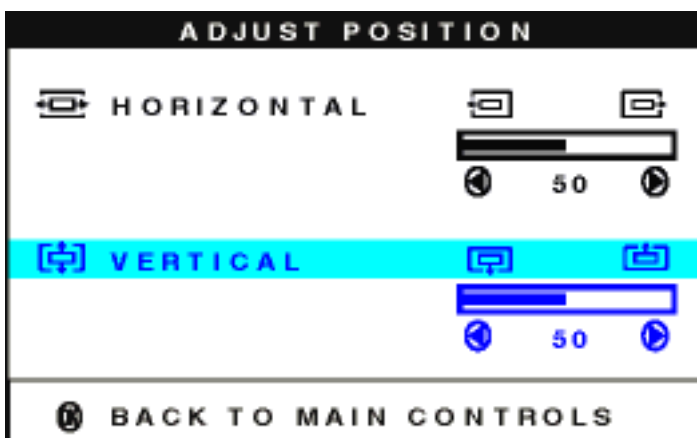

4) Press the  or  button to move the image left or right until it appears centered.

5) Press the  button until ADJUST VERTICAL is highlighted. Press the  or  button to move the image up or down until it appears centered.



6) Press the  button to confirm your selections and return to the MAIN CONTROLS window. CLOSE MAIN CONTROLS is highlighted.



Smart Help

After returning to MAIN CONTROLS...

Smart
Help

... to continue to BRIGHTNESS & CONTRAST, press the  button until BRIGHTNESS & CONTRAST is highlighted. Next, follow steps 3 - 6 under BRIGHTNESS & CONTRAST.

... to exit completely, press the  button.

[RETURN TO TOP OF THE PAGE](#)

BRIGHTNESS & CONTRAST

BRIGHTNESS & CONTRAST is composed of two steps, BRIGHTNESS and CONTRAST. Brightness is the overall intensity of the light coming from the screen. An 80% brightness is recommended. Contrast is the difference between the light and dark areas on the screen. A 100% contrast is recommended.

To adjust the Brightness and Contrast, follow the steps below. Note: Brightness can also be adjusted without using the MAIN CONTROLS window. See the steps at the beginning of these instructions to learn how.



1) Press the  button on the monitor. The MAIN CONTROLS window appears. LANGUAGE is highlighted.



2) Press the  button until BRIGHTNESS & CONTRAST is highlighted.

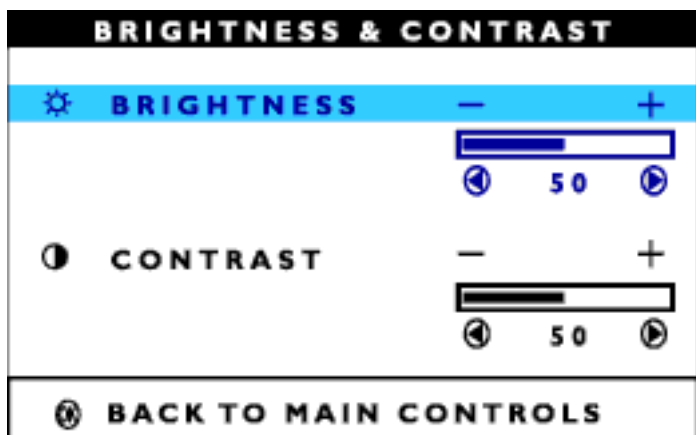



3) Press the  button. The BRIGHTNESS & CONTRAST window appears. BRIGHTNESS is highlighted.

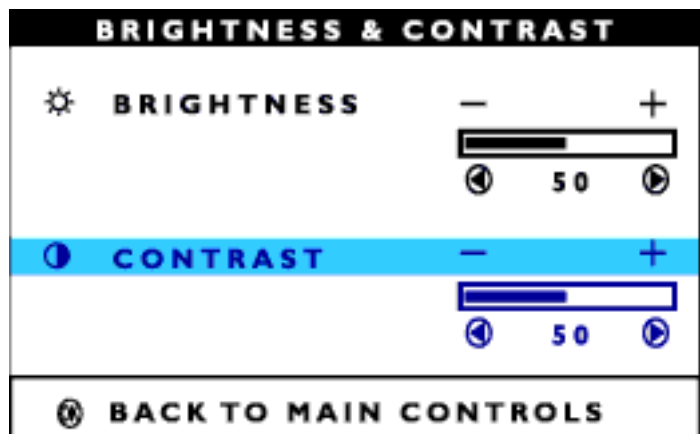

4) Press the  or  button to adjust the brightness. An 80% brightness is recommended.

5) When finished with BRIGHTNESS, press the  button until CONTRAST is highlighted. Next, press the  or  button to adjust the contrast. A 100% contrast is recommended.



6) Press the  button to confirm your selection and return to the MAIN CONTROLS window. CLOSE MAIN CONTROLS is highlighted.



Smart Help

After returning to MAIN CONTROLS...

Smart
Help

... to continue to VIDEO NOISE, press the  button until VIDEO NOISE is highlighted. Next, follow steps 3 - 6 under VIDEO NOISE. (Note: VIDEO NOISE is not available on all monitors. If not on your MAIN CONTROLS window, continue on to OSD SETTINGS.)

... to exit completely, press the  button.

[RETURN TO TOP OF THE PAGE](#)

VIDEO NOISE *(not available on all monitors)*

VIDEO NOISE is composed of two steps, PHASE and CLOCK. PHASE adjustment reduces the horizontal flicker of characters on the screen. CLOCK adjustment reduces the vertical flicker of characters on the screen.

To adjust Phase and Clock, follow the steps below. If VIDEO NOISE is not available on your monitor, continue on to OSD SETTINGS. Note: Before adjusting VIDEO NOISE yourself, press the AUTO button on the front panel. If there is no improvement, then return to adjust PHASE and CLOCK.

1) Press the  button on the monitor. The MAIN CONTROLS window appears. LANGUAGE is highlighted.



2) Press the  button until VIDEO NOISE is highlighted.



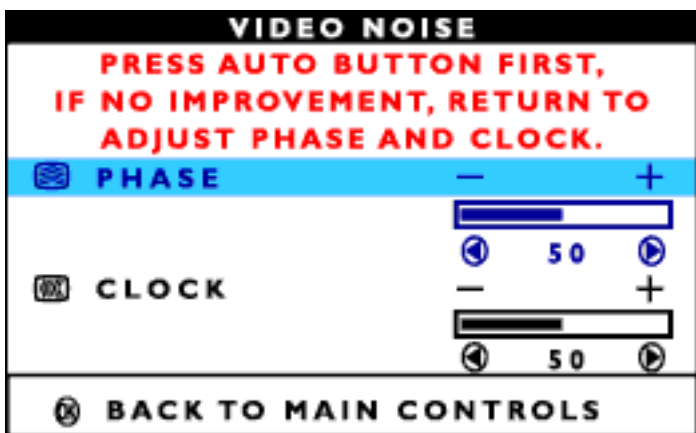

3) Press the  button. The VIDEO NOISE window appears. PHASE is highlighted.

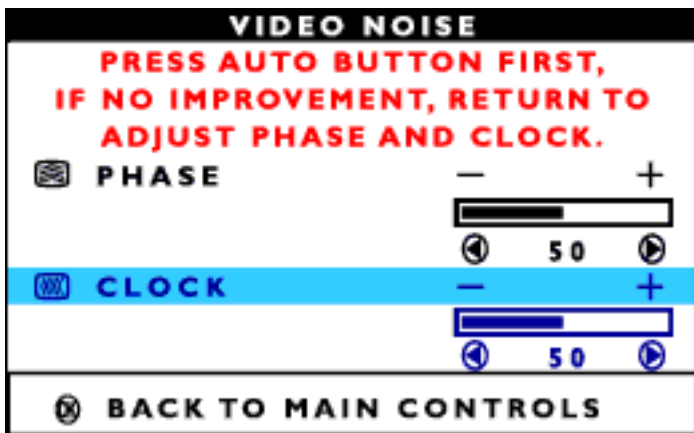

4) Press the  or  button to adjust the phase.

5) When finished with PHASE, press the  button until CLOCK is highlighted. Next, press the  or  button to adjust the clock.



6) Press the  button to confirm your selection and return to the MAIN CONTROLS window. CLOSE MAIN CONTROLS is highlighted.



Smart Help

After returning to MAIN CONTROLS...

Smart
Help

... to continue to ADJUST COLOR, press the  button until ADJUST COLOR is highlighted. Next, start with step 3 under ADJUST COLOR and follow the directions.

... to exit completely, press the  button.

[RETURN TO TOP OF THE PAGE](#)

ADJUST COLOR(*analog mode*)

Your monitor has three preset options you can choose from. The first option is ORIGINAL PANEL COLOR, which is fine and recommended for most applications. The second option is CAD/CAM, which is useful for computer-aided design programs. The third option is IMAGE MANAGEMENT, which includes projects such as desktop publishing, watching a DVD from your DVD player, and viewing pictures on the World Wide Web. When you select one of these options, the monitor automatically adjusts itself to that option. There is a fourth option, USER PRESET, which allows you to adjust the colors on your screen to a setting you desire.



1) Press the  button on the monitor. The MAIN CONTROLS window appears. LANGUAGE is highlighted.

2) Press the  button until ADJUST COLOR is highlighted.

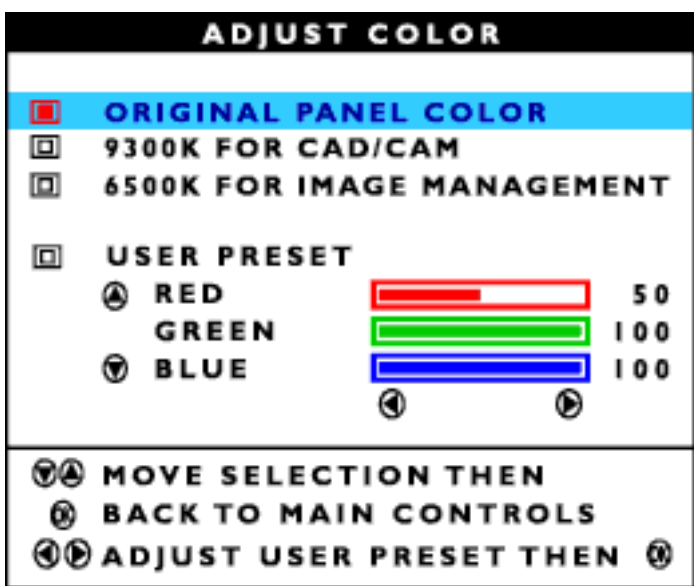

3) Press the  button. The ADJUST COLOR window appears.



4) Press the  or  button to select ORIGINAL PANEL COLOR, 9300K FOR CAD/CAM, 6500K FOR IMAGE MANAGEMENT, or USER PRESET.

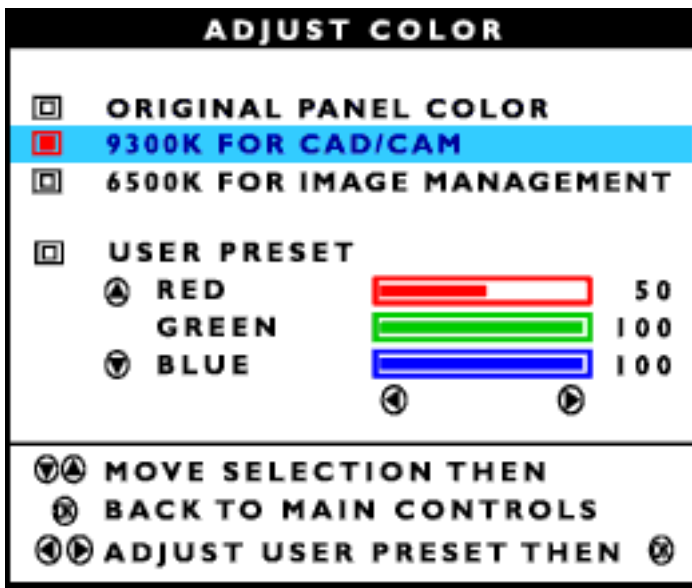



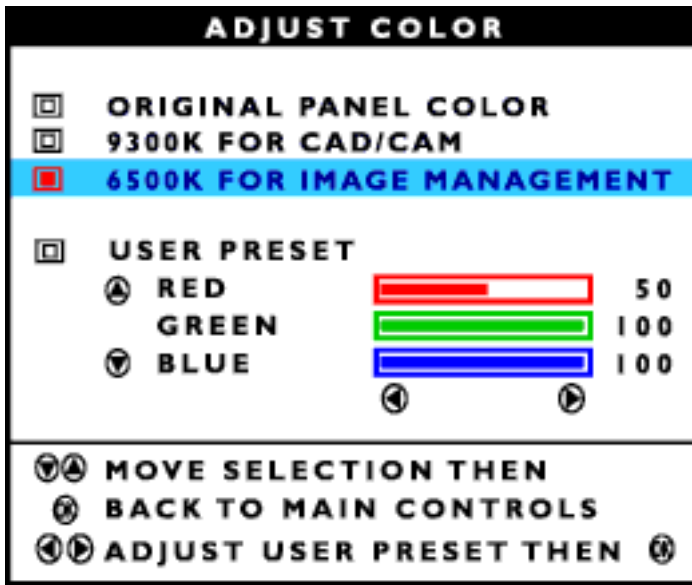

5) Once you have highlighted ORIGINAL PANEL COLOR, 9300K FOR CAD/CAM, or 6500K FOR IMAGE MANAGEMENT, press the  button to confirm your selection and return to the MAIN CONTROLS window. CLOSE MAIN CONTROLS is highlighted.

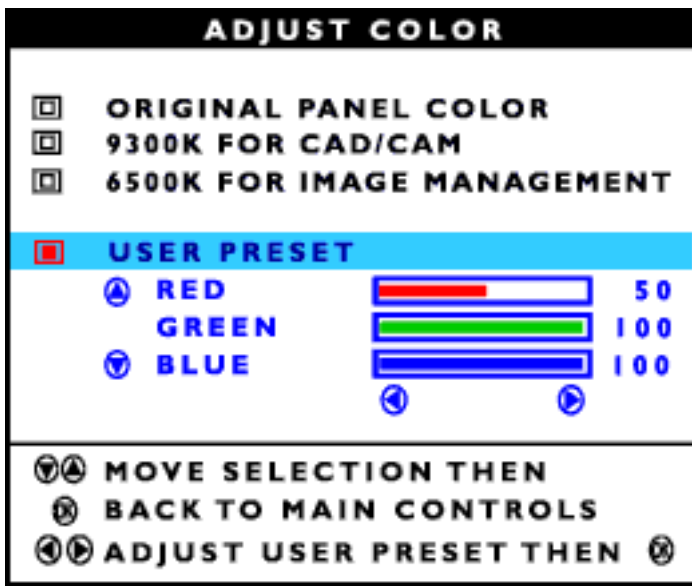

6a) If USER PRESET is highlighted, press the  button to highlight RED. Next, press the  or  button to adjust the color red.



6b) When finished with RED, press the  button to highlight GREEN. Next, press the  or  button to adjust the color green.

6c) When finished with GREEN, press the  button to highlight BLUE. Next, press the  or  button to adjust the color blue.

6d) When all adjustments are complete, press the  button to confirm your adjustments and return to the MAIN CONTROLS window. CLOSE MAIN CONTROLS is highlighted.



Smart Help

After returning to MAIN CONTROLS...

Smart
Help

... to continue to OSD SETTINGS, press the  button until OSD SETTINGS is highlighted. Next, start with step 3 under OSD SETTINGS and follow the directions.

... to exit completely, press the  button.

[RETURN TO TOP OF THE PAGE](#)

OSD SETTINGS

You can place the MAIN CONTROLS window almost any place on the screen that is convenient for you. OSD SETTINGS allows you to do this. It is composed of HORIZONTAL and VERTICAL adjustments you can make by simply following the step below.

1) Press the  button on the monitor. The MAIN CONTROLS window appears. LANGUAGE is highlighted.



2) Press the  button until OSD SETTINGS is highlighted.



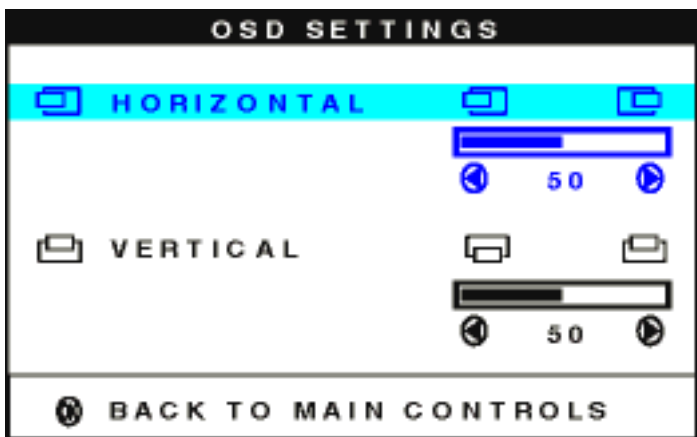

3) Press the  button. The OSD SETTINGS window appears. HORIZONTAL is highlighted.

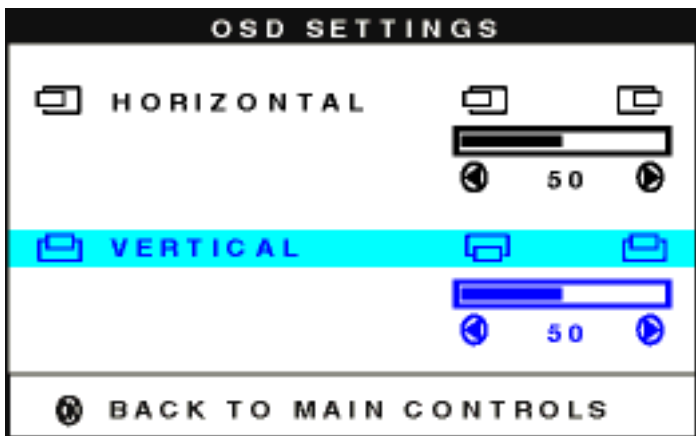

4) Press the  or  button to move the MAIN CONTROLS window left or right to the desired position.

5) Press the  button until VERTICAL is highlighted. Press the  or  button to move the MAIN CONTROLS window up or down to the desired position.



6) Press the  button to confirm your selections and return to the MAIN CONTROLS window. CLOSE MAIN CONTROLS is highlighted.



Smart Help

After returning to MAIN CONTROLS...

Smart
Help

... to continue to PRODUCT INFORMATION, press the  button until PRODUCT INFORMATION is highlighted. Next, start with step 3 under PRODUCT INFORMATION and follow the directions.

... to exit completely, press the  button.

[RETURN TO TOP OF THE PAGE](#)

PRODUCT INFORMATION

The PRODUCT INFORMATION window displays the monitor's serial number and the resolution of the monitor, all in one easy place. This is an information window only. Nothing can be adjusted in this window. To view this information, simply follow the steps below.

1) Press the  button on the monitor. The MAIN CONTROLS window appears. LANGUAGE is highlighted.

2) Press the  button until PRODUCT INFORMATION is highlighted.



3) Press the  button. The PRODUCT INFORMATION window appears. This window shows the monitor's SERIAL NUMBER and RESOLUTION of the monitor.

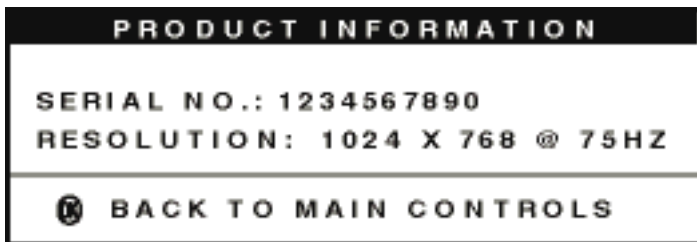

4) Press the  button to return to the MAIN CONTROLS window. CLOSE MAIN CONTROLS is highlighted.



Smart Help

After returning to MAIN CONTROLS...

Smart
Help

... to continue to RESET TO FACTORY SETTINGS, press the  button until RESET TO FACTORY SETTINGS is highlighted. Next, start with step 3 under RESET TO FACTORY SETTINGS and follow the directions.

... to exit completely, press the  button.

[RETURN TO TOP OF THE PAGE](#)

RESET TO FACTORY SETTINGS



RESET TO FACTORY SETTINGS returns everything in all the windows to factory presets. This means all adjustments that you may have made will be returned to the original settings.

- 1) Press the OK button on the monitor. The MAIN CONTROLS window appears. LANGUAGE is highlighted.
- 2) Press the  button until RESET TO FACTORY SETTINGS is highlighted.



- 3) Press the  button. The RESET TO FACTORY SETTINGS window appears.



- 4) Press the  or  button to select YES or NO. NO is the default. YES returns all settings to their original factory adjustments.
- 5) Press the  button to confirm your selections and return to the MAIN CONTROLS window. CLOSE MAIN CONTROLS is highlighted.



Smart Help

After returning to MAIN CONTROLS...

Smart
Help

... to continue to INPUT SELECTION, press the  button until INPUT SELECTION is highlighted. Next, start with step 3 under INPUT SELECTION and follow the directions. (Note: INPUT SELECTION is not available on all monitors. If not on your monitor, RESET TO FACTORY SETTINGS is your last selection.)

... to exit completely, press the  button.

[RETURN TO TOP OF THE PAGE](#)



INPUT SELECTION *(not available on all monitors)*

INPUT SELECTION allows you to decide whether the video input into your monitor comes from a digital or analog source. This is determined by how the video signal is sent from your computer to your monitor.

To find out if the signal is digital or analog, first consult the owner's manual for your computer. Second, make sure you have the correct connection made to your monitor. If your computer supports both analog and digital output, you can also use this setting to switch between the two video signals as desired.

- 1) Press the OK button on the monitor. The MAIN CONTROLS window appears. LANGUAGE is highlighted.
- 2) Press the  button until INPUT SELECTION is highlighted.



- 3) Press the  button. The INPUT SELECTION window appears.
- 4) Press the  or  button to select either ANALOG or DIGITAL.

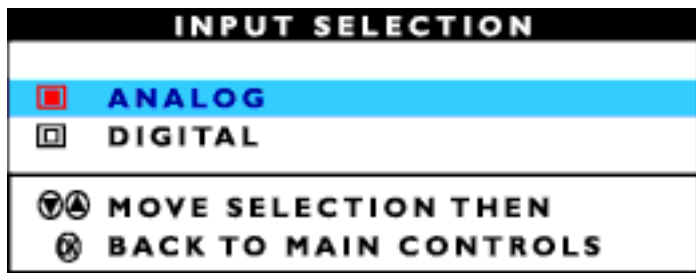

5) Press the  button to confirm your selections and return to the MAIN CONTROLS window. CLOSE MAIN CONTROLS is highlighted.



Smart Help

After returning to MAIN CONTROLS...

Smart
Help

... to exit completely, press the  button.

[RETURN TO TOP OF THE PAGE](#)

Close Main Controls



[RETURN TO TOP OF THE PAGE](#)

Your International Philips F1rst Choice Warranty

Thank you for purchasing this Philips monitor.



All Philips monitors are designed and manufactured to high standards and deliver high-quality performance, ease of use and ease of installation. Should you encounter any difficulties while installing or using this product, please contact Philips directly to benefit from your Philips F1rst Choice Warranty. This three-year service warranty entitles you to a swap model on-site within 48 hours of your call being received.

An extended warranty called Philips F1rst Choice Premium is available in addition to your Philips F1rst Choice warranty. For more details contact your Philips dealer.

Before contacting Philips, please prepare the following details so we can solve your problem quickly.

- Philips type number
- Philips serial number
- Purchase date (copy of purchase may be required)
- PC environment Processor:
 - 286/386/486/Pentium Pro/Internal memory
 - Operating system (Windows, DOS, OS/2, MAC)
 - Fax/Modem/Internet program?
- Other cards installed

Having the following information available will also help speed up the process:

- Your proof of purchase indicating: date of purchase, dealer name, model and product serial number.
- The full address to which the swap model should be delivered.

Just a phone call away

Philips' customer help desks are located worldwide. You can contact Philips Monday - Friday from 08.00 - 20.00 hrs Central European Time (CET) and on Saturdays and Sundays from 10.00 to 18.00 hrs CET by using one of the toll-free numbers. Click here to access the [F1rst Choice Contact Information](#). Or you can reach us via:

Website: <http://www.philips.com>

Your International Guarantee

Dear Customer,

Thank you for purchasing this Philips product which has been designed and manufactured to the highest quality standards.

If, unfortunately, something should go wrong with this product Philips guarantees free of charge labor and replacement parts irrespective of the country where it is repaired during a period of 12 months from date of purchase. This international Philips guarantee complements the existing national guarantee obligations to you of dealers and Philips in the country of purchase and does not affect your statutory rights as a customer.

The Philips guarantee applies provided the product is handled properly for its intended use, in accordance with its operating instructions and upon presentation of the original invoice or cash receipt, indicating the date of purchase, dealer's name and model and production number of the product.

The Philips guarantee may not apply if:

- the documents have been altered in any way or made illegible;
- the model or production number on the product has been altered, deleted, removed or made illegible;
- repairs or product modifications and alterations have been executed by unauthorized service organizations or persons;
- damage is caused by accidents including but not limited to lightning, water or fire, misuse or neglect.

Please note that the product is not defective under this guarantee in the case where modifications become necessary in order for the product to comply with local or national technical standards which apply in countries for which the product was not originally designed and/or manufactured. Therefore always check whether a product can be used in a specific country.

In case your Philips product is not working correctly or is defective, please contact your Philips dealer. In the event you require service whilst in another country a dealer address can be given to you by the Philips Consumer Help Desk in that country, the telephone and fax number of which can be found in the relevant part of this booklet.

In order to avoid unnecessary inconvenience, we advise you to read the operating instructions carefully before contacting your dealer. If you have questions which your dealer cannot answer or any related question please contact the [Philips Consumer Information Centers](#) or via:

Website: <http://www.philips.com>

LIMITED WARRANTY (Computer Monitor)

Three Years Free Labor / Three Years Free Service on Parts / One Year Exchange*

**Product will be exchanged with a new or renewed to original specifications unit within two business days for the first year. This product must be shipped in at your expense for service during years two and three.*

WHO IS COVERED?

You must have proof of purchase to receive warranty service. A sales receipt or other document showing that you purchased the product is considered proof of purchase. Attach it to this owner's manual and keep both nearby.

WHAT IS COVERED?

Warranty coverage begins the day you buy your product. *For three years thereafter*, all parts will be repaired or replaced, and labor is free. *After three years from the day of purchase*, you pay for the replacement or repair of all parts, and for all labor charges.

All parts, including repaired and replaced parts, are covered only for the original warranty period. When the warranty on the original product expires, the warranty on all replaced and repaired products and parts also expires.

WHAT IS EXCLUDED?

Your warranty does not cover:

- labor charges for installation or setup of the product, adjustment of customer controls on the product, and installation or repair of antenna systems outside of the product.
- product repair and/or part replacement because of misuse, accident, unauthorized repair or other cause not within the control of Philips Consumer Electronics.
- reception problems caused by signal conditions or cable or antenna systems outside the unit.
- a product that requires modification or adaptation to enable it to operate in any country other than the country for which it was designed, manufactured, approved and/or authorized, or repair of products damaged by these modifications.
- incidental or consequential damages resulting from the product. (Some states do not allow the exclusion of incidental or consequential damages, so the above exclusion may not apply to you. This includes, but is not limited to, prerecorded material, whether copyrighted or not copyrighted.)
- a product used for commercial or institutional purposes.

Where IS SERVICE AVAILABLE?

Warranty service is available in all countries where the product is officially distributed by Philips Consumer Electronics. In countries where Philips Consumer Electronics does not distribute the product, the local

Philips service organization will attempt to provide service (although there may be a delay if the appropriate spare parts and technical manual(s) are not readily available).

Where CAN I GET MORE INFORMATION?

For more information, contact the Philips Customer Care Center by calling [\(800\) 835-3506 \(U.S.A. customers only\)](tel:8008353506) or [\(423\) 475-0280](tel:4234750280).

Before Requesting Service...

Please check your owner's manual before requesting service. Adjustments of the controls discussed there may save you a service call.

TO GET WARRANTY SERVICE IN U.S.A., PUERTO RICO OR U.S. VIRGIN ISLANDS...

Contact the Philips Customer Care Center phone number listed below for product assistance and procedures for servicing:

Philips Customer Care Center

(800) 835-3506 or (423) 475-0280

(In U.S.A., Puerto Rico and U.S. Virgin Islands, all implied warranties, including implied warranties of merchantability and fitness for a particular purpose, are limited in duration to the duration of this express warranty. But, because some states do not allow limitations on how long an implied warranty may last, this limitation may not apply to you.)

TO GET WARRANTY SERVICE IN CANADA...

Please contact Philips at:

(800) 479-6696

Three years free parts and three years free labor will be provided at Philips Canada depot or any one of its authorized service centers.

(In Canada, this warranty is given in lieu of all other warranties. No other warranties are expressed or implied, including any implied warranties of merchantability or fitness for a particular purpose. Philips is not liable under any circumstances for any direct, indirect, special, incidental or consequential damages, howsoever incurred, even if notified of the possibility of such damages.)

REMEMBER... Please record the model and serial numbers found on the product below.

MODEL # _____

SERIAL # _____

This warranty gives you specific legal rights. You may have other rights which vary from state/province to state/province.

Philips Customer Care Center, P. O. Box 2976, Longview, TX 75601

Your International Philips F1rst Choice Warranty

Thank you for purchasing this Philips monitor.



All Philips monitors are designed and manufactured to high standards and deliver high-quality performance, ease of use and ease of installation. Should you encounter any difficulties while installing or using this product, please contact Philips directly to benefit from your Philips F1rst Choice Warranty. This three-year service warranty entitles you to a swap model on-site within 48 hours of your call being received within the first year of purchase. If you have any problems with your monitor within the second or third year of purchase, we will repair it after it has been sent to the service provider at your expense and returned to you within five working days, free of charge.

An extended warranty called Philips F1rst Choice Premium is available in addition to your Philips F1rst Choice warranty. For more details contact your Philips dealer.

Before contacting Philips, please prepare the following details so we can solve your problem quickly.

- Philips type number
- Philips serial number
- Purchase date (copy of purchase may be required)
- PC environment Processor:
 - 286/386/486/Pentium Pro/Internal memory
 - Operating system (Windows, DOS, OS/2, MAC)
 - Fax/Modem/Internet program?
- Other cards installed

Having the following information available will also help speed up the process:

- Your proof of purchase indicating: date of purchase, dealer name, model and product serial number.
- The full address to which the swap model should be delivered.

Just a phone call away

Philips' customer help desks are located worldwide. You can contact Philips Monday - Friday from 08.00 - 20.00 hrs Central European Time (CET) and on Saturdays and Sundays from 10.00 to 18.00 hrs CET by using one of the toll-free numbers. Click here to access the [F1rst Choice Contact Information](#). Or you can reach us via:

Website: <http://www.philips.com>