

**PHILIPS**



Search



Talk



Philips home

*Let's make things better*

▶ safety and troubleshooting

▶ about this manual

▶ product information

▶ installing your monitor

▶ on-screen display

▶ customer care and warranty

▶ glossary

▶ download & print

**electronic**

# 150B<sub>2</sub>B

## USER'S MANUAL



# Safety and Troubleshooting Information

[Safety Precautions and Maintenance](#) • [Installation Locations](#) • [FAQs](#) • [Troubleshooting](#) • [Regulatory Information](#) • [Other Related Information](#)

---

## Safety precautions and maintenance



**WARNING: Use of controls, adjustments, or procedures other than those specified in this documentation may result in exposure to shock, electrical hazards, and/or mechanical hazards.**

Read and follow these instructions when connecting and using your computer monitor:

- Unplug the monitor, if you are not going to use it for an extensive period of time.
- Unplug the monitor, if you need to clean it with a slightly damp cloth. Wiping the screen with a dry cloth is possible when the power is off. However, never use alcohol, solvents, or ammonia-based liquids.
- Consult a service technician if the monitor does not operate normally when following the instructions in this manual.
- The casing cover should be opened only by qualified service personnel.
- Keep the monitor out of direct sunlight and away from stoves or any other heat source.
- Remove any object that could fall into the vents or prevent proper cooling of the monitor's electronics.
- Do not block the ventilation holes on the cabinet.
- Keep the monitor dry. To avoid electric shock, do not expose it to rain or excessive moisture.
- When positioning the monitor, make sure the power plug and outlet are easily accessible.
- If turning off the monitor by detaching power cable or DC power cord, wait for 6 seconds, then attach the power cable or DC power cord for normal operation.
- To avoid the risk of shock or permanent damage to the set, do not expose the monitor to rain or excessive moisture.
- When positioning the monitor, make sure the power plug and outlet are easily accessible.
- **IMPORTANT:** Always activate a screen saver program during your application . If a still image in high contrast remains on the screen for an extended period of time, it may leave a so called "after-image" or "ghost image" in front of the screen. This is a well-known phenomenon that is caused by the shortcomings inherent in the LCD technology. Most of the time the after-image will disappear gradually over a period of time after switching off the power. Be aware that the after-image symptom can not be repaired and is not covered under warranty.

Consult a service technician if the monitor does not operate normally when operating instructions of this manual are followed.

[RETURN TO TOP OF THE PAGE](#)

---

## Installation Locations

- Avoid Heat and Extreme Cold
- Do not store or use the LCD monitor in locations exposed to heat, direct sunlight, or extreme cold.
- Avoid moving the LCD monitor between locations with large temperature differences. Choose a site falling within the following temperature and humidity ranges.
  - Temperature: 5-35°C 41-95°F
  - Humidity: 20-80% RH
- Do not subject the LCD monitor to severe vibration or high impact conditions. Do not place the LCD monitor inside a car trunk.
- Take care not to mishandle this product by either knocking or dropping during operation or transportation.
- Do not store or use the LCD monitor in locations exposed to high humidity or a dusty environment. Also do not allow water or other liquids to spill on or into the LCD monitor.

[RETURN TO TOP OF THE PAGE](#)

# About This Manual

[About This Guide](#) • [Notational Descriptions](#)

---

## About This Guide

This electronic user's guide is intended for anyone who uses the Philips LCD Monitor. It describes the LCD monitor's features, setup, operation and other pertinent information. Its contents are identical to the information in our printed version.

Sections are as follows:

- [Safety and Troubleshooting Information](#) provides tips and solutions for common problems as well as other related information you may need.
- About This Electronic User's Manual gives an overview of information included, along with notation icon descriptions and other documentation for your reference.
- [Product Information](#) gives an overview of the monitor's features and as well as the technical specifications for this monitor.
- [Installing Your Monitor](#) describes the initial setup process and gives an overview of how to use the monitor.
- [On Screen Display](#) provides information on adjusting the settings on your monitor.
- [Customer Care and Warranty](#) contains a list of worldwide Philips Consumer Information Centers along with help desk phone numbers and information on the warranty applicable to your product.
- [Glossary](#) defines technical terms.
- [Download and Print Option](#) transfers this entire manual to your hard drive for easy reference.

[RETURN TO TOP OF THE PAGE](#)

---

## Notational Descriptions

The following subsections describe notational conventions used in this document.

### Notes, Cautions, and Warnings

Throughout this guide, blocks of text may be accompanied by an icon and printed in bold or italic type. These blocks contain notes, cautions, or warnings. They are used as follows:



**NOTE: This icon indicates important information and tips that help you make better use of your computer system.**



**CAUTION:** This icon indicates information that tells you how to avoid either potential damage to hardware or loss of data.



**WARNING:** This icon indicates the potential for bodily harm and tells you how to avoid the problem.

Some warnings may appear in alternate formats and may be unaccompanied by an icon. In such cases, the specific presentation of the warning is mandated by regulatory authority.

[RETURN TO TOP OF THE PAGE](#)

---

©2001 Koninklijke Philips Electronics N.V.

All rights reserved. Reproduction, copying, usage, modifying, hiring, renting, public performance, transmission and/or broadcasting in whole or in part is prohibited without written consent of Philips Electronics N.V.

# Product Information

[Product Features](#) • [Technical Specifications](#) • [Resolution & Preset Modes](#) • [Philips Pixel Defect Policy](#) • [Automatic Power Saving](#) • [Physical Specification](#) • [Pin Assignment](#) • [Product Views](#) • [Physical Function](#)

## Product Features

### 150B2B

- 15" color LCD monitor with excellent display performance
- VGA analog input
- Embedded universal AC power supply
- Advance AUTO adjustment optimizes picture quality
- User installable bezel for optional protective cover choice and touch panel design solution
- Optional USB powered hub with 4 downstream port
- Optional protective cover to prevent LCD screen damage

[RETURN TO TOP OF THE PAGE](#)

## Technical Specifications\*

### LCD PANEL

• Type	TFT LCD
• Screen size	15" visual
• Pixel Pitch	0.297 x 0.297mm (15.0")
• LCD Panel type	1024 x 768 pixels R.G.B. vertical stripe Anti-glare polarizer hardness
• Effective viewing area	304.1 x 228.1mm (15.0")
• Display Colors	8 bits interface (16M colors)

### SCANNING

• Vertical refresh rate	56Hz-76Hz
• Horizontal frequency	30KHz-61KHz

**VIDEO**

• Video dot rate	80 MHz
• Input impedance	
- Video	75 ohm
- Sync	2K Ohm
• Input signal levels	700m Vpp
• Sync input signal	Separate sync Composite sync** / Sync on Green**
• Sync polarities	Positive and negative
• Input Frequency	XGA Hsync                      48- 61 KHz, Vsync 60 - 76 Hz (N.I.) SVGA Hsync                    35- 50 KHz, Vsync 56 - 75 Hz (N.I.) VGA Hsync                      31- 38 KHz, Vsync 60 - 76 Hz (N.I.)
• Video interface	Analog (D-Sub)

**OPTICAL CHARACTERISTICS**

• Contrast ratio	300 (typ.)
• Brightness	200 cd/m <sup>2</sup> (typ.)
• Peak contrast angle	6 o'clock
• White Chromacity	x: 0.281 y: 0.311 (at 9300° K) x: 0.312 y: 0.338 (at 6500° K)
• Viewing Angle (C/R >5)	Upper ≥50 ° (typ.) Lower ≥60° (typ.) Left ≥75 ° (typ.) Right ≥75 ° (typ.)
• Response time	<=45ms (typ.)

\* These information are subject to change without notice.

\*\* The following signal modes (Composite sync / Sync on Green) may not perfectly display due to the components limitation.

Resolution	Resolution
640 x 350 / 70Hz	800 x 600 / 72Hz
640 x 480 / 66Hz	1024 x 768 / 60Hz
640 x 480 / 75Hz	1024 x 768 / 70Hz
800 x 600 / 56Hz	

[RETURN TO TOP OF THE PAGE](#)

## Resolution & Preset Modes

- Maximum 1024 x 768 at 75Hz
- Recommended 1024 x 768 at 60Hz

### 14 user definable modes

#### 14 factory preset modes:

H. freq (KHz)	Resolution	V. freq (Hz)
31.469	640*350	70.086
31.469	720*400	70.087
31.469	640*480	59.940
35.000	640*480	67.000
37.861	640*480	72.809
37.500	640*480	75.000
35.156	800*600	56.250
37.879	800*600	60.317
48.077	800*600	72.188
46.875	800*600	75.000
49.700	832*624	75.000
48.363	1024*768	60.004
56.476	1024*768	70.069
60.023	1024*768	75.029

[RETURN TO TOP OF THE PAGE](#)

## Automatic Power Saving

If you have VESA's DPMS compliance display card or software installed in your PC, the monitor can automatically reduce its power consumption when not in use. And if an input from a keyboard, mouse or other input device is detected, the monitor will automatically "wake up". The following table shows the power consumption and signaling of this automatic power saving features:



## Power Management Definition

VESA Mode	Video	H-sync	V-sync	Power Used	LED color
ON	Active	Yes	Yes	< 23W	Green
Stand-by	Blanked	No	Yes	< 3W	Amber
Suspend	Blanked	Yes	No	< 3W	Amber
OFF	Blanked	No	No	< 3W	Amber

This monitor is ENERGY STAR® compliant. As an ENERGY STAR® Partner, PHILIPS has determined that this product meets the ENERGY STAR® guidelines for energy efficiency.

[RETURN TO TOP OF THE PAGE](#)

## Physical Specifications

• Dimension (WxHxD)	380 x 360 x 165 mm (incl. Pedestal)
• Weight	5 Kg
• Swivel	+/- 175°
• Tilt (Forward / Backward)	- 5° / 25°
• Power supply	100 — 240 VAC, 50/60 Hz
• Power consumption	23 W (typ.)
• Temperature (operating)	5° C to 35° C
• Relative humidity	20% to 80%
• System MTBF	50K hrs (CCFL 40 Khrs)

\* These information are subject to change without notice.

[RETURN TO TOP OF THE PAGE](#)

## Pin Assignment

The 15-pin D-sub connector (male) of the signal cable:

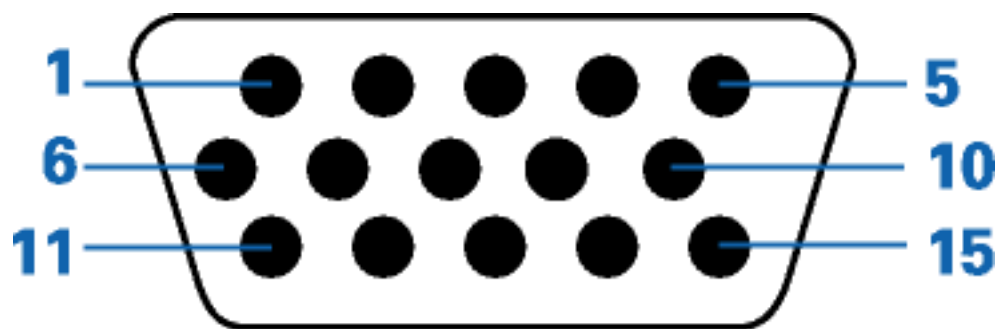

Pin No.	Assignment	Pin No.	Assignment
1	Red video input	9	DDC +5V
2	Green video input	10	Logic ground
3	Blue video input	11	Identical output - connected to pin 10
4	Identical output - connected to pin 10	12	Serial data line (SDA)
5	Cabel detect	13	H. Sync / H+V
6	Red video ground	14	V. Sync
7	Green video ground	15	Data clock line (SCL)
8	Blue video ground		

[RETURN TO TOP OF THE PAGE](#)

## Product Views

Follow the links to see various views of the monitor and its components.

[Front View Product Description](#)

[RETURN TO TOP OF THE PAGE](#)

## Physical Function

**1) Tilt**

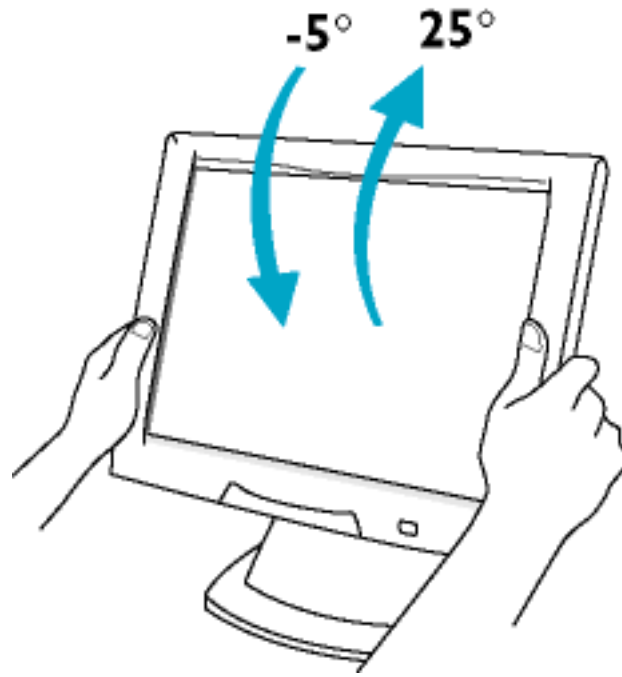

**2) Swivel**



[RETURN TO TOP OF THE PAGE](#)

# Installing your LCD Monitor

Your LCD Monitor : [Front View Product Description](#) • [Connecting to Your PC](#) • [Getting Started](#) • [Optimizing Performance](#) • [Accessories \(optional\)](#)

---

## Front View Product Description

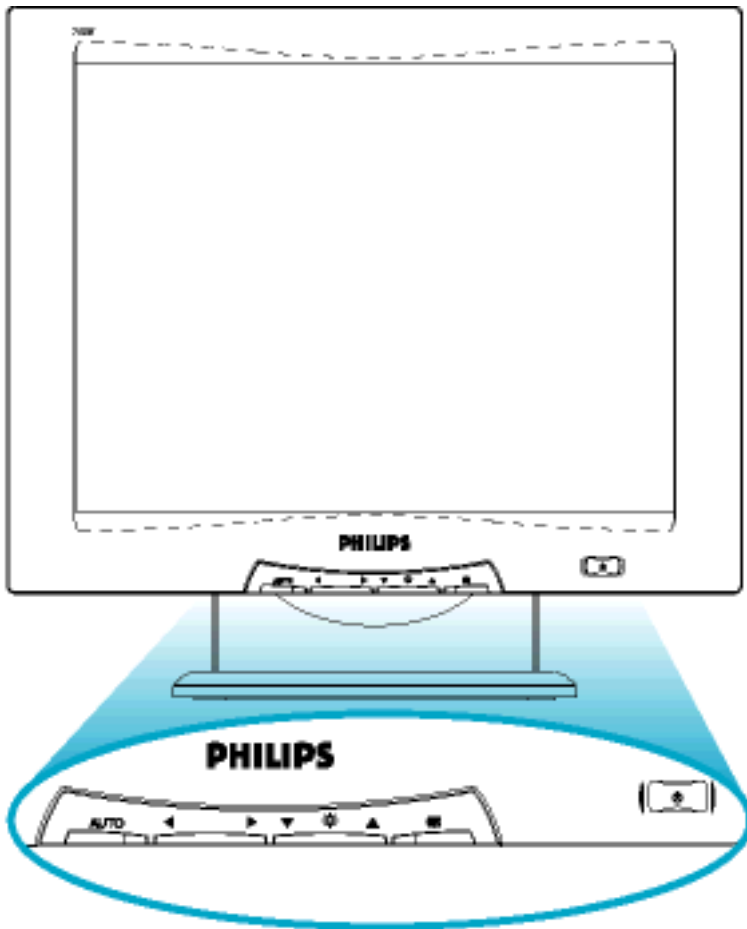

UP and DOWN buttons are used when adjusting the OSD of your monitor



LEFT and RIGHT buttons, like the UP and DOWN buttons, are also used in adjusting the OSD of your monitor.



BRIGHTNESS hotkey. When the UP and DOWN arrow buttons are pressed, the adjustment controls for the BRIGHTNESS will show up.



OK button which when pressed will take you to the OSD controls



POWER button switches your monitor on

**AUTO**

Automatically adjust the horizontal position, vertical position, phase and clock setting.

[RETURN TO TOP OF THE PAGE](#)

---

## Optimizing Performance

- For best performance, ensure that your display settings are set at 1024x768@60Hz (for14"/15") or 1280x1024, 60Hz (for17"/18").



**Note:** You can check the current display settings by pressing the "OK" button once. Go into the Product Information. The current display mode is shown on the item called RESOLUTION.

- You can also install the [Flat Panel Adjust \(FP Adjust\) program](#), a program for getting the best performance out of your monitor, included in this CD. A step-by-step instructions is provided to guide you through the installtion process. Click on the link to know more about this program.

More about



[FP\\_setup01.exe](#)

[RETURN TO TOP OF THE PAGE](#)

# On-Screen Display

[Description of the On-Screen Display](#) • [The OSD Tree](#)





---

## Description of the On Screen Display

### *What is the On-Screen Display?*

This is a feature in all Philips LCD monitors which allows an end-user to adjust screen performance of monitors directly through an on-screen instruction window. The user interface provides user-friendliness and ease-of-use when operating the monitor.

### *Basic and simple instruction on the control keys.*

On the front controls of your monitor, once you press the  button, the On Screen Display (OSD) Main Controls window will pop up and you can now start making adjustments to your monitor's various features. Use the   or the   keys to make your adjustments within.



[RETURN TO TOP OF THE PAGE](#)

---

## The OSD Tree

Below is an overall view of the structure of the On-Screen Display. You can use this as reference when you want to later on work your way around the different adjustments.

**Analog signal input:**

First Level

Second Level

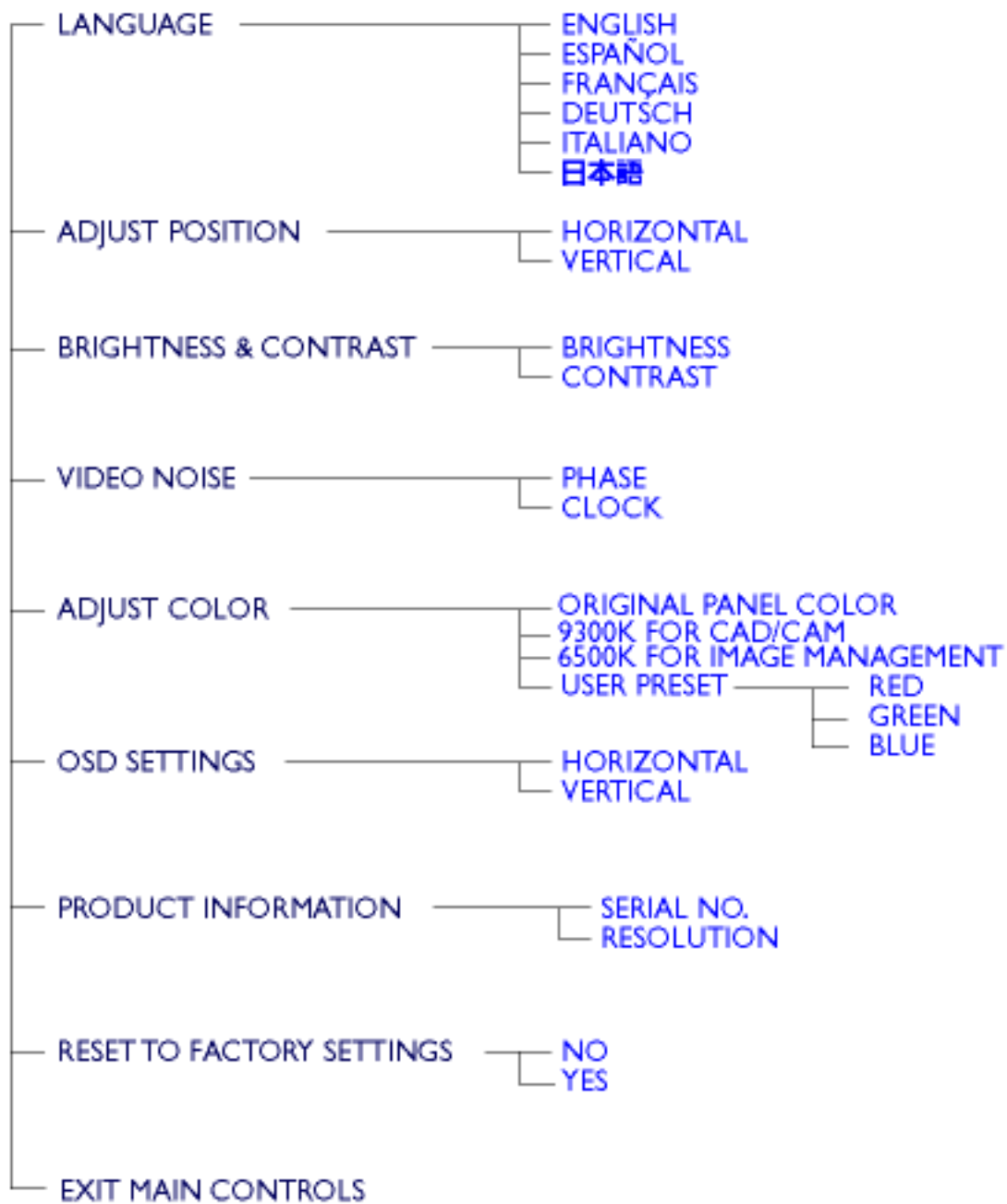

• Specifications are subject to change without prior notice.

[RETURN TO TOP OF THE PAGE](#)



# Customer Care & Warranty

PLEASE SELECT YOUR COUNTRY/AREA TO REVIEW DETAILS OF YOUR WARRANTY COVERAGE

**WESTERN EUROPE:** [Austria](#) • [Belgium](#) • [Cyprus](#) • [Denmark](#) • [France](#) • [Germany](#) • [Greece](#) • [Finland](#) • [Ireland](#) • [Italy](#) • [Luxembourg](#) • [the Netherlands](#) • [Norway](#) • [Portugal](#) • [Sweden](#) • [Switzerland](#) • [Spain](#) • [United Kingdom](#)

**EASTERN EUROPE:** [Czech Republic](#) • [Hungary](#) • [Poland](#) • [Russia](#) • [Turkey](#)

**LATIN AMERICA:** [Antilles](#) • [Argentina](#) • [Brasil](#) • [Chile](#) • [Colombia](#) • [Mexico](#) • [Paraguay](#) • [Peru](#) • [Uruguay](#) • [Venezuela](#)

**NORTH AMERICA:** [Canada](#) • [USA](#)

**PACIFIC:** [Australia](#) • [New Zealand](#)

**ASIA:** [Bangladesh](#) • [China](#) • [Hong Kong](#) • [India](#) • [Indonesia](#) • [Japan](#) • [Korea](#) • [Malaysia](#) • [Pakistan](#) • [Philippines](#) • [Singapore](#) • [Taiwan](#) • [Thailand](#)

**AFRICA:** [Morocco](#) • [South Africa](#)

**MIDDLE EAST:** [Dubai](#) • [Egypt](#)

---

# Glossary

A B C D E F G H I J K L M N O P Q R S T U V W X Y Z

---

## C

### *Color temperature*

A way of describing the color of a radiating source in terms of the temperature (in degrees Kelvin) of a black body radiating with the same dominant frequency as the source.

Most Philips monitors offer the possibility of setting the color temperature to any desired value.

[RETURN TO TOP OF THE PAGE](#)

---

## D

### *D-SUB USB*

Your monitor comes with a D-Sub cable.

### *Digital Visual Interface (DVI)*

The Digital Visual Interface (DVI) specification provides a high-speed digital connection for visual data types that is display technology independent. The interface is primarily focused at providing a connection between a computer and its display device. The DVI specification meets the needs of all segments of the PC industry (workstation, desktop, laptop, etc.) and will enable these different segments to unite around one monitor interface specification.

The DVI interface enables:

1. Content to remain in the lossless digital domain from creation to consumption.
2. Display technology independence.
3. Plug and play through hot plug detection, EDID and DDC2B.
4. Digital and Analog support in a single connector.

[RETURN TO TOP OF THE PAGE](#)

**E***Energy Star Computers Programme*

An energy conservation programme launched by the US Environmental Protection Agency (EPA) with the primary aim of promoting the manufacture and marketing of energy-efficient office automation equipment. Companies joining this programme must be willing to commit themselves to manufacturing one or more products capable of going into a low -power state (< 30 W) either after a period of inactivity or after a predetermined time selected by the user.

[RETURN TO TOP OF THE PAGE](#)

---

**L***LCD Liquid Crystal Display*

An alphanumeric display using the unique properties of liquid crystal to form characters. The latest flat-panel displays comprise a matrix of hundreds or thousands of individual LCD cells that generate text and colorful graphics on a screen. They consume little power though they do require external lighting to make them legible to the user.

[RETURN TO TOP OF THE PAGE](#)

---

**U***USB or Universal Serial Bus*

[A smart plug for PC peripherals.](#) USB automatically determines resources (like driver software and bus bandwidth) required by peripherals. USB makes necessary resources available without user intervention.

- USB eliminates "case angst" -- the fear of removing the computer case to install add-on peripherals. And USB also eliminates adjustment of complicated IRQ settings when installing new peripherals.
- USB does away with "port gridlock." Without USB, PCs are normally limited to one printer, two Com port devices (usually a mouse and modem), one Enhanced Parallel Port add-on (scanner or video camera, for example) and a joystick. More and more peripherals for multimedia computers arrive on the market every day. With USB, up to 127 devices can run simultaneously on a computer.
- USB permits "hot plug-in." There's no need to shut down, plug in, reboot and run set-up to install peripherals. And no need to go through the reverse process to unplug a device.

In short, USB transforms today's "Plug-and-Pray" into true Plug-and-Play!

**Hub**

A Universal Serial Bus device that provides additional connections to the Universal Serial Bus.

Hubs are a key element in the plug-and-play architecture of USB. The Figure shows a typical hub. Hubs serve to simplify USB connectivity from the user's perspective and provide robustness at low cost and complexity.

Hubs are wiring concentrators and enable the multiple attachment characteristics of USB. Attachment points are referred to as ports. Each hub converts a single attachment point into multiple attachment points. The architecture supports concatenation of multiple hubs.

The upstream port of a hub connects the hub towards the host. Each of the other downstream ports of a hub allows connection to another hub or function. Hubs can detect, attach and detach at each downstream port and enable the distribution of power to downstream devices. Each downstream port can be individually enabled and configured at either full or low speed. The hub isolates low speed ports from full speed signaling.

A hub consists of two portions: the Hub Controller and Hub Repeater. The repeater is a protocol-controlled switch between the upstream port and downstream ports. It also has hardware support for reset and suspend/resume signaling. The controller provides the interface registers to allow communication to/from the host. Hub specific status and control commands permit the host to configure a hub and to monitor and control its ports.

### Device

A logical or physical entity that performs a function. The actual entity described depends on the context of the reference. At the lowest level, device may refer to a single hardware component, as in a memory device. At a higher level, it may refer to a collection of hardware components that perform a particular function, such as a Universal Serial Bus interface device. At an even higher level, device may refer to the function performed by an entity attached to the Universal Serial Bus; for example, a data/FAX modem device. Devices may be physical, electrical, addressable, and logical.

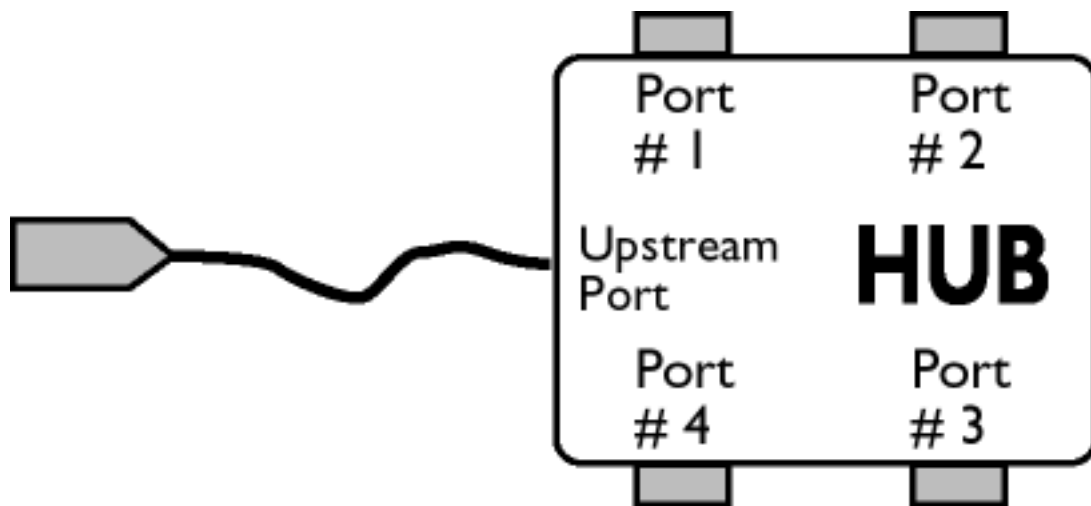

### Downstream

The direction of data flow from the host or away from the host. A downstream port is the port on a hub electrically farthest from the host that generates downstream data traffic from the hub. Downstream ports receive upstream data traffic.

## Upstream

The direction of data flow towards the host. An upstream port is the port on a device electrically closest to the host that generates upstream data traffic from the hub. Upstream ports receive downstream data traffic.

[RETURN TO TOP OF THE PAGE](#)

---

## V

### *Vertical refresh rate*

Expressed in Hz, it is the number of frames (complete pictures) written to the screen every second.

[RETURN TO TOP OF THE PAGE](#)

# Download and Print

[Installing your LCD monitor driver](#) • [Download and Printing Instructions](#) • [Installing FPadjust Program](#)

---

## Installing Your LCD monitor driver

*System requirements:*

- PC running Windows 95, Windows 98, Windows 2000 , Windows Me, Windows XP or later
- Find your driver ".inf/.icm/.cat" at : /PC/drivers/

**Read the "Driver\_install02.txt" file before installing.**

---

This page provides an option to read the manual in .pdf format. PDF files can be downloaded into your hard disk, then viewed and printed with Acrobat Reader or through your browser.

If you do not have Adobe® Acrobat Reader installed, click on the link to install the application. [Adobe® Acrobat Reader for PC](#) / [Adobe® Acrobat Reader for Mac](#).

### **Download instructions:**

To download the file:

1. Click-and-hold your mouse over the icon below. (Win95/98/2000/Me/XP users right-click)

Download



[150P2E.pdf](#)

Download



[150P2D.pdf](#)

Download



[150P2M.pdf](#)

Download



[150P2G.pdf](#)

Download



[150B2B.pdf](#)

Download



[150S2B.pdf](#)

2. From the menu that appears, choose 'Save Link As...', 'Save Target As...' or 'Download Link to Disk'.
3. Choose where you would like to save the file; click 'Save' (if prompted to save as either 'text' or 'source', choose 'source').

### ***Printing instructions:***

To print the manual:

1. With the manual file open, follow your printer's instructions and print the pages you need.

[RETURN TO TOP OF THE PAGE](#)

---

## **Installing FPadjust Program**

The FP Adjust program generates alignment patterns which will help you adjust monitor settings such as CONTRAST, BRIGHTNESS, HORIZONTAL & VERTICAL POSITION, PHASE and CLOCK.

*System requirements:*

- PC running Windows 95, Windows 98, Windows 2000, Windows Me, Windows XP or later

*To install FPadjust Program:*

- Click on the link or icon to install FPadjustment Program.  
or
- Click-and-hold your mouse over the icon. (Win95/98/2000/Me/XP users right-click)

Download



[FP\\_setup01.exe](#)

- From the menu that appears, choose 'Save Link As...', 'Save Target As...' or 'Download Link to Disk'.
- Choose where you would like to save the file; click 'Save' (if prompted to save as either 'text' or 'source', choose 'source').
- Exit your browser and install the FPadjust Program.

**Read the "FP\_Readme01.txt" file before installing.**

[RETURN TO TOP OF THE PAGE](#)





# FAQs (Frequently Asked Questions)

[Safety and Troubleshooting](#) • [General FAQ](#) • [Screen Adjustments](#) • [Compatibility with Other Peripherals](#) • [LCD Panel Technology](#) • [Ergonomics, Ecology, and Safety Standards](#) • [Troubleshooting](#) • [Regulatory Information](#) • [Other Related Information](#)

---

## General FAQs

**Q:** When I install my monitor how do I do if the screen shows "Cannot display this video mode"?

**A:** Recommended video mode for Philips 14"/15": 1024x768 @60Hz for Philips 17"/18" 1280x1024@60Hz.

1. Unplug all cables, then connect your PC to the monitor that you used previously and which displayed correctly.
  2. In the Windows Start Menu, select Settings/Control Panel. In the Control Panel Window, select the Display icon. Inside the Display Control Panel, select the " Settings " tab. Under the setting tab, in box labeled " desktop area ", move the slider to 1024x768 pixels (14"/15") / 1280x1024 pixels (17"/18").
  3. Open " Advanced Properties " and set the Refresh Rate to 60Hz, then click OK.
  4. Restart your computer and repeat step 2 and 3 to verify that your PC is set at 1024x768@60Hz (14"/15") / 1280x1024@60Hz (17"/18").
  5. Shut down your computer, disconnect your old monitor and reconnect your Philips LCD monitor.
  6. Turn on your monitor and then turn on your PC
- 

**Q:** What should I do when screen shows: THIS IS 85HZ OVERSCAN, CHANGE COMPUTER DISPLAY INPUT TO 1024 x 768 @60HZ or THIS IS 85HZ OVERDRIVE, CHANGE COMPUTER DISPLAY INPUT TO 1280 x 1024 @60HZ?

**A:** It means the signal input from your PC is 85Hz -- outside the range that the monitor can display. New Generation LCD intelligent monitor capabilities temporarily override the overscan, providing you with 10 minutes to reset timing to recommended settings.

Here's how:

Go to your Windows Start menu. Select *Settings*, then *Control Panel*. Select *Display*. Move to *Settings* and click on the *Advanced* button. Under *Adaptor*, change the refresh rate to 56~75.

You have 10 minutes to complete the operation; if you do not complete within 10 minutes, power off and re-power on monitor to enter changes.

---

**Q:** What does "refresh rate" mean to me in an LCD monitor?

**A:** For LCD monitors, the refresh rate is much less relevant. LCD monitors display a stable, flicker-free image at 60Hz. There is no visible differences between 85Hz and 60Hz.

---

**Q:** What are the .inf and .icm files on the setup disk & CD-ROM? How do I install the drivers (.inf and .icm)?

**A:** These are the driver files for your monitor. Follow the instructions in your user manual to install the drivers. You computer may ask you for monitor drivers (.inf and .icm files) or a driver disk when you first install your monitor. Follow the instructions to insert the driver disk (either floppy or CD-ROM) included in this package. Monitor drivers (.inf and .icm files) will be installed automatically.

---

**Q:** How do I adjust resolution?

**A:** Your video card/graphic driver and monitor together determine the available resolutions. You can select desired resolution under Window 95/98 with the "Display properties/Settings" control panel

---

**Q:** What if I get lost when making monitor adjustments?

**A:** Simply press the OSD button, then select "Reset" to recall all original factory settings.

---

**Q:** What is the Auto function?

**A:** The *AUTO adjustment* key restores optimal screen position, phase and clock settings with the press of a single button – without navigation through OSD menus and control keys.

---

**Q:** My Monitor has no power (Power LED does not light) ? What should I do?

**A:** Make sure the AC power cord is connected to the Monitor.

---

**Q:** Will the LCD monitor accept an Interlaced signal?

**A:** No If an Interlace signal is used, the screen displays both odd and even horizontal scanning lines at the same time, distorting the picture.

---

**Q:** Does Refresh Rate mean to LCD?

**A:** Unlike CRT display technology in which the speed the electron beam is swept from the top to the bottom of the screen determines flicker, an active matrix display uses an active element (TFT) to control each individual pixel and thus refresh rate is not really applicable to LCD technology.

---

**Q:** Will the LCD screen resistant scratches?

**A:** A protective coating is applied onto the surface of the LCD, which is durable up to a certain extent of hardness (approximately up to the hardness of a 2H pencil). In general, it is recommended not to expose the panel surface to any excessive shocks or scratches. An optional protective cover with greater scratch resistance is also available.

---

**Q:** How should I clean the LCD surface?

**A:** For normal cleaning, use the clean, soft and fine. For extensive cleaning, please use Isopropyl alcohol. Do not use other solvents such as ethyl alcohol, ethanol, acetone, hexane, etc.

---

**Q:** Can the Philips LCD Monitor be hung on the wall or used as touch panel?

**A:** Yes, Philips Brilliance LCD monitors have this optional feature. The standard VESA mount holes on back cover that allows user to mount the Philips monitor on any VESA standard ARM or accessories. Touch panels are being developed for future applications. Check with your Philips sales representative for more information.

[RETURN TO TOP OF THE PAGE](#)

---

## Screen Adjustments

**Q:** What is the FPadjust program on the setup disk and CD-ROM?

**A:** The FPadjust program generates alignment patterns that help you adjust monitor settings such as Contrast, Brightness, Horizontal Position, Vertical Position, Phase, and Clock for optimal performance.

---

**Q: When I install my monitor, how do I get the best performance for the monitor?**

**A:**

1. For best performance, make sure your display settings are set at 1024x768@60Hz for 14"/15", 1280x1024@60Hz for 17"/18". Note: You can check the current display settings by pressing the OSD OK button once.  
The current display mode is shown in product information in OSD main controls.
  2. To install the Flat Panel Adjust (FPadjust) program located on the monitor setup CD-ROM, open the CD-ROM and double-click the FP\_setup01.exe icon. This will install FP Adjust automatically and place a shortcut on your desktop.
  3. Run FPadjust by double clicking the shortcut. Follow the instructions step by step to optimize image performance with your system's video controller.
- 

**Q: How do LCDs compare to CRTs in terms of radiation?**

**A: Because LCDs do not use an electron gun, they do not generate the same amount of radiation at the screen surface.**

[RETURN TO TOP OF THE PAGE](#)

---

## Compatibility with other Peripherals

**Q: Can I connect my LCD monitor to any PC, workstation or Mac?**

**A: Yes, all Philips LCD monitors are fully compatible with standard PC, Mac and workstation. You may need a cable adapter to connect the monitor to your Mac system. Please contact your dealer/reseller for more information.**

---

**Q: Are Philips LCD monitors Plug-and-Play?**

**A: Yes, the monitors are Plug-and-Play compatible with Windows® 95, 98, 2000 and the PC98/99 platforms.**

---

**Q: What is USB (Universal Serial Bus)?**

**A: Think of USB as a smart plug for PC peripherals. USB automatically determines resources (like driver software and bus bandwidth) required by peripherals. USB makes necessary resources available without user intervention. There are three main benefits of USB. USB eliminates "case angst," the fear of removing the computer case to install circuit board cards -- that often require**

**adjustment of complicated IRQ settings -- for add-on peripherals. USB does away with "port gridlock." Without USB, PCs are normally limited to one printer, two Com port devices (usually a mouse and modem), one Enhanced Parallel Port add-on (scanner or video camera, for example), and a joystick. More and more peripherals for multimedia computers come on the market every day.**

With USB, up to 127 devices can run simultaneously on one computer. USB permits "hot plug-in." No need to shut down, plug in, reboot and run set up to install peripherals. No need to go through the reverse process to unplug a device. Bottom line: USB transforms today's "Plug-and-Pray" into true Plug-and-Play!

---

**Q: What is a USB hub ?**

**A: A USB hub provides additional connections to the Universal Serial Bus. A hub's upstream port connects a hub to the host, usually a PC. Multiple downstream ports in a hub allows connection to another hub or device, such as a USB keyboard, camera or printer.**

[RETURN TO TOP OF THE PAGE](#)

---

## **LCD Panel Technology**

**Q: What is Liquid Crystal Display?**

**A: A Liquid Crystal Display (LCD) is an optical device that is commonly used to display ASCII characters and images on digital items such as watches, calculators, portable game consoles etc. LCD is the technology used for displays in notebook and other small computers. Like light-emitting diode and gas-plasma technologies, LCD allows displays to be much thinner than cathode ray tube (CRT) technology. LCD consumes much less power than LED and gas-display displays because they work on the principle of blocking light rather than emitting it.**

---

**Q: How are LCDs made?**

**A: LCDs are created from two glass plates separated from each other at a distance of a few microns. Plates are filled with liquid crystal, then seals together. The top plate is colored with a RGB pattern to make the color filter. Then polarizers are glued to both plates. This combination is sometimes called "glass" or "cell." The LCD cell is assembled into a "module" by adding the backlight, driver electronics and frame.**

---

**Q: What is polarization ?**

**A: Polarization is basically directing light to shine in one direction. Light is electromagnetic wave. Electric and magnetic fields oscillate in a direction perpendicular to the propagation of the light beam. The direction of these fields is called "polarization direction." Normal or non-polarized light has fields in several directions; polarized light has a field in only one direction.**

**Q:** What differentiates passive matrix LCDs from active matrix LCDs?

**A:** An LCD is made with either a passive matrix or an active matrix display grid. An active matrix has a transistor located at each pixel intersection, requiring less current to control the luminance of a pixel. For this reason, the current in an active matrix display can be switched on and off more frequently, improving the screen refresh time (your mouse pointer will appear to move more smoothly across the screen, for example). The passive matrix LCD has a grid of conductors with pixels located at each intersection in the grid.

---

**Q:** How does a TFT LCD Panel work?

**A:** On each column and row of the TFT LCD panel, a data source drive and a gate drive are attached respectively. The TFT drain of each cell is connected to the electrode. The molecular arrangement of liquid crystal elements differs depending on whether it is impressed with voltage or not. It varies the direction of polarized light and the amount of light by letting it through different arrays of liquid crystal elements. When two polarized filters are arranged vertically on a polarized light pole, the light that passes through the upper polarized panel is turned 90 degrees along with spiral structure of the liquid crystal molecules, and goes through the polarized filter at the bottom. When impressed with voltage, liquid crystal molecules are arranged vertically from the original spiral structure and the direction of the light is not turned in 90 degrees. In this case, light that comes through the top polarized panel may not go through the polarized panel at the bottom.

---

**Q:** What are the advantages of TFT LCD compared to CRT?

**A:** In a CRT monitor, a gun shoots electrons and generates light by colliding polarized electrons on fluorescent glass. Therefore, CRT monitors basically operate with analog RGB signal. A TFT LCD monitor is a device displaying an input image by operating liquid crystal panel. The TFT has a fundamentally different structure than a CRT: Each cell has an active matrix structure and independent active elements. A TFT LCD has two glass panels and the space between them is filled in with liquid crystal. When each cell is connected with electrodes and impressed with voltage, molecular structure of liquid crystal is altered and controls amount of inlet lighting to display images. A TFT LCD has several advantages over a CRT, since it can be very thin and it does not have flickering because it does not use scanning method.

---

**Q:** Vertical frequency of 60Hz optimal for an LCD monitor, why?

**A:** Unlike a CRT monitor, the TFT LCD panel has a fixed resolution. For example, an XGA monitor has 1024x3 (R, G, B) x 768 pixels and higher resolution may not be available without additional software processing. The panel is designed to optimize display for 65MHz dot clock, one of the standards for XGA displays. Since the vertical/horizontal frequency for this dot clock is 60Hz/48KHz, the optimum frequency for this monitor is 60Hz.

---

**Q: What kind of wide-angle technology is available? How does it work?**

**A:** The TFT LCD panel is an element controls/displays inlet of a backlight using the dual-refraction of liquid crystal. Using the property that the projection of inlet light refracts toward the major axis of the liquid element, it controls the direction of inlet light and displays it. Since the refraction ratio of inlet light on liquid crystal varies with the inlet angle of the light, the viewing angle of a TFT is much narrow than that of a CDT. Usually, viewing angle refers to the point where the contrast ration is 10. Many ways to widen the viewing angle are currently being developed the most commonly used approach is to use a wide viewing angle film, which widens viewing angle by varying the refraction ratio. Also IPS (In Plane Switching) or MVA (Multi Vertical Aligned) is used for wider viewing angle.

---

**Q: Why is there no flicker on an LCD Monitor?**

**A:** Technically speaking, LCDs do flicker, but the cause of the phenomenon is different from that of CRT monitor -- and has no impact of ease of viewing. Flickering in a LCD monitor refers to usually undetectable luminance caused by the difference between positive and negative voltage. On the other hand, CRT flickering that can irritate the human eye comes when the on/off action of the florescent object becomes visible. Since the reaction speed of liquid crystal in a LCD panel is much slower, this troublesome form of flickering is not present in LCD display.

---

**Q: Why is an LCD monitor virtually free of Electro Magnetic Interference?**

**A:** Unlike a CRT, an LCD monitor does not have key parts that generate Electro Magnetic Interference, especially magnetic fields. Also, since LCD display utilizes relatively low power, its power supply is extremely quiet.

[RETURN TO TOP OF THE PAGE](#)

---

## **Ergonomics, Ecology, and Safety Standards**

**Q: What is CE mark?**

**A:** The CE (Conformité Européenne) marking is required to be displayed on the regulated product placed for sale on the European market. This mark "CE" means that a product complies with an applicable European Directive. A European Directive is a European "Law" which relates to health, safety, environment and consumer Protection, much the same as the U.S. National Electrical Code and UL Standards.

---

**Q: Does the LCD monitor conform to general safety standards?**

**A: Yes. Philips LCD monitors conform to the guidelines of MPR-II and TCO 95-99 standards for the control of radiation, electromagnetic waves, energy reduction, electrical safety in the work environment, and recyclability. The specification page provides detailed safety standards data.**

*More information is provided in the [Regulatory Information](#) chapter.*



[RETURN TO TOP OF THE PAGE](#)



# Troubleshooting

[Safety and Troubleshooting](#) • [FAQs](#) • [Common Problems](#) • [Imaging Problems](#) • [Regulatory Information](#) • [Other Related Information](#)

This page presents problems that can be corrected by the user. If the problem still exists after these possible solutions, contact your nearest Philips dealer.

<b>Common Problems</b>	
<b>Having this problem?</b>	<b>Check these items</b>
No Picture (Power LED not lit)	<ul style="list-style-type: none"> <li>● Make sure the Power cable is plugged to the wall and the back of the monitor.</li> <li>● First, power button in front of the monitor should be in the OFF position, then press it to ON position again.</li> </ul>
No Picture (Power LED is amber or yellow)	<ul style="list-style-type: none"> <li>● Make sure the computer is turned on.</li> <li>● Make sure the signal cable is properly connected to your computer.</li> <li>● Check to see if the monitor cable has bent pins.</li> <li>● The Energy Saving feature may be activated</li> </ul>
Screen says 	<ul style="list-style-type: none"> <li>● Make sure the monitor cable is properly connected to your computer. (Also refer to the Quick Set Up Guide).</li> <li>● Check to see if the monitor cable has bent pins.</li> <li>● Make sure the computer is turned on.</li> </ul>
Screen says 	<ul style="list-style-type: none"> <li>● Make sure the vertical sync of input signal is within the range of 56 ~ 75 Hz.</li> <li>● Change the refresh rate to 56~75Hz within 10 minutes.</li> <li>● Re-power on monitor to start over again if you failed to change the refresh rate within 10 minutes.</li> </ul>
AUTO button not working properly	<ul style="list-style-type: none"> <li>● The Auto Function is designed for use on standard Macintosh or IBM-compatible PC running Microsoft properly Windows.</li> <li>● It may not work properly if using nonstandard PCs or video card.</li> </ul>
<b>Imaging Problems</b>	
Display position is incorrect	<ul style="list-style-type: none"> <li>● Push the Auto button.</li> <li>● Adjust the image position using the Horizontal Position &amp;/or Vertical Position in OSD Main Controls.</li> </ul>
Image vibrates on the screen	<ul style="list-style-type: none"> <li>● Check that the signal cable is properly connected to the graphics board or PC.</li> </ul>
Vertical flicker appears 	<ul style="list-style-type: none"> <li>● Push the Auto button.</li> <li>● Eliminate the vertical bars using the Clock Adjustment of VIDEO NOISE in OSD Main Controls.</li> </ul>

Horizontal flicker appears



- Push the Auto button.
- Eliminate the horizontal bars using the Phase Adjustment of VIDEO NOISE in OSD Main Controls.

The screen is too bright or too dark

- Adjust the contrast and brightness in OSD Main Controls. (The backlight of the LCD monitor has a fixed life span. When the screen becomes dark or begins to flicker, please contact your dealer.

An after-image appears

- If an image remains in the screen for an extended period of time, it may be imprinted in the screen and leave an afterimage This usually disappears after a few hours

An afterimage remains after the power has been turned off.

- This is characteristic of liquid crystal and is not caused by a malfunction or deterioration of the liquid crystal. The afterimage will disappear after a set amount of time

Green, red, blue, dark, and white dots remains

- The remaining dots are normal characteristic of the liquid crystal used in today's technology.

For further assistance, refer to the [Consumer Information Centers](#) list to contact your local Philips distributor.

[RETURN TO TOP OF THE PAGE](#)

# Regulatory Information

[TCO '99 Information](#) • [TCO Environmental Requirements](#) • [Energy Star Declaration](#) • [Federal Communications Commission \(FCC\) Notice \(U.S. Only\)](#) • [Commission Federale de la Communication \(FCC Declaration\)](#) • [EN 55022 Compliance \(Czech Republic Only\)](#) • [VCCI Class 2 Notice \(Japan Only\)](#) • [MIC Notice \(South Korea Only\)](#) • [Polish Center for Testing and Certification Notice](#) • [North Europe Information](#) • [BSMI Notice \(Taiwan Only\)](#) • [Ergonomie Hinweis \(nur Deutschland\)](#) • [Philips End-of-Life Disposal](#) • [Information for UK only](#)

[Safety and Troubleshooting](#) • [Troubleshooting](#) • [Other Related Information](#) • [Frequently Asked Questions \(FAQs\)](#)

---

## TCO '99 Information



**Congratulations!** You have just purchased a TCO '99 approved and labeled product! Your choice has provided you with a product developed for professional use. Your purchase has also contributed to reducing the burden on the environment and also to the further development of environmentally adapted electronics products.

### *Why do we have environmentally labeled computers?*

In many countries, environmental labeling has become an established method for encouraging the adaptation of goods and services to the environment. The main problem, as far as computers and other electronics equipment are concerned, is that environmentally harmful substances are used both in the products and during their manufacture. Since it is not so far possible to satisfactorily recycle the majority of electronics equipment, most of these potentially damaging substances sooner or later enter nature.

There are also other characteristics of a computer, such as energy consumption levels, that are important from the viewpoints of both the work (internal) and natural (external) environments. Since all methods of electricity generation have a negative effect on the environment (e.g. acidic and climate-influencing emissions, radioactive waste), it is vital to save energy. Electronics equipment in offices is often left running continuously and thereby consumes a lot of energy.

### *What does labeling involve?*

This product meets the requirements for the TCO'99 scheme which provides for international and environmental labeling of personal computers. The labeling scheme was developed as a joint effort by the TCO (The Swedish Confederation of Professional Employees), Svenska Naturskyddsforeningen (The Swedish Society for Nature Conservation) and Statens Energimyndighet (The Swedish National Energy Administration).

Approval requirements cover a wide range of issues: environment, ergonomics, usability, emission of electric and magnetic fields, energy consumption and electrical and fire safety.

The environmental demands impose restrictions on the presence and use of heavy metals, brominated and chlorinated flame retardants, CFCs (freons) and chlorinated solvents, among other things. The product must be prepared for recycling and the manufacturer is obliged to have an environmental policy which must be adhered to in each country where the company implements its operational policy.

The energy requirements include a demand that the computer and/or display, after a certain period of inactivity, shall reduce its power consumption to a lower level in one or more stages. The length of time to reactivate the computer shall be reasonable for the user.

Labeled products must meet strict environmental demands, for example, in respect of the reduction of electric and magnetic fields, physical and visual ergonomics and good usability.

Below you will find a brief summary of the environmental requirements met by this product. The complete environmental criteria document may be ordered from:

TCO Development

SE-114 94 Stockholm, Sweden

Fax: +46 8 782 92 07

Email (Internet): [development@tco.se](mailto:development@tco.se)

*Current information regarding TCO'99 approved and labeled products may also be obtained via the Internet, using the address: <http://www.tco-info.com/>*

[RETURN TO TOP OF THE PAGE](#)

---

## Environmental Requirements

### *Flame retardants*

Flame retardants are present in printed circuit boards, cables, wires, casings and housings. Their purpose is to prevent, or at least to delay the spread of fire. Up to 30% of the plastic in a computer casing can consist of flame retardant substances. Most flame retardants contain bromine or chloride, and those flame retardants are chemically related to another group of environmental toxins, PCBs. Both the flame retardants containing bromine or chloride and the PCBs are suspected of giving rise to severe health effects, including reproductive damage in fish-eating birds and mammals, due to the bio-accumulative\* processes. Flame retardants have been found in human blood and researchers fear that disturbances in fetus development may occur.

The relevant TCO'99 demand requires that plastic components weighing more than 25 grams must not contain flame retardants with organically bound bromine or chlorine. Flame retardants are allowed in the printed circuit boards since no substitutes are available.

### **Cadmium\*\***

Cadmium is present in rechargeable batteries and in the color-generating layers of certain computer displays. Cadmium damages the nervous system and is toxic in high doses. The relevant TCO'99 requirement states that batteries, the color-generating layers of display screens and the electrical or electronics components must not contain any cadmium.

### **Mercury\*\***

Mercury is sometimes found in batteries, relays and switches. It damages the nervous system and is toxic in high doses. The relevant TCO'99 requirement states that batteries may not contain any mercury. It also demands that mercury is not present in any of the electrical or electronics components associated with the labeled unit.

**CFCs (freons)**

The relevant TCO'99 requirement states that neither CFCs nor HCFCs may be used during the manufacture and assembly of the product. CFCs (freons) are sometimes used for washing printed circuit boards. CFCs break down ozone and thereby damage the ozone layer in the stratosphere, causing increased reception on earth of ultraviolet light with increased risks e.g. skin cancer (malignant melanoma) as a consequence.

**Lead\*\***

Lead can be found in picture tubes, display screens, solders and capacitors. Lead damages the nervous system and in higher doses, causes lead poisoning. The relevant TCO'99 requirement permits the inclusion of lead since no replacement has yet been developed.

**\* Bio-accumulative is defined as substances which accumulate within living organisms.**

**\*\* Lead, Cadmium and Mercury are heavy metals which are bio-accumulative.**

[RETURN TO TOP OF THE PAGE](#)

**Energy Star Declaration**

**PHILIPS  
150B2B**

This monitor is equipped with a function for saving energy which supports the VESA Display Power Management Signaling (DPMS) standard. This means that the monitor must be connected to a computer which supports VESA DPMS to fulfill the requirements in the NUTEK specification 803299/94. Time settings are adjusted from the system unit by software. From indicated inactivity to Power Saving Position A2, the total time must not be set to more than 70 minutes.

NUTEK	VESA State	LED Indicator	Power Consumption
Normal operation	ON	Green	< 23 W
Power Saving Position A1	Suspend	Amber	< 3 W
Power Saving Position A2	OFF	Amber	< 3 W



As an ENERGY STAR® Partner, PHILIPS has determined that this product meets the ENERGY STAR® guidelines for energy efficiency.



We recommend you switch off the monitor when it is not in use for quite a long time.

[RETURN TO TOP OF THE PAGE](#)

---

## Federal Communications Commission (FCC) Notice (U.S. Only)



This equipment has been tested and found to comply with the limits for a Class B digital device, pursuant to Part 15 of the FCC Rules. These limits are designed to provide reasonable protection against harmful interference in a residential installation. This equipment generates, uses and can radiate radio frequency energy and, if not installed and used in accordance with the instructions, may cause harmful interference to radio communications. However, there is no guarantee that interference will not occur in a particular installation. If this equipment does cause harmful interference to radio or television reception, which can be determined by turning the equipment off and on, the user is encouraged to try to correct the interference by one or more of the following measures:

- Reorient or relocate the receiving antenna.
- Increase the separation between the equipment and receiver.
- Connect the equipment into an outlet on a circuit different from that to which the receiver is connected.
- Consult the dealer or an experienced radio/TV technician for help.



Changes or modifications not expressly approved by the party responsible for compliance could void the user's authority to operate the equipment.

Use only RF shielded cable that was supplied with the monitor when connecting this monitor to a computer device.

To prevent damage which may result in fire or shock hazard, do not expose this appliance to rain or excessive moisture.

THIS CLASS B DIGITAL APPARATUS MEETS ALL REQUIREMENTS OF THE CANADIAN INTERFERENCE-CAUSING EQUIPMENT REGULATIONS.

[RETURN TO TOP OF THE PAGE](#)

---

## Commission Federale de la Communication (FCC Declaration)



Cet équipement a été testé et déclaré conforme aux limites des appareils numériques de class B, aux termes de l'article 15 Des règles de la FCC. Ces limites sont conçues de façon à fournir une protection raisonnable contre les interférences nuisibles dans le cadre d'une installation résidentielle. CET appareil produit, utilise et peut émettre des hyperfréquences qui, si l'appareil n'est pas installé et utilisé selon les consignes données, peuvent causer des interférences nuisibles aux communications radio. Cependant, rien ne peut garantir l'absence d'interférences dans le cadre d'une installation particulière. Si cet appareil est la cause d'interférences nuisibles pour la réception des signaux de radio ou de télévision, ce qui peut être décelé en fermant l'équipement, puis en le remettant en fonction, l'utilisateur pourrait essayer de corriger la situation en prenant les mesures suivantes:

- Réorienter ou déplacer l'antenne de réception.
- Augmenter la distance entre l'équipement et le récepteur.
- Brancher l'équipement sur un autre circuit que celui utilisé par le récepteur.
- Demander l'aide du marchand ou d'un technicien chevronné en radio/télévision.



Toutes modifications n'ayant pas reçu l'approbation des services compétents en matière de conformité est susceptible d'interdire à l'utilisateur l'usage du présent équipement.

N'utiliser que des câbles RF armés pour les connections avec des ordinateurs ou périphériques.

CET APPAREIL NUMERIQUE DE LA CLASSE B RESPECTE TOUTES LES EXIGENCES DU REGLEMENT SUR LE MATERIEL BROUILLEUR DU CANADA.

[RETURN TO TOP OF THE PAGE](#)

---

## EN 55022 Compliance (Czech Republic Only)

This device belongs to category B devices as described in EN 55022, unless it is specifically stated that it is a Class A device on the specification label. The following applies to devices in Class A of EN 55022 (radius of protection up to 30 meters). The user of the device is obliged to take all steps necessary to remove sources of interference to telecommunication or other devices.

Pokud není na typovém štítku počítače uvedeno, že spadá do třídy A podle EN 55022, spadá automaticky do třídy B podle EN 55022. Pro zařízení zařazená do třídy A (chranné pásmo 30m) podle EN 55022 platí následující. Dojde-li k rušení telekomunikačních nebo jiných zařízení je uživatel povinen provést taková opatření, aby rušení odstranil.

[RETURN TO TOP OF THE PAGE](#)

---

## VCCI Notice (Japan Only)

This is a Class B product based on the standard of the Voluntary Control Council for Interference (VCCI) for

Information technology equipment. If this equipment is used near a radio or television receiver in a domestic environment, it may cause radio Interference. Install and use the equipment according to the instruction manual.



Class B ITE

この装置は、情報処理装置等電波障害自主規制協議会 (VCCI) の基準に基づくクラス B 情報技術装置です。この装置は家庭環境で使用することを目的としていますが、この装置がラジオやテレビジョン受信機に近接して使用されると、受信障害を引き起こすことがあります。取扱説明書に従って正しい取り扱いをして下さい。

[RETURN TO TOP OF THE PAGE](#)

## MIC Notice (South Korea Only)

Class B Device

장치 종류	사용자 안내문
B급 기기	이 장치는 가정용으로 전자파 적합등록을 한 장치로서 주거지역에서는 물론 모든 지역에서 사용할 수 있습니다.



Please note that this device has been approved for non-business purposes and may be used in any environment, including residential areas.



## Polish Center for Testing and Certification Notice

The equipment should draw power from a socket with an attached protection circuit (a three-prong socket). All equipment that works together (computer, monitor, printer, and so on) should have the same power supply source.

The phasing conductor of the room's electrical installation should have a reserve short-circuit protection device in the form of a fuse with a nominal value no larger than 16 amperes (A).

To completely switch off the equipment, the power supply cable must be removed from the power supply socket, which should be located near the equipment and easily accessible.

A protection mark "B" confirms that the equipment is in compliance with the protection usage requirements of standards PN-93/T-42107 and PN-89/E-06251.

### ***Wymagania Polskiego Centrum Badań i Certyfikacji***

Urządzenie powinno być zasilane z gniazda z przyłączonym obwodem ochronnym (gniazdo z kolkiem). Współpracujące ze sobą urządzenia (komputer, monitor, drukarka) powinny być zasilane z tego samego źródła.

Instalacja elektryczna pomieszczenia powinna zawierać w przewodzie fazowym rezerwową ochronę przed zwarciami, w postaci bezpiecznika o wartości znamionowej nie większej niż 16A (amperów).

W celu całkowitego wyłączenia urządzenia z sieci zasilania, należy wyjąć wtyczkę kabla zasilającego z gniazdka, które powinno znajdować się w pobliżu urządzenia i być łatwo dostępne.

Znak bezpieczeństwa "B" potwierdza zgodność urządzenia z wymaganiami bezpieczeństwa użytkowania zawartymi w PN-93/T-42107 i PN-89/E-06251.

### ***Pozostałe instrukcje bezpieczeństwa***

- Nie należy używać wtyczek adapterowych lub usuwać kolka obwodu ochronnego z wtyczki. Jeżeli konieczne jest użycie przedłużacza to należy użyć przedłużacza 3-żyłowego z prawidłowo połączonym przewodem ochronnym.
- System komputerowy należy zabezpieczyć przed nagłymi, chwilowymi wzrostami lub spadkami napięcia, używając eliminatora przepięć, urządzenia dopasowującego lub bezzakłócenowego źródła zasilania.
- Należy upewnić się, aby nie leżało na kablach systemu komputerowego, oraz aby kable nie były umieszczone w miejscu, gdzie można byłoby na nie nadeptywać lub potykać się o nie.
- Nie należy rozlewać napojów ani innych płynów na system komputerowy.
- Nie należy wypychać żadnych przedmiotów do otworów systemu komputerowego, gdyż może to spowodować pożar lub porażenie prądem, poprzez zwarcie elementów wewnętrznych.
- System komputerowy powinien znajdować się z dala od grzejników i źródeł ciepła. Ponadto, nie należy blokować otworów wentylacyjnych. Należy unikać kładzenia luźnych papierów pod komputer oraz umieszczania komputera w ciasnym miejscu bez możliwości cyrkulacji powietrza wokół niego.

## North Europe Information

## Placering/Ventilation

### **VARNING:**

FÖRSÄKRA DIG OM ATT HUVUDBRYTARE OCH UTTAG ÄR LÄTÅTKOMLIGA, NÄR DU STÄLLER DIN UTRUSTNING PÅPLATS.

## Placering/Ventilation

### **ADVARSEL:**

SØRG VED PLACERINGSFOR, AT NETLEDNINGENS STIK OG STIKKONTAKT ER NEMT TILGÆNGELIGE.

## Paikka/Ilmankierto

### **VAROITUS:**

SIJOITA LAITE SITEN, ETTÄ VERKKOJOHTO VOIDAAN TARVITTAESSA HELPOSTI IRROTTAA PISTORASIESTA.

## Plassering/Ventilasjon

### **ADVARSEL:**

NÅR DETTE UTSTYRET PLASSERES, MÅ DU PASSE PÅ AT KONTAKTENE FOR STØMTILFØRSEL ER LETTE Å NÅ.

[RETURN TO TOP OF THE PAGE](#)

---

## **BSMI Notice (Taiwan Only)**

符合乙類資訊產品之標準

[RETURN TO TOP OF THE PAGE](#)

---

## Ergonomie Hinweis (nur Deutschland)

Der von uns gelieferte Farbmonitor entspricht den in der "Verordnung über den Schutz vor Schäden durch Röntgenstrahlen" festgelegten Vorschriften.

Auf der Rückwand des Gerätes befindet sich ein Aufkleber, der auf die Unbedenklichkeit der Inbetriebnahme hinweist, da die Vorschriften über die Bauart von Störstrahlern nach Anlage III  $\alpha$  5 Abs. 4 der Röntgenverordnung erfüllt sind.

Damit Ihr Monitor immer den in der Zulassung geforderten Werten entspricht, ist darauf zu achten, daß

1. Reparaturen nur durch Fachpersonal durchgeführt werden.
2. nur original-Ersatzteile verwendet werden.
3. bei Ersatz der Bildröhre nur eine bauartgleiche eingebaut wird.

Aus ergonomischen Gründen wird empfohlen, die Grundfarben Blau und Rot nicht auf dunklem Untergrund zu verwenden (schlechte Lesbarkeit und erhöhte Augenbelastung bei zu geringem Zeichenkontrast wären die Folge).

Der arbeitsplatzbezogene Schalldruckpegel nach DIN 45 635 beträgt 70dB (A) oder weniger.



**ACHTUNG: BEIM AUFSTELLEN DIESES GERÄTES DARAUFGAHTEN, DAß NETZSTECKER UND NETZKABELANSCHLUß LEICHT ZUGÄNGLICH SIND.**

[RETURN TO TOP OF THE PAGE](#)

---

## End-of-Life Disposal

Your new monitor contains materials that can be recycled and reused. Specialized companies can recycle your product to increase the amount of reusable materials and to minimize the amount to be disposed of.

Please find out about the local regulations on how to dispose of your old monitor from your local Philips dealer.

[RETURN TO TOP OF THE PAGE](#)

---

## Information for UK only

**WARNING - THIS APPLIANCE MUST BE EARTHED.**

**Important:**

This apparatus is supplied with an approved moulded 13A plug. To change a fuse in this type

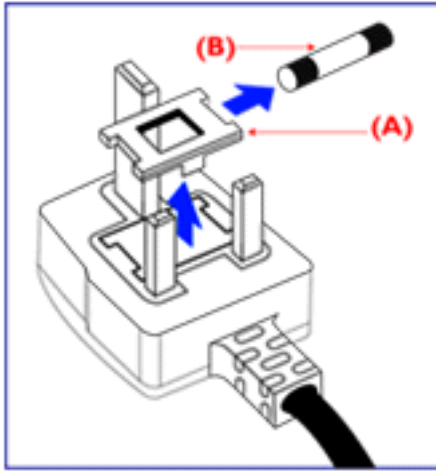

of plug proceed as follows:

1. Remove fuse cover and fuse.
2. Fit new fuse which should be a BS 1362 5A, A.S.T.A. or BSI approved type.
3. Refit the fuse cover.

If the fitted plug is not suitable for your socket outlets, it should be cut off and an appropriate 3-pin plug fitted in its place.

If the mains plug contains a fuse, this should have a value of 5A. If a plug without a fuse is used, the fuse at the distribution board should not be greater than 5A.

Note: The severed plug must be destroyed to avoid a possible shock hazard should it be inserted into a 13A socket elsewhere.

### How to connect a plug

The wires in the mains lead are coloured in accordance with the following code:

BLUE - "NEUTRAL" ("N")

BROWN - "LIVE" ("L")

GREEN & YELLOW - "EARTH" ("E")

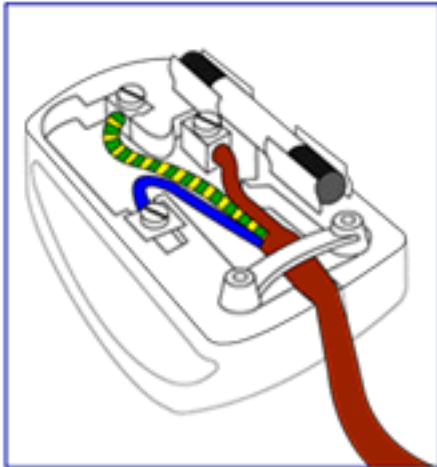

1. The GREEN AND YELLOW wire must be connected to the terminal in the plug which is marked with the letter "E" or by the Earth symbol  $\perp$  or coloured GREEN or GREEN AND YELLOW.

2. The BLUE wire must be connected to the terminal which is marked with the letter "N" or coloured BLACK.

3. The BROWN wire must be connected to the terminal which marked with the letter "L" or coloured RED.

Before replacing the plug cover, make certain that the cord grip is clamped over the sheath of

the lead - not simply over the three wires.

[RETURN TO TOP OF THE PAGE](#)

# Other Related Information

[Safety and Troubleshooting](#) • [FAQs](#) • [Troubleshooting](#) • [Regulatory Information](#) • [Information for Users in the U. S.](#) • [Information for Users Outside the U.S](#)

---

## Information for Users in the U. S.

*For units set at 115 V :*

Use a UL Listed Cord Set consisting of a minimum 18 AWG, Type SVT or SJT three conductor cord a maximum of 15-feet long and a parallel blade, grounding type attachment plug rated 15 A, 125 V.

*For units set at 230 V:*

Use a UL Listed Cord Set consisting of a minimum 18 AWG, Type SVT or SJT three conductor cord a maximum of 15-feet long and a tandem blade, grounding type attachment plug rated 15 A, 250 V.

---

## Information for Users outside the U.S.

*For units set at 230 V:*

Use a Cord Set consisting of a minimum 18 AWG cord and grounding type attachment plug rated 15 A, 250 V. The Cord Set should have the appropriate safety approvals for the country in which the equipment will be installed and / or be marked HAR.

[RETURN TO TOP OF THE PAGE](#)

# Philips Pixel Defect Policy

[Product Features](#) • [Technical Specifications](#) • [Resolution & Preset Modes](#) • [Automatic Power Saving](#) • [Physical Specification](#) • [Pin Assignment](#) • [Product Views](#)

## Philips' Flat Panel Monitors Pixel Defect Policy

Philips strives to deliver the highest quality products. We use some of the industry's most advanced manufacturing processes and practice stringent quality control. However, pixel or subpixel defects on the TFT LCD panels used in flat panel monitors are sometimes unavoidable. No manufacturer can guarantee that all panels will be free from pixel defects, but Philips guarantees that any monitor with an unacceptable number of defects will be repaired or replaced under warranty. This notice explains the different types of pixel defects and defines acceptable defect levels for each type. In order to qualify for repair or replacement under warranty, the number of pixel defects on a TFT LCD panel must exceed these acceptable levels. For example, no more than 0.0004% of the subpixels on a 15" XGA monitor may be defective. Additionally, because some types or combinations of pixel defects are more noticeable than others, Philips sets even higher quality standards for those.

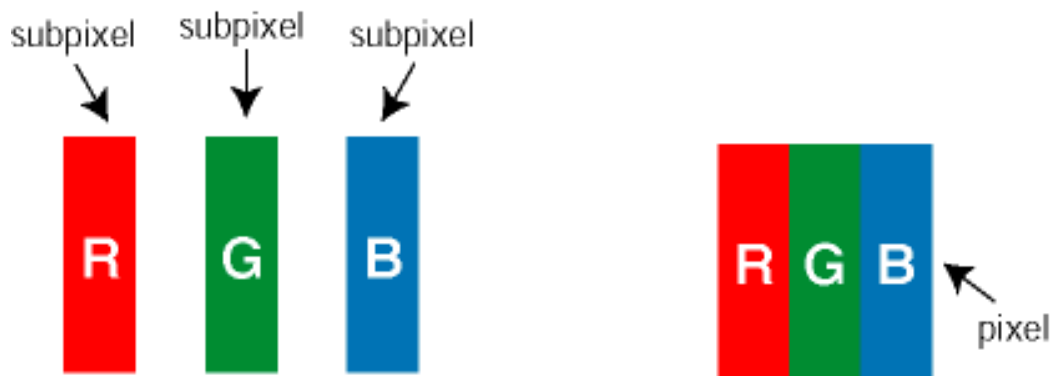

### Pixels and Subpixels

A pixel, or picture element, is composed of three subpixels in the primary colors of red, green and blue. Many pixels together form an image. When all subpixels of a pixel are lit, the three colored subpixels together appear as a single white pixel. When all are dark, the three colored subpixels together appear as a single black pixel. Other combinations of lit and dark subpixels appear as single pixels of other colors.

### Types of Pixel Defects

Pixel and subpixel defects appear on the screen in different ways. There are two categories of pixel defects and several types of subpixel defects within each category.

**Bright Dot Defects** Bright dot defects appear as pixels or subpixels that are always lit or "on". These are the types of bright dot defects:

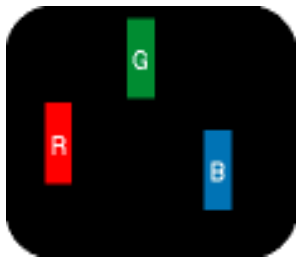

One lit red, green or blue subpixel

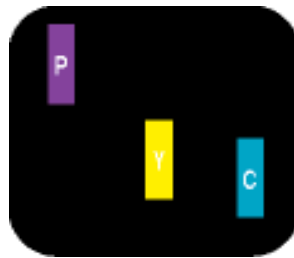

Two adjacent lit subpixels:  
 - Red + Blue = Purple  
 - Red + Green = Yellow  
 - Green + Blue = Cyan (Light Blue)

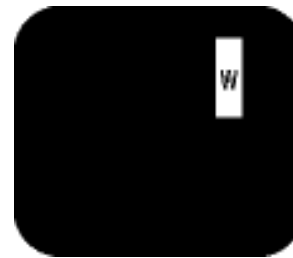

Three adjacent lit subpixels (one white pixel)

**Black Dot Defects** Black dot defects appear as pixels or subpixels that are always dark or "off". These are the types of black dot defects:

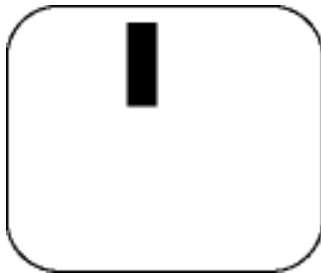

One dark subpixel

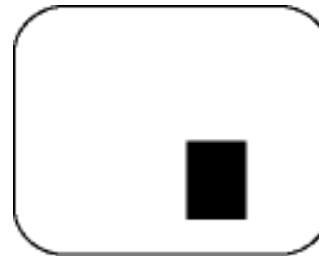

Two or three adjacent dark subpixels

### Proximity of Pixel Defects

Because pixel and subpixels defects of the same type that are nearby one another may be more noticeable, Philips also specifies tolerances for the proximity of pixel defects.

### Pixel Defect Tolerances

In order to qualify for repair or replacement due to pixel defects during the warranty period, a TFT LCD panel in a Philips flat panel monitor must have pixel or subpixel defects exceeding the tolerances listed in the following tables.

BRIGHT DOT DEFECTS	ACCEPTABLE LEVEL		
	150P2	150B2	150S2
MODEL			
1 lit subpixel	0	0	8 or fewer
2 adjacent lit subpixels	0	0	3 or fewer
3 adjacent lit subpixels (one white pixel)	0	0	1 or fewer
Distance between two bright dot defects*	0	0	15 mm or more
Bright dot defects within 20 mm circle	0	0	3 or fewer
Total bright dot defects of all types	0	0	8 or fewer



<b>BLACK DOT DEFECTS</b>	<b>ACCEPTABLE LEVEL</b>		
<i>MODEL</i>	<b>150P2</b>	<b>150B2</b>	<b>150S2</b>
1 dark subpixel	4 or fewer	4 or fewer	8 or fewer
2 adjacent dark subpixels	1 or fewer	1 or fewer	3 or fewer
3 adjacent dark subpixels	0	0	1 or fewer
Distance between two black dot defects*	15 mm or more	15 mm or more	15 mm or more
Black dot defects within 20 mm circle*	3 or fewer	3 or fewer	3 or fewer
Total black dot defects of all types	4 or fewer	4 or fewer	8 or fewer

<b>TOTAL DOT DEFECTS</b>	<b>ACCEPTABLE LEVEL</b>		
<i>MODEL</i>	<b>150P2</b>	<b>150B2</b>	<b>150S2</b>
Total bright or black dot defects of all types	4 or fewer	4 or fewer	10 or fewer

*Note: 1 or 2 adjacent subpixel defects = 1 dot defect*





[RETURN TO TOP OF THE PAGE](#)

# Connecting to Your PC

**Your LCD Monitor :** [Front View Product Description](#) • [Accessory Pack](#) • [Connecting to Your PC](#) • [Getting Started](#) • [Optimizing Performance](#) • [Accessories \(optional\)](#)

## Accessory Pack

Unpack all the parts.

Item	Description	150P2E 150P2D	150P2M 150P2G	150B2B	150S2B	150S2P
	<b>1)</b> Audio in Cable (Option only available for Audio version)(color lime)		V			
	<b>2)</b> Microphone out Cable (Option only available for Audio version)(color pink)		V			
	<b>3)</b> Power Cable (socket may differ for different countries)	V	V	V	V	V
	<b>4)</b> Macintosh Adapter (optional)	V	V	V	V	V
	<b>5)</b> VGA Signal Cable	V	V	V	V	V

	<p><b>6)</b> E-DFU package with Quick Setup Guide, Using Your Monitor Manual, and CD-ROM.</p>	v	v	v	v	v
---	---	---	---	---	---	---

[RETURN TO TOP OF THE PAGE](#)

## Connecting to Your PC

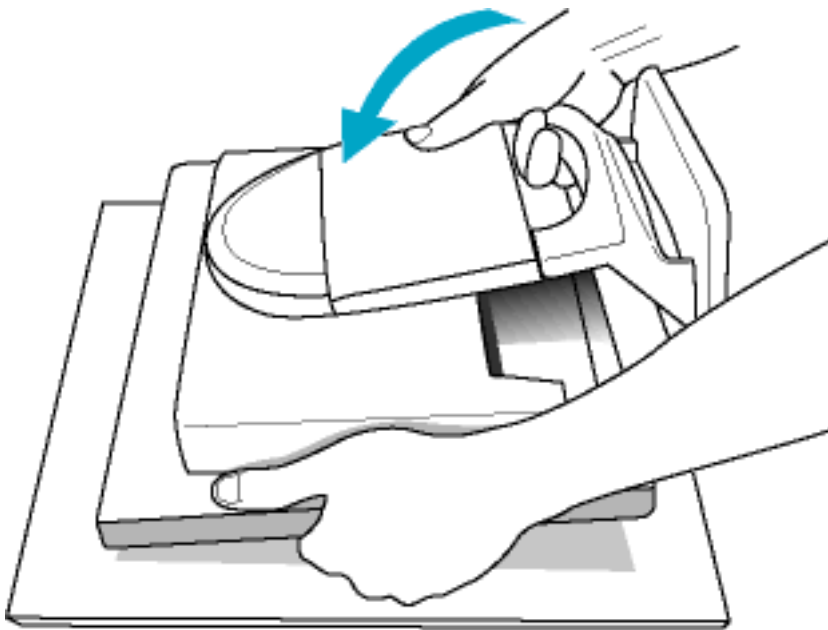

Safe surface

- 1)** Put monitor face down on the safe surface.

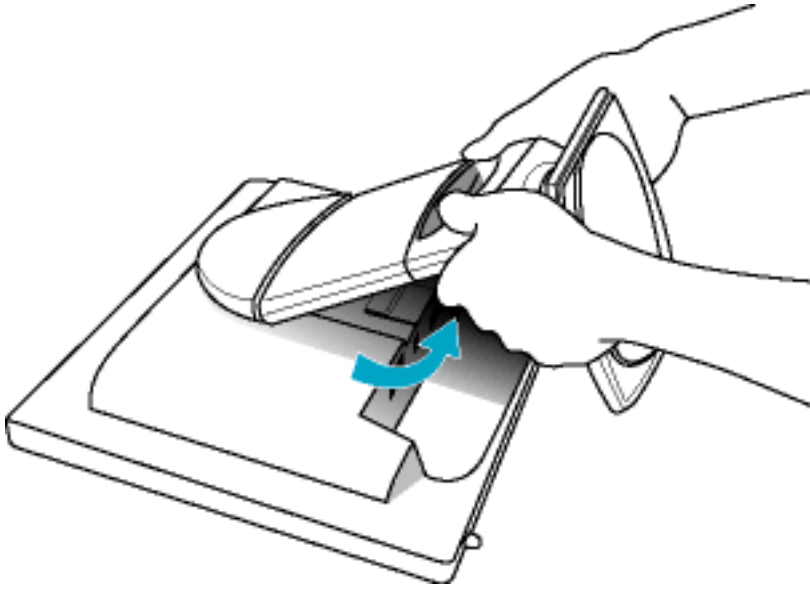

**2)** Tilt the base fully away from the monitor body.

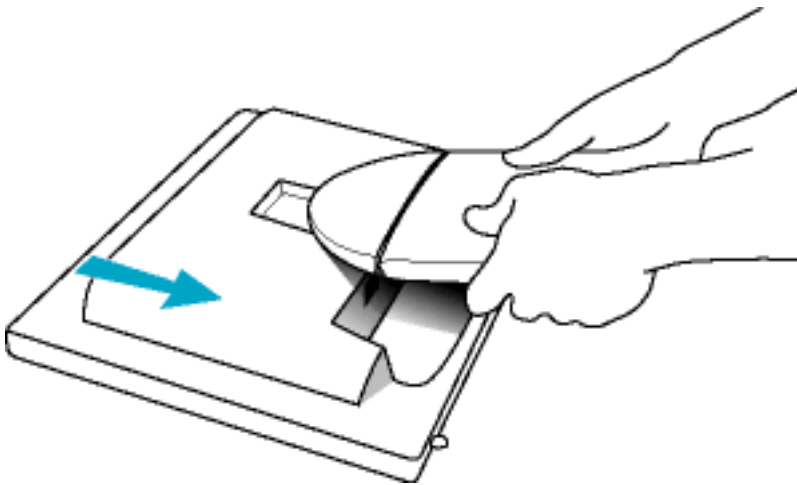

**3)** Pull out and slide away the base from the monitor body.

**4)** Plug in the cables into connectors.

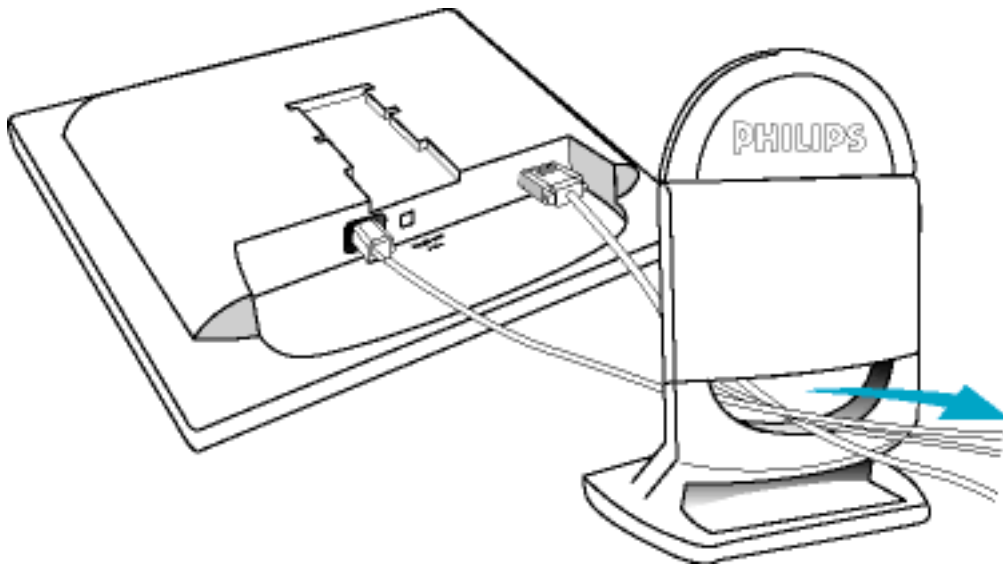
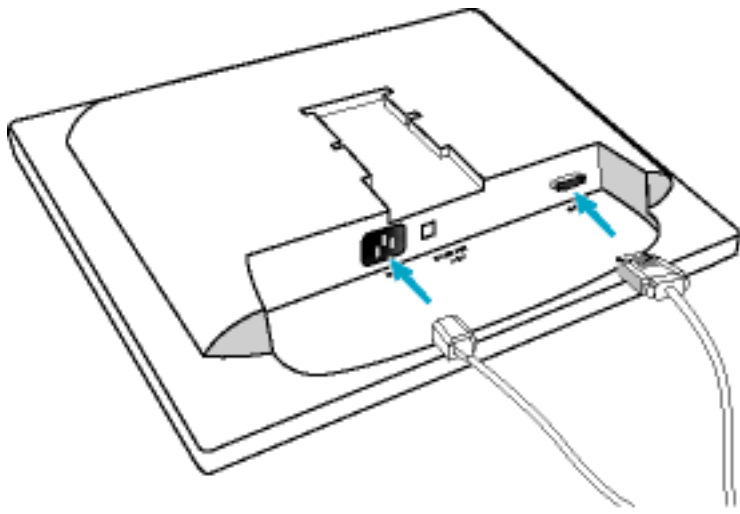

**5)** Thread all cables through the hole at the bottom of the stand.

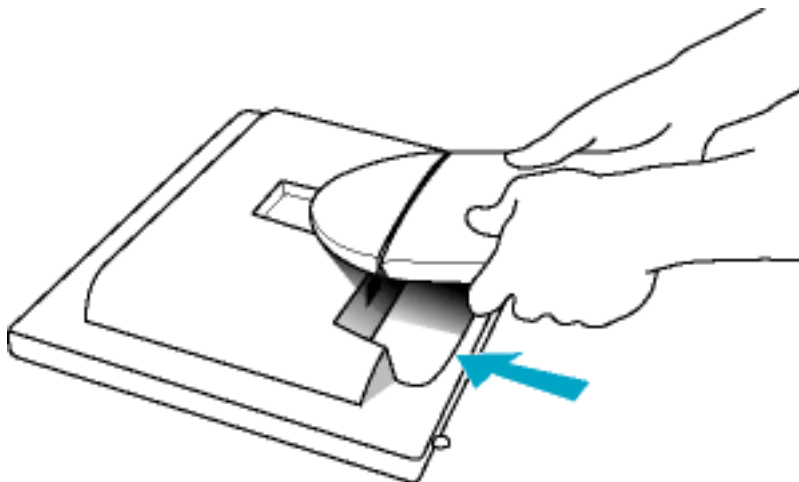

**6)** Locate the base and slide it into monitor body.

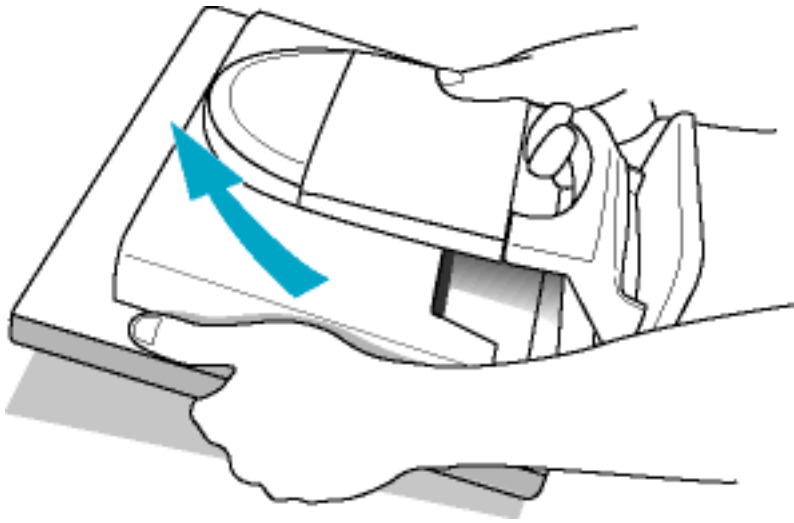

7) Pull back up the monitor body.

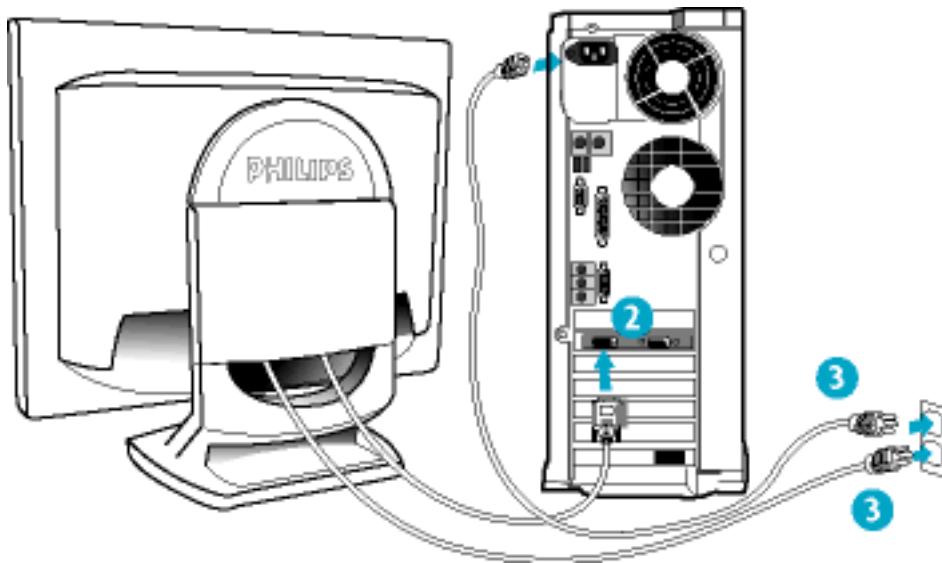

## 8) Connect to PC

- (1) Turn off your computer and unplug its power cable.
- (2) Connect the monitor signal cable to the video connector on the back of your computer.
- (3) Plug the power cord of your computer and your monitor into a nearby outlet.
- (4) Turn on your computer and monitor. If the monitor displays an image, installation is complete.

[RETURN TO TOP OF THE PAGE](#)

# Getting Started

**Your LCD Monitor** : [Front View Product Description](#) • [Connecting to Your PC](#) • [Getting Started](#) • [Optimizing Performance](#) • [Accessories \(optional\)](#)

---

## Getting Started

### Use the information file ( .inf) for Windows 95/98/2000/Me/XP or later

Philips' monitors built in VESA DDC2B feature to support Plug & Play requirements for Windows 95/98/2000/Me/XP. In order to enable your Philips monitor from the "Monitor" dialog box in Windows 95/98/2000/Me/XP and activate Plug & Play application You should install this information file ( .inf). The installation procedure based on Windows '95 OEM Release 2 , 98 , Me, XP and 2000 is specified as follows.

#### For Windows 95

1. Start Windows '95
2. Click the 'Start' button, point to 'Settings', and then click 'Control Panel'.
3. Double Click the 'Display' Icon.
4. Choose the 'Settings' tab then click 'Advanced...'
5. Choose 'Monitor' button, point to 'Change...' then click 'Have Disk...'
6. Click 'Browse...' button then choose the appropriate drive F: ( CD-ROM Drive) then click 'OK' button.
7. Click the 'OK' button then choose your monitor model and click the 'OK'.
8. Click 'Close' button.

#### For Windows 98

1. Start Windows 98
2. Click the 'Start' button, point to 'Settings', and then click 'Control Panel'.
3. Double Click the 'Display' Icon.
4. Choose the 'Settings' tab then click 'Advanced...'
5. Choose 'Monitor' button, point to 'Change...' then click 'Next'
6. Choose "Display a list of all the drivers in a specific location, so you can select the driver you want." then click 'Next' and then click 'Have Disk...'
7. Click 'Browse...' button then choose the appropriate drive F: ( CD-ROM Drive) then click 'OK' button.
8. Click the 'OK' button then choose your monitor model and click the 'Next' button then click 'Next' button.
9. Click 'Finish' button then the 'Close' button.

#### For Windows Me



1. Start Windows Me
2. Click the 'Start' button, point to 'Settings', and then click 'Control Panel'.
3. Double Click the 'Display' Icon.
4. Choose the 'Settings' tab then click 'Advanced...'
5. Choose 'Monitor' button, then click 'Change...' button.
6. Choose "Specify the location of the driver(Advanced)" and click the 'Next' button.
7. Choose "Display a list of all the drivers in a specific location, so you can select the driver you want." then click 'Next' and then click 'Have Disk...'
8. Click 'Browse...' button then choose the appropriate drive F: ( CD-ROM Drive) then click 'OK' button.
9. Click the 'OK' button then choose your monitor model and click the 'Next' button then click 'Next' button.
10. Click 'Finish' button then the 'Close' button.

### For Windows 2000

1. Start Windows 2000
2. Click the 'Start' button, point to 'Settings', and then click 'Control Panel'.
3. Double Click the 'Display' Icon.
4. Choose the 'Settings' tab then click 'Advanced...'
5. Choose 'Monitor' - If the 'Properties' button is inactive, it means your monitor is properly configured. Please stop installation. - If the 'Properties' button is active. Click 'Properties' button. Please follow next steps.
6. Click 'Driver' and then click on 'Update Driver...' then click on the 'Next' button.
7. Choose "Display a list of the known drivers for this device so that I can choose a specific driver" then click 'Next' and then click 'Have disk...'
8. Click 'Browse...' button then choose the appropriate drive F: ( CD-ROM Drive).
9. Click the 'Open' button, then click the 'OK' button.
10. Choose your monitor model and click the 'Next' button then click 'Next' button.
11. Click 'Finish' button then the 'Close' button. If you can see the "Digital Signature Not Found" window then click the 'Yes' button.

### For Windows XP

1. Start Windows XP
2. Click the 'Start' button and then click 'Control Panel'.
3. Pick and click the category 'Printers and Other Hardware'
4. Click the 'Display' Item.
5. Choose the 'Settings' tab then click 'Advanced' button.
6. Choose 'Monitor' tab
  - If the 'Properties' button is inactive, it means your monitor is properly configured. Please stop installation.
  - If the 'Properties' button is active. Click 'Properties' button. Please follow next steps accordingly.
7. Click the 'Driver' tab and then click on 'Update Driver...' button.
8. Choose the 'Install from a list or specific location [advanced]' radio button and then click on the

'Next' button.

9. Choose the ' Don't Search. I will choose the driver to install' radio button. Then click on the 'Next' button.
10. Click the 'Have disk...' button then click the 'Browse...' button. Then choose the appropriate drive F: (CD-ROM Drive).
11. Click the 'Open' button, then click the 'OK' button.
12. Choose your monitor model and click the 'Next' button.  
- If you can see the 'has not passed Windows Logo testing to verify its compatibility with Windows XP' message please click the 'Continue Anyway' button.
13. Click 'Finish' button then the 'Close' button.
14. Click 'OK' button and then the 'OK' button again to close the Display\_Properties dialog box.

If your Windows 95/98/2000/Me/XP version is different or you need more detailed installation information, please refer to Windows 95/98/2000/Me/XP user's manual.



[RETURN TO TOP OF THE PAGE](#)

# Accessories (optional)

Your LCD Monitor : [Front View Product Description](#) • [Connecting to Your PC](#) • [Getting Started](#) • [Optimizing Performance](#)

Accessories (optional): [USB Hub](#) • [Protective Cover](#) • [Ergo Base](#)

## Accessories (optional)

Item	Description	150P2E	150P2M	150B2B	150S2B	150S2P
	<p><b>USB Hub: (PCUH411)</b> USB hub supports four down stream ports and one upstream port</p> <p>Color: Light gray</p>	v	v	v		
	<p><b>Protective Cover: (XG3P30)</b> Anti-scratch, anti-reflective cover, with 3H hardness to protect the LCD screen.</p> <p>Color: Light gray</p>	v	v	v	v	v
	<p><b>Ergo Base: (UG3P30)</b> With tilt, swivel. Height adjustment and portrait display.</p> <p>Color: Light gray</p>		v	v	v	v

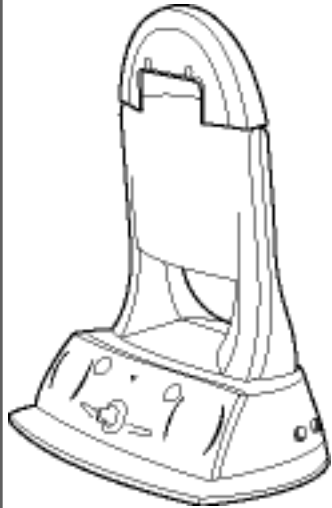
	<p><b>Multimedia Base: (VG3P30)</b> 2W each, 48W PMPO, stereo front firing &amp; portrait display, tilt &amp; swivel.</p> <p>Color: Light gray</p>	v	v	v	v	v
---	--	---	---	---	---	---

[RETURN TO TOP OF THE PAGE](#)

## USB Hub

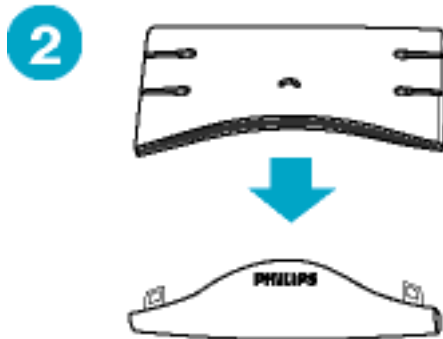
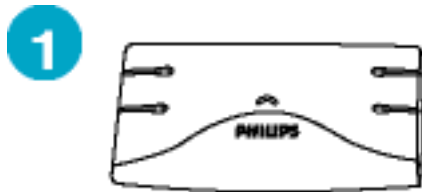

Take off the cover.

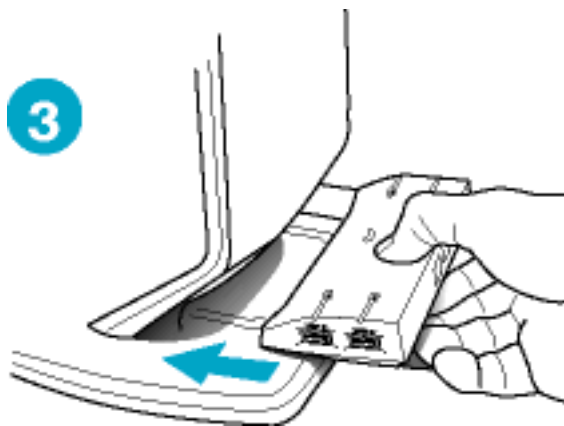

Slide into USB tray on rear side of base.



[RETURN TO TOP OF THE PAGE](#)

## Protective Cover

Protect the LCD screen of your Philips LCD monitor

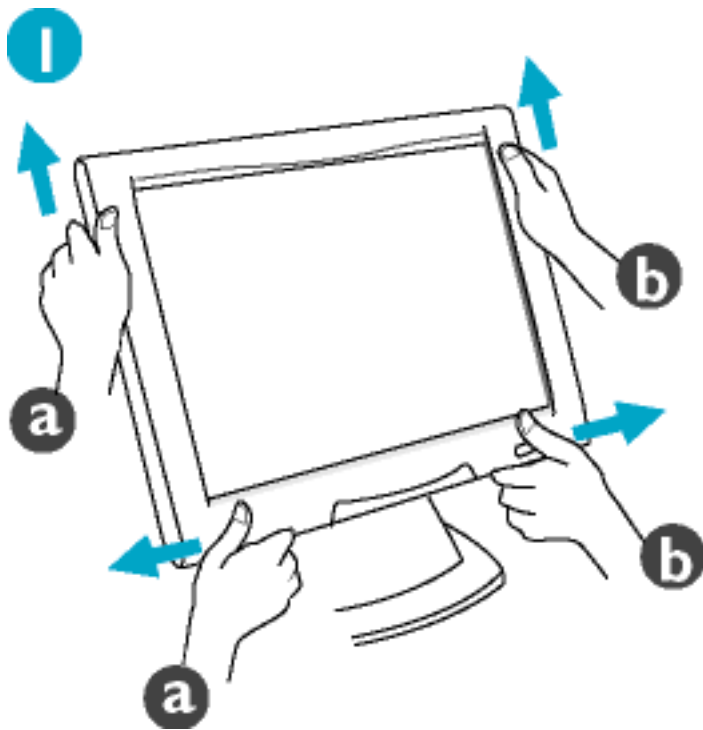

- 1) To remove the bezel,
  - (a) Slide the button located underneath the monitor and slide the bezel up at the same time.
  - (b) Repeat step (a) for the other side.

2

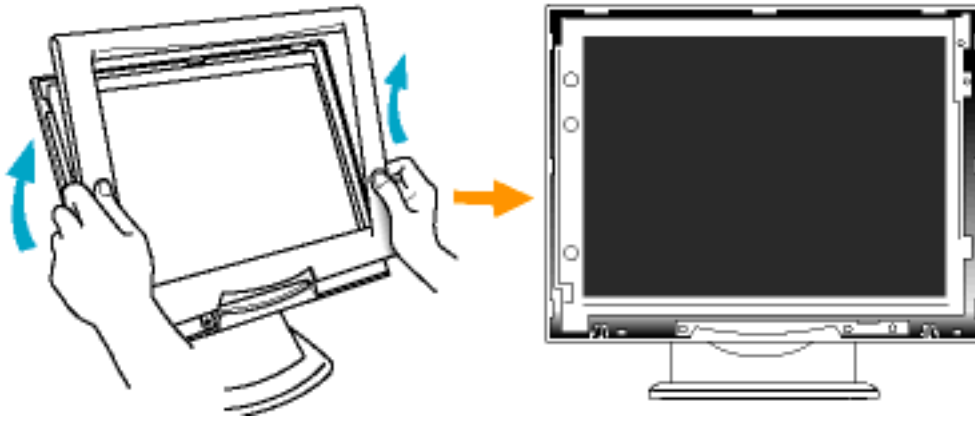

2) Pull forward to remove the front bezel from the monitor.

3

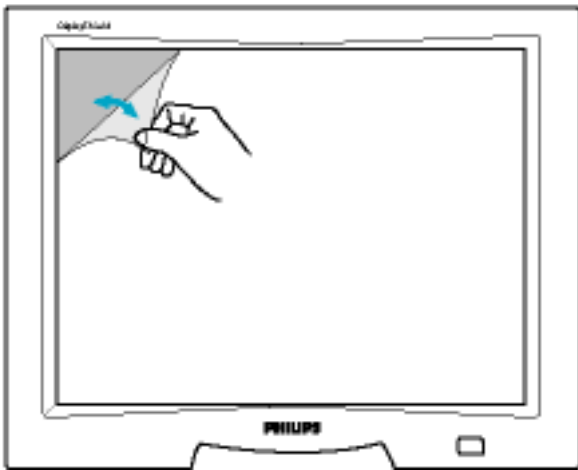

3) Peel off the film from both sides of the protective cover

4) Mount the protective cover by first aligning its clip onto the guide line on above of the control panel (A), then press on (B).

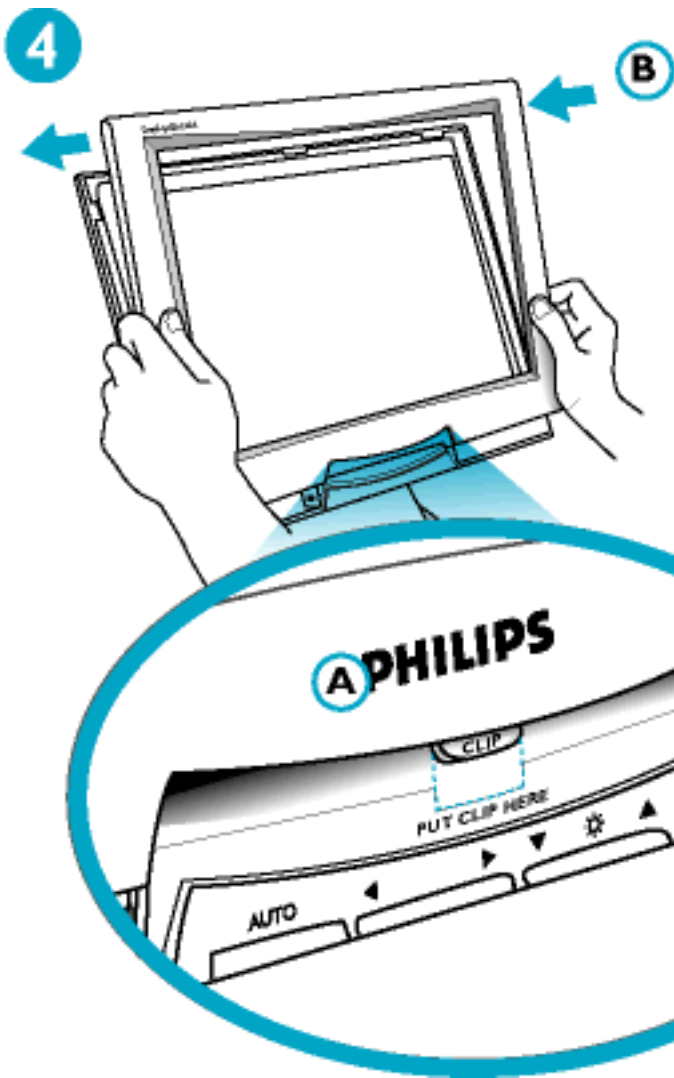

5) Push down the protective cover to mount it securely.

[RETURN TO TOP OF THE PAGE](#)

## Ergo Base

Tilt

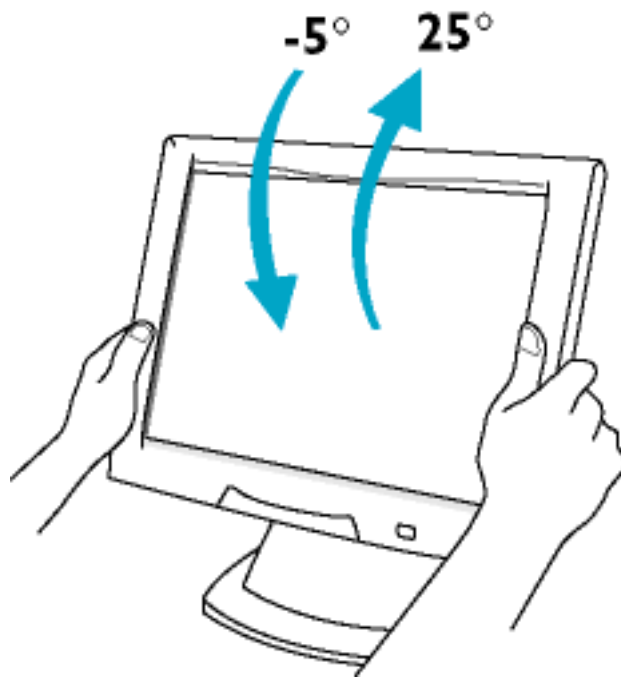

Swivel



Height adjustment

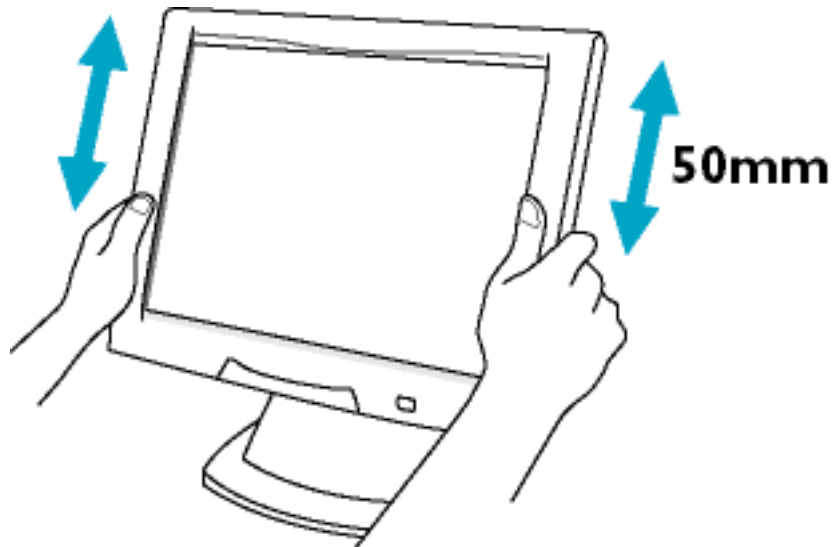



- 1) Tilt the monitor body at an angle

## Portrait display

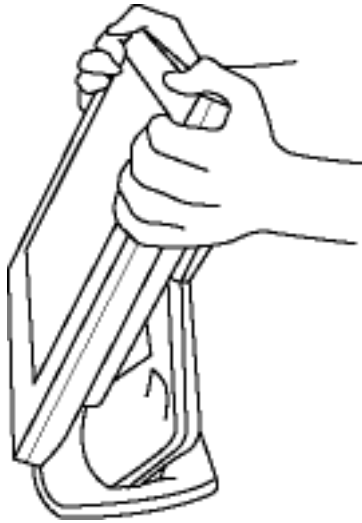

- 2) Rotate the monitor body 90 degrees counter clockwise.

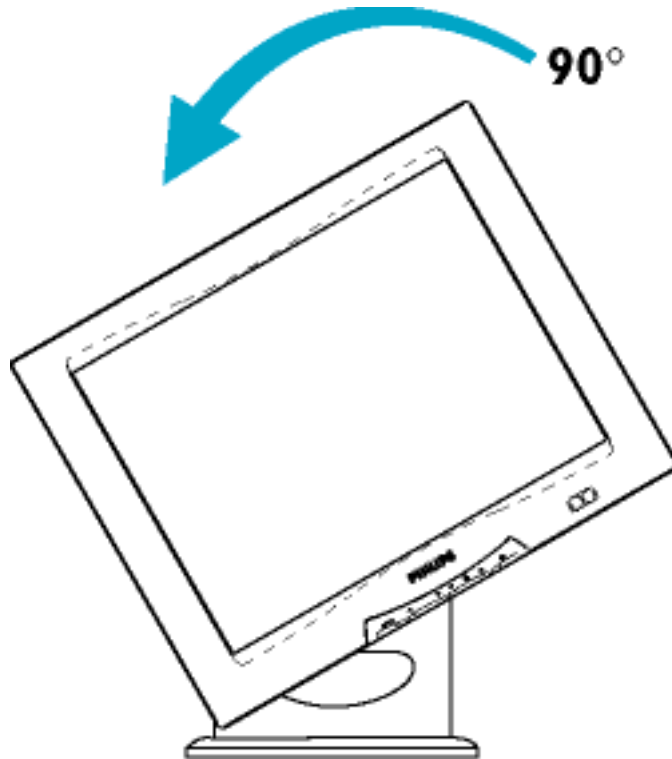

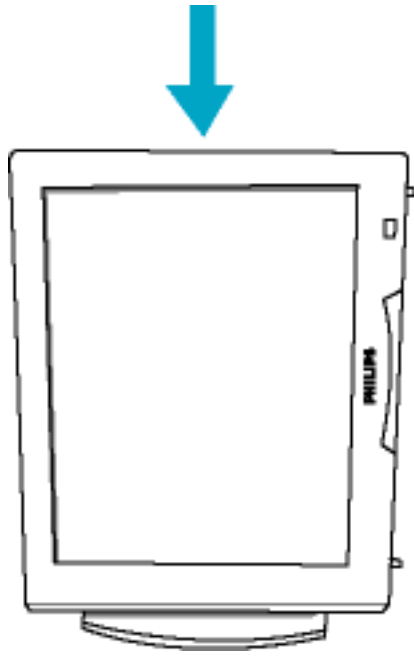

[RETURN TO TOP OF THE PAGE](#)

## Your International Philips F1rst Choice Warranty

Thank you for purchasing this Philips monitor.



All Philips monitors are designed and manufactured to high standards and deliver high-quality performance, ease of use and ease of installation. Should you encounter any difficulties while installing or using this product, please contact Philips directly to benefit from your Philips F1rst Choice Warranty. This three-year service warranty entitles you to a swap model on-site within 48 hours of your call being received.

An extended warranty called Philips F1rst Choice Premium is available in addition to your Philips F1rst Choice warranty. For more details contact your Philips dealer.

Before contacting Philips, please prepare the following details so we can solve your problem quickly.

- Philips type number
- Philips serial number
- Purchase date (copy of purchase may be required)
- PC environment Processor:
  - 286/386/486/Pentium Pro/Internal memory
  - Operating system (Windows, DOS, OS/2, MAC)
  - Fax/Modem/Internet program?
- Other cards installed

Having the following information available will also help speed up the process:

- Your proof of purchase indicating: date of purchase, dealer name, model and product serial number.
- The full address to which the swap model should be delivered.

### Just a phone call away

Philips' customer help desks are located worldwide. You can contact Philips Monday - Friday from 08.00 - 20.00 hrs Central European Time (CET) and on Saturdays and Sundays from 10.00 to 18.00 hrs CET by using one of the toll-free numbers. Click here to access the [F1rst Choice Contact Information](#). Or you can reach us via:

Website: <http://www.philips.com>

# Your International Guarantee

Dear Customer,

Thank you for purchasing this Philips product which has been designed and manufactured to the highest quality standards.

If, unfortunately, something should go wrong with this product Philips guarantees free of charge labor and replacement parts irrespective of the country where it is repaired during a period of 12 months from date of purchase. This international Philips guarantee complements the existing national guarantee obligations to you of dealers and Philips in the country of purchase and does not affect your statutory rights as a customer.

The Philips guarantee applies provided the product is handled properly for its intended use, in accordance with its operating instructions and upon presentation of the original invoice or cash receipt, indicating the date of purchase, dealer's name and model and production number of the product.

The Philips guarantee may not apply if:

- the documents have been altered in any way or made illegible;
- the model or production number on the product has been altered, deleted, removed or made illegible;
- repairs or product modifications and alterations have been executed by unauthorized service organizations or persons;
- damage is caused by accidents including but not limited to lightning, water or fire, misuse or neglect.

Please note that the product is not defective under this guarantee in the case where modifications become necessary in order for the product to comply with local or national technical standards which apply in countries for which the product was not originally designed and/or manufactured. Therefore always check whether a product can be used in a specific country.

In case your Philips product is not working correctly or is defective, please contact your Philips dealer. In the event you require service whilst in another country a dealer address can be given to you by the Philips Consumer Help Desk in that country, the telephone and fax number of which can be found in the relevant part of this booklet.

In order to avoid unnecessary inconvenience, we advise you to read the operating instructions carefully before contacting your dealer. If you have questions which your dealer cannot answer or any related question please contact the [Philips Consumer Information Centers](#) or via:

Website: <http://www.philips.com>

# LIMITED WARRANTY (Computer Monitor)

## Three Years Free Labor / Three Years Free Service on Parts / One Year Exchange\*

*\*Product will be exchanged with a new or renewed to original specifications unit within two business days for the first year. This product must be shipped in at your expense for service during years two and three.*

### WHO IS COVERED?

You must have proof of purchase to receive warranty service. A sales receipt or other document showing that you purchased the product is considered proof of purchase. Attach it to this owner's manual and keep both nearby.

### WHAT IS COVERED?

Warranty coverage begins the day you buy your product. *For three years thereafter*, all parts will be repaired or replaced, and labor is free. *After three years from the day of purchase*, you pay for the replacement or repair of all parts, and for all labor charges.

All parts, including repaired and replaced parts, are covered only for the original warranty period. When the warranty on the original product expires, the warranty on all replaced and repaired products and parts also expires.

### WHAT IS EXCLUDED?

Your warranty does not cover:

- labor charges for installation or setup of the product, adjustment of customer controls on the product, and installation or repair of antenna systems outside of the product.
- product repair and/or part replacement because of misuse, accident, unauthorized repair or other cause not within the control of Philips Consumer Electronics.
- reception problems caused by signal conditions or cable or antenna systems outside the unit.
- a product that requires modification or adaptation to enable it to operate in any country other than the country for which it was designed, manufactured, approved and/or authorized, or repair of products damaged by these modifications.
- incidental or consequential damages resulting from the product. (Some states do not allow the exclusion of incidental or consequential damages, so the above exclusion may not apply to you. This includes, but is not limited to, prerecorded material, whether copyrighted or not copyrighted.)
- a product used for commercial or institutional purposes.

### Where IS SERVICE AVAILABLE?

Warranty service is available in all countries where the product is officially distributed by Philips Consumer Electronics. In countries where Philips Consumer Electronics does not distribute the product, the local

Philips service organization will attempt to provide service (although there may be a delay if the appropriate spare parts and technical manual(s) are not readily available).

## Where CAN I GET MORE INFORMATION?

For more information, contact the Philips Customer Care Center by calling [\(877\) 835-1838 \(U.S.A. customers only\)](tel:8778351838) or [\(903\) 242-4804](tel:9032424804).

### *Before Requesting Service...*

Please check your owner's manual before requesting service. Adjustments of the controls discussed there may save you a service call.

## TO GET WARRANTY SERVICE IN U.S.A., PUERTO RICO OR U.S. VIRGIN ISLANDS...

Contact the Philips Customer Care Center phone number listed below for product assistance and procedures for servicing:

*Philips Customer Care Center*

*(877) 835-1838 or (903) 242-4804*

*(In U.S.A., Puerto Rico and U.S. Virgin Islands, all implied warranties, including implied warranties of merchantability and fitness for a particular purpose, are limited in duration to the duration of this express warranty. But, because some states do not allow limitations on how long an implied warranty may last, this limitation may not apply to you.)*

## TO GET WARRANTY SERVICE IN CANADA...

Please contact Philips at:

*(800) 479-6696*

Three years free parts and three years free labor will be provided at Philips Canada depot or any one of its authorized service centers.

*(In Canada, this warranty is given in lieu of all other warranties. No other warranties are expressed or implied, including any implied warranties of merchantability or fitness for a particular purpose. Philips is not liable under any circumstances for any direct, indirect, special, incidental or consequential damages, howsoever incurred, even if notified of the possibility of such damages.)*

**REMEMBER...** Please record the model and serial numbers found on the product below.

MODEL # \_\_\_\_\_

SERIAL # \_\_\_\_\_

*This warranty gives you specific legal rights. You may have other rights which vary from state/province to state/province.*

Philips Customer Care Center, P. O. Box 2976, Longview, TX 75601

---

## Your International Philips F1rst Choice Warranty

Thank you for purchasing this Philips monitor.



All Philips monitors are designed and manufactured to high standards and deliver high-quality performance, ease of use and ease of installation. Should you encounter any difficulties while installing or using this product, please contact Philips directly to benefit from your Philips F1rst Choice Warranty. This three-year service warranty entitles you to a swap model on-site within 48 hours of your call being received within the first year of purchase. If you have any problems with your monitor within the second or third year of purchase, we will repair it after it has been sent to the service provider at your expense and returned to you within five working days, free of charge.

An extended warranty called Philips F1rst Choice Premium is available in addition to your Philips F1rst Choice warranty. For more details contact your Philips dealer.

Before contacting Philips, please prepare the following details so we can solve your problem quickly.

- Philips type number
- Philips serial number
- Purchase date (copy of purchase may be required)
- PC environment Processor:
  - 286/386/486/Pentium Pro/Internal memory
  - Operating system (Windows, DOS, OS/2, MAC)
  - Fax/Modem/Internet program?
- Other cards installed

Having the following information available will also help speed up the process:

- Your proof of purchase indicating: date of purchase, dealer name, model and product serial number.
- The full address to which the swap model should be delivered.

### Just a phone call away

Philips' customer help desks are located worldwide. You can contact Philips Monday - Friday from 08.00 - 20.00 hrs Central European Time (CET) and on Saturdays and Sundays from 10.00 to 18.00 hrs CET by using one of the toll-free numbers. Click here to access the [F1rst Choice Contact Information](#). Or you can reach us via:

Website: <http://www.philips.com>

# F1rst Choice Contact Information

## Telephone numbers:

Austria	01 546 575 603	Luxembourg	408 443 5501
Belgium	02 275 0701	Netherlands	053 482 9800
Cyprus (Greek)	800 92256	Norway	22 70 82 50
Denmark	35 25 87 61	Portugal	0800 831 363
France	03 8717 0033	Sweden	08 632 0016
Germany	0696 698 4712	Switzerland	02 23 10 21 16
Greece	00800 3122 1223	Spain	09 17 45 62 46
Finland	09 2290 1908	United Kingdom	0207 949 0069
Ireland	01 601 1161	U.S.A.	877 835 1838
Italy	02 48 27 11 53		



# Consumer Information Centers

[Antilles](#) • [Argentina](#) • [Australia](#) • [Bangladesh](#) • [Brasil](#) • [Canada](#) • [Chile](#) • [China](#) • [Colombia](#) • [Czech Republic](#) • [Dubai](#) • [Egypt](#) • [Hong Kong](#) • [Hungary](#) • [India](#) • [Indonesia](#) • [Japan](#) • [Korea](#) • [Malaysia](#) • [Mexico](#) • [Morocco](#) • [New Zealand](#) • [Pakistan](#) • [Paraguay](#) • [Peru](#) • [Philippines](#) • [Poland](#) • [Russia](#) • [Singapore](#) • [South Africa](#) • [Taiwan](#) • [Thailand](#) • [Turkey](#) • [Uruguay](#) • [Venezuela](#)

## Eastern Europe

### CZECH REPUBLIC

Philips Service  
V Mezihorí 2180 00 Prague  
Phone: (02)-6831581  
Fax : (02)-66310852

### HUNGARY

Philips Markaszerviz.  
Kinizsi U 30-36Budapest 1092  
Phone: (01)-2164428  
Fax : (01)-2187885

### POLAND

Philips Polska CE  
UL.Marszalkowska 45/49  
00-648 Warszawa  
Phone: (02)-6286070  
Fax : (02)-6288228

### RUSSIA

Philips Representation Office  
Ul. Usacheva 35a  
119048 Moscow  
Phone: 095-755 6900  
Fax : 095-755 6923

### TURKEY

Türk Philips Ticaret A.S.  
Talatpasa Caddesi No 5.  
80640-Gültepe/Istanbul  
Phone: (0800)-211 40 36  
Fax : (0212)-281 1809

## Latin America

## ANTILLES

Philips Antillana N.V.  
Kaminda A.J.E. Kusters 4  
Zeelandia, P.O. box 3523-3051  
Willemstad, Curacao  
Phone: (09)-4612799  
Fax : (09)-4612772

## ARGENTINA

Philips Antillana N.V.  
Kaminda A.J.E. Kusters 4  
Zeelandia, P.O. box 3523-3051  
Willemstad, Curacao  
Phone: (09)-4612799  
Fax : (09)-4612772

## BRASIL

Philips da Amazônia Ind. Elet. Ltda.  
Centro de Informações ao Consumidor  
R. Alexandre Dumas, 2100-5. andar  
Phone: 0800-123-123  
Fax : (0xx11) 3141-1580

## CHILE

Philips Chilena S.A.  
Avenida Santa Maria 0760  
P.O. box 2687 Santiago de Chile  
Phone: (02)-730 2000  
Fax : (02)-777 6730

## COLOMBIA

Industrias Philips de Colombia  
S.A.-Division de Servicio  
CARRERA 15 Nr. 104-33  
Bogota, Colombia  
Phone: (01)-9800-9-18971 (toll free)  
Fax : (01)-619-5377

## MEXICO

Consumer Information Centre  
Norte 45 No.669  
Col. Industrial Vallejo  
C.P.02300, -Mexico, D.F.  
Phone: (05)-3687788 / 9180050462  
Fax : (05)-7284272

## PARAGUAY

Philips del Paraguay S.A.  
Avenida Artigas 1519  
Casilla de Correos 605  
Asuncion  
Phone: (021)-211666  
Fax : (021)-213007

## PERU

Philips Peruana S.A.  
Customer Desk  
Comandante Espinar 719  
Casilla 1841  
Limab18  
Phone: (01)-2412890  
Fax : (01)-2412913

## URUGUAY

Ind.Philips del Uruguay S.A.  
Avenida Uruguay 1287  
Customer Help Desk  
11100 Montevideo  
Phone: (02)-923392  
Fax : (02)-920752

## VENEZUELA

Industrias Venezolanas Philips S.A.  
Apartado Postal 1167  
Caracas 1010-A  
Phone: (02) 2377575  
Fax : (02) 2376420

## Canada

### CANADA

Philips Electronics Ltd.  
281 Hillmount Road  
Markham, Ontario L6C 2S3  
Phone: (800) 479-6696

## Pacific

### AUSTRALIA

Philips Consumer Service.  
Customer Information Centre.  
3 Figtree Drive  
Homebush Bay NSW 2140  
Phone: (02)-131391  
Fax : (02)-97644681

## NEW ZEALAND

Philips New Zealand Ltd.  
Consumer Help Desk  
2 Wagener Place, Mt. Albert  
P.O. box 1041  
Auckland  
Phone: 0800 658 224 (toll free)  
Fax : (09)-8497858

## Asia

### BANGLADESH

Philips Service Centre  
100 Kazi Nazrul Islam  
Avenue Kawran Bazar C/A  
Dhaka-1215  
Phone: (02)-812909  
Fax : (02)-813062

### CHINA

BEIJING  
Beijing Authorized Service Centre.  
Consumer Information Centre  
Building 6, West Street  
Chong Wen Men, Beijing, Jin Bang Co. Led.  
100051 BEIJING  
Phone: (010)-65122276  
Fax : (010)-65226236

GUANGZHOU  
Philips Authorized Service Centre  
801 Dong Feng Road East  
Guangzhou 510080  
Phone: (020)-7766990  
Fax : (020)-7766990

SHANGHAI  
Philips Service Logistic Centre  
Consumer Information Centre  
P.O.Box 002-027, Nextage Department Store  
Puding New District  
200002 SHANGHAI  
Phone: (021)-63511263  
Fax : (021)-63510799

Philips Authorized Service Centre  
Consumer Information Centre  
148 Fu Jian Road M  
200001 Shanghai  
Phone: (02)-812909

Consumer Information Centers

Fax : (02)-813062

**HONG KONG**

Philips Hong Kong Limited  
Consumer Information Centre  
16/F Hopewell Centre  
17 Kennedy Road, WANCHAI  
Phone: 2821-5345  
Fax : 2861-3104

**INDIA**

**BOMBAY**  
Philips India  
Customer Relation Centre  
Bandbox House  
254-D Dr. A Besant Road, Worli  
Bombay 400 025  
Phone: (022)-4926611  
Fax : (022)-4941698

**CALCUTTA**  
Customer Relation Centre  
7 justice Chandra Madhab Road  
Calcutta 700 020  
Phone: (033)-747333  
Fax : (033)-4753839

**MADRAS**  
Customer Relation Centre  
3, Haddows Road  
Madras 600 006  
Phone: (044)-8292221  
Fax : (044)-8275208

**NEW DELHI**  
Customer Relation Centre  
68, Shivaji Marg  
New Dehli 110 015  
Phone: (011)-5469692  
Fax : (011)-5442402

**INDONESIA**

Philips Group of Companies in Indonesia  
Consumer Information Centre  
Jl.Buncit Raya Kav. 99-100  
12510 Jakarta  
Phone: (021)-7940040  
Fax : (021)-7940080

## JAPAN

Philips Consumer Electronics  
1-11-9,Ebisuminami  
Shibuya-Ku  
Tokyo 150  
Phone: (03)-3719-2235  
Fax : (03)-3715-9992

## KOREA

Philips Korea Ltd.  
Philips House  
C.P.O. box 3680  
260-199, Itaewon-Dong.  
Yongsan-Ku, Seoul 140-202  
Phone: (02)-5961195/1196 / (02)-5967632/76325  
Fax : (02)-5959688

## MALAYSIA

Philips Malaysia Sdn. Berhad  
Service Dept.  
No.51,sect.13 Jalan University.  
46200 Petaling Jaya, Selagor.  
P.O.box 12163  
50768 Kuala Lumpur.  
Phone: (03)-7562144  
Fax : (03)-7560761

## PAKISTAN

KARACHI  
Philips Electrical Ind. of Pakistan  
Consumer Information Centre  
F-54, S.I.T.E, P.O.Box 7101  
75730 KARACHI  
Phone: (021)-2560071-82  
Fax : (021)-2562386

Philips Consumer Service Centre  
168-F, Adamjee Road  
Rawalpindi Cantt  
Phone: (051)-580902-3  
Fax : (051)-584944

## PHILIPPINES

Philips Electronics and Lighting Inc.  
106 Valero St., Salcedo Village  
Makati, Metro Manilla.  
Phone: (02)-8100161  
Fax : (02)-8173474

## SINGAPORE

Philips Singapore Private Ltd.  
Consumer Service Dept.  
Lorong 1, Toa Payoh., P.O. box 340  
Singapore 1231  
Phone: 3502000  
Fax : 2508037

## TAIWAN

Philips Taiwan Ltd.  
Consumer Information Centre  
Nr 96 Section 1, Chien-Kuo N.Road  
TAIPEI  
Phone: (02)-2382-4567  
Fax : (02)-2134-2670

## THAILAND

Philips Electronics (Thailand) Ltd.  
Philips Service Centre  
209/2 Sanpavut Road,  
Bangna, Bangkok 10260  
Phone : (02)-3980141/3980790  
Fax : (02)-3983319

## Africa

### MOROCCO

Philips Electronique Maroc  
304, BD Mohamed V  
Casablanca  
Phone: (02)-302992  
Fax : (02)-303446

### SOUTH AFRICA

South African Philips.  
S.V. Div. 195 Main R.D.  
Martindale., Johannesburg  
P.O.box 58088  
Newville 2114  
Phone: (011)-4715000  
Fax : (011)-4715034

## Middle East

## DUBAI

Philips Middle East B.V.  
Consumer Information Centre  
P.O.Box 7785  
DUBAI  
Phone: (04)-353666  
Fax : (04)-353999

## EGYPT

Philips Egypt  
Consumer Information Centre  
10, Abdel Rahman El Rafei  
Mohandessin - Cairo, P.O.Box 242  
DOKKI  
Phone: (02)-3313993  
Fax : (02)-3492142