

- [Safety and trouble shooting](#)
- [About this manual](#)
- [Product information](#)
- [Installing your monitor](#)
- [On-screen display](#)
- [Customer care and warranty](#)
- [FAQ](#)
- [Glossary](#)
- [Download & print](#)
  
- [EXIT](#)



# 107T

## Electronic User's Manual

# Safety and Troubleshooting Information

[Safety Precautions and Maintenance](#) • [Troubleshooting](#) • [Regulatory Information](#) • [Other Related Information](#)

---

## Safety precautions and maintenance



**WARNING: Use of controls, adjustments, or procedures other than those specified in this documentation may result in exposure to shock, electrical hazards, and/or mechanical hazards.**

Read and follow these instructions when connecting and using your computer monitor:

- Disconnect the monitor from the power supply if the monitor is not to be used for an extended period of time.
- Do not attempt to remove the back cover, as you will be exposed to a shock hazard. The back cover should only be removed by qualified service personnel.
- Do not place objects on top of the monitor cabinet, objects could fall into vents or cover them and prevent proper cooling of the monitor's electronic devices.
- To avoid the risk of shock or permanent damage to the set, do not expose the monitor to rain or excessive moisture.
- Do not use alcohol or ammonia-based liquid to clean the monitor. If necessary, clean with a slightly damp cloth. Disconnect the monitor from the power supply before cleaning.
- When positioning the monitor, make sure the power plug and outlet are easily accessible.

Consult a service technician if the monitor does not operate normally when operating instructions of this manual are followed.

[RETURN TO TOP OF THE PAGE](#)

# About This Electronic User's Manual

[About This Guide](#) • [Other Documents You May Need](#) • [Notational Descriptions](#)

---

## About This Guide

This electronic user's guide is intended for anyone who uses the Philips Color Monitor. It describes the monitor's features, setup, operation and all other information, which is the same exact information described in our printed version.

The sections are as follows:

- [Safety and Troubleshooting Information](#) provides tips and solutions for common problems, and other related information you may need.
- About This Electronic User's Manual gives overview of what information are included as well as notation icon descriptions and other documentation you can refer to.
- [Product Information](#) gives an overview of the monitor's features and as well as the technical specifications for this monitor.
- [Installing Your Monitor](#) describes the initial setup process and gives an overview of how to use the monitor.
- [On Screen Display](#) provides information on adjusting the settings on your monitor.
- [Customer Care and Warranty](#) is a list of worldwide Philips consumer information centers along with the help desk phone numbers and information on the applicable warranty of your product..
- [Glossary](#) provides more information for technical terms.
- [Download](#) allows users to install the entire manual on their hard drive.
- [Frequently Asked Questions](#) provides answers to commonly asked questions.

[RETURN TO TOP OF THE PAGE](#)

---

## Other Documents You May Need

In addition to this *Electronic User's Guide*, you may need to refer to the following documentation:

- *Philips Color Monitor Quick Start Guide* which summarizes the steps for setting up the monitor. This is included with this product.

[RETURN TO TOP OF THE PAGE](#)

---

## Notational Descriptions

The following subsections describe notational conventions used in this document.

## Notes, Cautions, and Warnings

Throughout this guide, blocks of text may be accompanied by an icon and printed in bold type or in italic type. These blocks are notes, cautions, and warnings, and they are used as follows:



**NOTE:** This icon indicates important information and tips that help you make better use of your computer system.



**CAUTION:** This icon indicates information that tells you how to avoid either potential damage to hardware or loss of data.



**WARNING:** This icon indicates the potential for bodily harm and tells you how to avoid the problem.



**SMART HELP:** This icon indicates helpful information when adjusting the On Screen Display of your monitor.

Some warnings may appear in alternate formats and may be unaccompanied by an icon. In such cases, the specific presentation of the warning is mandated by regulatory authority.

[RETURN TO TOP OF THE PAGE](#)

---

©2001 Koninklijke Philips Electronics N.V.

All rights reserved. Reproduction, copying, usage, modifying, hiring, renting, public performance, transmission and/or broadcasting in whole or in part is prohibited without written consent of Philips Electronics N.V.

---

# Product Information

[Product Features](#) • [LightFrame™ for Windows](#) • [Technical Specifications](#) • [Automatic Power Saving](#) • [Physical Specification](#) • [Pin Assignment](#) • [Product Views](#)

---

## Product Features

### 107T20

- 17-inch (16.0" VIS) color monitor with excellent front of screen performance for use with MACs and PCs
- Autoscan covers horizontal frequencies up to 71 kHz offering a maximum resolution of 1280 x 1024 with flicker free display of 1024 x 768 at up to 89 Hz.
- Real Flat High Contrast CRT with high-resolution 0.25 mm dot pitch (0.21 hdp)
- LightFrame™ for brightest and sharpest display of movie and photo windows.
- Large screen display in a small footprint: World's shortest 17-inch conventional monitor with maximum depth of only 419 mm/16.5"
- Multimedia Base and USB Hub option.
- FCC, CE (in selected countries only) and ISO9241, ISO14001 certified

### 107T21

- 17-inch (16.0" VIS) color monitor with excellent front of screen performance for use with MACs and PCs
- Autoscan covers horizontal frequencies up to 71 kHz offering a maximum resolution of 1280 x 1024 with flicker free display of 1024 x 768 at up to 89 Hz.
- Real Flat High Contrast CRT with high-resolution 0.25 mm dot pitch (0.21 hdp)
- LightFrame™ for brightest and sharpest display of movie and photo windows.
- Large screen display in a small footprint: World's shortest 17-inch conventional monitor with maximum depth of only 419 mm/16.5"
- Multimedia Base and USB Hub option.
- FCC, CE (in selected countries only) and ISO9241, ISO14001 certified

[RETURN TO TOP OF THE PAGE](#)

---

## LightFrame™ for Windows

### Introduction

Philips LightFrame™ feature enriches the experience of pictures and video on a Philips CRT (picture tube) monitor. LightFrame™ will boost the brightness and sharpness of photos and videos on the monitor screen.

To control the LightFrame™ feature in your monitor, you have to install the LightFrame™ application which you will find on this CD-ROM.

### **Note**

Philips LightFrame™ will only work with monitors that have been built to use this software. Earlier Philips monitors or other manufacturers' monitors will not work with this special software. It is recommended that you install this software only on a Philips monitor designed to use it. These monitors can be identified by the LightFrame™ logo on the front of the monitor.

This software is not designed for use with LCD flat screen monitors.

LightFrame™ will work with true Windows-based programs and DOS-based programs that operate in a Windows environment. It will not work with DOS-based programs operating only in a DOS environment.

### **Language Selection**

While English is the default language of LightFrame™, the User Interface can be set up to operate in Dutch, French, German, Italian, Portuguese, Spanish, Simplified Chinese, Traditional Chinese or Korean.

### **Installation**

- 1) To install LightFrame™, place the CD in the CD-ROM drive.
- 2) Next, when the menu of items on the CD appears on your screen, click on 'Install LightFrame™'.
- 3) Now, follow the on-screen prompts to properly install the program. The software checks to see if you have a compatible monitor. You must agree to the license agreement terms for the software to install.
- 4) After installation, LightFrame™ automatically loads and the icon appears in the taskbar.

### **Notes**

If LightFrame™ detects that your monitor is not LightFrame™ compatible, a message appears on the monitor screen. If you see this message, you can select to abort or continue the installation. However, if you continue the installation, LightFrame™ will probably not work on the monitor.

### **How to use LightFrame™**

After installation, LightFrame™ starts up automatically whenever the computer is started.

For information about using LightFrame™ please refer to the help information which is available after installation.

### **Compatibility**

This version of LightFrame™ is compatible with Windows 95

Windows 98  
Windows Me (Millenium Edition)  
Windows XP  
Windows 2000 Professional Edition.

## LightFrame™ 2 -- Frequently Asked Questions (and answers)

### LightFrame™

#### Q. What is LightFrame™?

A. LightFrame™ is an exclusive Philips hardware/software technology for the brightest, highest contrast-ever on-demand display of photos and video on a monitor. It enhances the display quality of photos and videos in a selected window **without** impacting upon display of text-based applications.

#### Q. What is LightFrame™ 2?

A. LightFrame2 is a second-generation software package that working in conjunction with factory installed LightFrame™ hardware adds great new features to LightFrame™.

#### Q: How can I tell if my monitor comes with LightFrame™ 2?

A: All Philips LightFrame™ 2 monitors display this logo on their front bezel:



#### Q: How does LightFrame™ work?

A: LightFrame™ consists of a software application and an Integrated Circuit (IC) embedded in the monitor.

Together, they boost brightness and sharpness in a user defined window or screen area. Unique LightFrame™ technology dramatically improves photo and video display quality.

#### Q: Is the size of the LightFrame™ screen limited?

A: No. You can select a single window or, using the drag mode, select the entire display area. The only limitation is the visible screen area of your monitor. The minimum size of a LightFrame™ dragged area is 20 by 20 pixels.

#### Q: Will LightFrame™ shorten the life of a monitor? Is phosphor burn-in a potential problem?

**A:** No. Extensive testing has confirmed that LightFrame™ does not adversely effect monitor life. Today's state-of-the-art Philips monitors employ improved phosphors and are designed for high light output. LightFrame™ normally highlights photos and video. Though the peak brightness of the highlighted area is strongly increased, the average brightness—a determining factor for cathode deterioration—is not normally increased. In any case, a special Automatic Beam Limiter (ABL) circuit keeps a monitor's maximum average brightness within acceptable levels.

## **Upgrading to LightFrame™ 2**

### **Q: How do I upgrade from LightFrame™ to LightFrame™ 2?**

**A:** It's easy: Download LightFrame™ 2 software for any monitor equipped with LightFrame from the Philips web site ([www.pcstuff.philips.com](http://www.pcstuff.philips.com)). Remember the directory into which you saved the upgrade. When you click on the downloaded program icon, LightFrame™ 2 scans your system, removes old versions and upgrades automatically to LightFrame™ 2. But remember: Your monitor must have the LightFrame™ feature to upgrade to LightFrame™ 2.

### **Q: Can I install LightFrame™ 2 over an older version? Must previous versions be uninstalled?**

**A:** The LightFrame™ 2 installation program scans your system, removes old versions and upgrades automatically to LightFrame™ 2. Here's how: If you downloaded the upgrade from the Philips Web site, remember the directory into which you saved the upgrade. When you click on the Setup icon, LightFrame™ 2 scans your system, removes old versions and upgrades automatically to LightFrame™ 2. To upgrade from a CD-ROM disk, click on the Setup icon located in the \PC\LightFrame™ folder, select *Install LightFrame™ 2* and follow on screen prompts.

### **Q: What will happen when my system is no longer connected to a LightFrame™-enabled monitor for example, when I take my notebook on the road?**

**A:** Philips exclusive LightFrame™ feature requires the combined operation of hardware that resides in your monitor and software installed on your system. It only works when a monitor with built-in hardware receives commands from system software. Without both the LightFrame™ hardware-equipped monitor and system software, LightFrame™ does not function.

### **Q: What's new in LightFrame™ 2?**

**A:** LightFrame™ 2 is full of neat new features: Here are just a few:

- Automatic detection of photos and videos on Web pages.
- Full screen highlighting through a Windows keyboard shortcut.
- Improved compatibility with multimedia applications.

To experience these and other new features, start using LightFrame™ 2 today!

## **LightFrame™2 applications and operating systems**

### **Q: Can I use LightFrame™2 in DOS mode?**

**A:** Yes, but in DOS, LightFrame™ 2 highlights the entire screen and must be manually switched on from the OSD menu. **Here's how:** Open your monitor's OSD controls. Go to LIGHTFRAME in the EXTRA CONTROLS menu. Press the left/right button to switch LightFrame™ on or off.

### **Q: Can I use LightFrame™ 2 with my favorite game?**

**A:** Absolutely. LightFrame™ can be used with any Windows game. When a DOS game runs in a DOS



window, LightFrame™ must be manually switched on from the OSD menu. **Here s how:** Open your monitor s OSD controls. Go to LIGHTFRAME in the EXTRA CONTROLS menu. Press the left/right button to switch LightFrame™ on or off.

**Q: Does LightFrame™ 2 work on Mac computers?**

**A:** Yes. Using drives that come with your monitor, LightFrame™ operates under MacOS8 or MacOS9. Due to hardware limitations, LightFrame™ is activated manually on Mac computers and functions are limited.

**Q: Can I use LightFrame™ on a computer running Unix, Linux or other operating system?**

**A:** Presently no application software exists for Unix or Linux. Unix is predominately used for high-end professional applications. Because their users seldom view photos or video, our high-end large screen products do not support LightFrame™.

**Q: Does LightFrame™ consume excessive system resources?**

**A:** Because the monitor handles LightFrame™ processing, the feature consumes no system resources when a portion of the screen is highlighted. Installed on a PC, the small LightFrame™ application program is active in the Windows system tray, but remains idle until a window is selected for highlighting. As soon as the monitor receives the initiate command from this software, the application again becomes idle, consuming few if any system resources. On rare occasions when a memory-hungry application pushes system resources to their limit, LightFrame™ can be easily exited to free up additional resources.

**Q: Can I highlight two or more areas in the screen at the same time?**

**A:** No. Monitor hardware processes only a single rectangular area.

**Q: I get a message warning that my monitor 'may not support LightFrame™. I am certain my monitor does. What is wrong?**

**A:** Only a Philips driver can determine if your monitor is equipped with LightFrame™; a generic Windows driver cannot. Install the special Philips driver that came with your monitor. If the warning continues to appear after your Philips driver is installed, ignore the message. LightFrame™ will function properly. You can avoid seeing the message by checking Don t show this message again .

**Q: Is LightFrame™ software or hardware-based?**

**A:** LightFrame™ consists of two important components: a chip in the monitor and software to control this chip. Therefore, LightFrame™ is a seamless interactive combination of both software and hardware.

**LightFrame™ 2 and the Internet**

**Q: Can I use LightFrame™ to browse the Internet?**

**A:** Yes. Integration with Internet Explorer is one of LightFrame™ s neatest new features. Now when you open a Web page, LightFrame™ 2 scans LightFrame™ scans the document for a photo or video and highlights suitable material. Note: When more than one photo is displayed on a Web page, LightFrame™ highlights the largest. If multiple photos are the same size, LightFrame™ highlights top leftmost one. You can select a different photo manually. **Here s how:** Click the LightFrame™ On/Off button. Then hold down the left mouse button and drag a frame around the photo. When you release the mouse button, the selected area is highlighted by LightFrame™.

**Q: Can I use LightFrame™ with Netscape?**

**A:** You can use LightFrame™ with Netscape, but its functions are limited to manually highlighting the entire Netscape client window. Since LightFrame™ is specifically designed for bright, high contrast photo and video

display, highlighting an entire Web page -- including text -- is not recommended.

For best results, we recommend you use LightFrame™ with Microsoft Internet Explorer version 5.0 or higher. You can download Internet Explorer free of charge from the Microsoft website ([www.microsoft.com](http://www.microsoft.com)). A copy of Internet Explorer 5.5 is also included on the CD-ROM shipped with your monitor.

**Q: Will the highlighted area remain highlighted when I open a cached Web page stored locally on my computer?**

**A:** Yes. When a Web page is loaded in Internet Explorer, LightFrame™ scans the document for a photo or video and highlights suitable material. If LightFrame™ finds a photo or video in an online Web page, it will highlight the same object when the page is opened from a local cache.

**Q: On some Web pages, LightFrame™ activates automatically; on others, it doesn't. Why?**

**A:** Computers are smart, but you're smarter! When a Web page loads, LightFrame™ automatically seeks out photos or videos. Although the human eye has no problem picking out photos or videos on a busy Web page, some special backgrounds and borders confuse LightFrame™. Here's why: To comply with the science of cathode ray tube design, LightFrame™ is trained to locate and highlight rectangular screen areas. Sometimes a border or background prevents LightFrame™ from determining where a photo, for example, ends and its border begins. To prevent distorted display when this happens, LightFrame™ will ignore that photo.

The workaround? Highlight the photo manually. Here's how: Click the LightFrame™ On/Off button. Then hold down the left mouse button and drag a frame around the photo. When you release the mouse button, LightFrame™ the selected area is displayed in the LightFrame™ window.

**Q: On some Web pages, LightFrame™ highlights an area that doesn't contain a photo. What should I do?**

**A:** Just as LightFrame™ may occasionally miss a photo, it sometimes is fooled into highlighting a non-photo screen area. In both cases, it's about borders and backgrounds that prevent LightFrame™ from determining what is and what isn't a photo.

The workaround? Click the LightFrame™ Off button to deactivate LightFrame™ in the highlighted area. Then highlight a photo you'd like to display by again clicking the LightFrame™ On/Off button and holding down the left mouse button to drag a frame around the photo. When you release your mouse button, LightFrame™ activates around the selected area.

## Using LightFrame™

**Q: Can I activate LightFrame™ on my entire screen?**

**A:** Yes. **Here's how:** To activate LightFrame™ in its full screen mode from your keyboard, simultaneously press the Windows and letter L keys. (Location of the Windows key varies with keyboards and languages. On most keyboards, it's to the right of the Control key.) To customize the keyboard shortcut for activating LightFrame™ in the full screen mode, go to the LightFrame™ applet in the Windows Control Panel.

An alternative: You can also activate LightFrame™ in its full screen mode from your monitor's OSD. **Here's how:** Open your monitor's OSD controls. Go to LIGHTFRAME in the EXTRA CONTROLS menu. Press the left/right button to switch LightFrame™ on or off.

**Q: Why must I install the application to use LightFrame™?**

**A:** Selectivity is the key to LightFrame™'s effectiveness. Increased brightness and sharpness enhances photos and video display, but deteriorates text and detailed lines. Using LightFrame™ in a full screen mode all the time would degrade display of regular Windows applications. Using LightFrame™ selectively delivers outstanding photo and video display as well as top quality display text for Windows applications. The

software provides interface between the chip in the monitor and the user.

**Q: Can I use LightFrame™ at various resolutions?**

**A:** Yes. LightFrame™ will operate at any resolution supported by the monitor. When changing monitor resolution, a highlighted area is dimmed and the icon switches back to idle. After the new resolution becomes active, LightFrame™ software has to be exited and restarted to load the new resolution .

**Q: Can I use LightFrame" with a non-LightFrame™ equipped monitor?**

**A:** No. Philips exclusive LightFrame™ feature requires the combined operation of hardware that resides in your monitor and software installed on your system. It only works when a monitor with built-in hardware receives commands from system software. Without the LightFrame™ hardware-equipped monitor, LightFrame™ does not function.

**Q: How can I remove the LightFrame™ software from my system?**

**A:** Software can be easily uninstalled with the Windows Add/remove software function in Control Panel or through the Uninstall feature in the Philips LightFrame program group. From the Control Panel Add/remove software screen, select Philips LightFrame™. Then select Add/remove . Alternatively, open the Start menu and select Philips LightFrame from Programs. Select Uninstall and follow the steps of the uninstall feature.

**Q: How can I quickly check to see if my Philips monitor has LightFrame™ or LightFrame™2?**

**A:** Every monitor equipped with LightFrame™ has a logo on the front. The logo looks like this:

If your monitor came with LightFrame™2, than you will find a 2 with the logo. If your monitor doesn't have a LightFrame™2 logo, you can still use the LightFrame™2 software.

**Q: Is LightFrame™ software as well as hardware driven? If it is software driven, what happens when a monitors is switched? How will the system react when a monitor with LightFrame™ is substituted for monitor without LightFrame™?**

**A:** The LightFrame™ feature is a combination of both hardware and software and will not function without both components in place. During installation, the software will check if the monitor is LightFrame™ enabled. Afterwards the computer cannot detect whether the monitor has been exchanged with one without LightFrame™. Without a LightFrame™ monitor, LightFrame™ will not function; however, the system will otherwise operate normally.

**Q: Does LightFrame™ effect moving images or just still images?**

**A:** LightFrame™ can be used on both still pictures and movies.

**A:** The principle behind LightFrame™ makes use of a luminance reserve that is normally present in a CRT monitor. Because the brightness reserve degrades display of text and other native computer documents, it is normally not used. As a rule, LCD monitors do not feature brightness reserve. In LCDs, brightness is normally set at the maximum level.

**Q: What models support LightFrame™?**

**A:** Following models support LightFrame™: 105B2x, 107S2x, 107T2x, 107B2x, 107B3x, 107P2x, 109S2x and 109B2x

**Q: What computer configuration is required to run the feature?**

**A:** LightFrame™'s main component is embedded in the monitor and as such is not dependant on your

system configuration. The LightFrame™ software that controls the hardware in the monitor is available for Windows 95, Windows 98, Windows Millenium Edition (Windows Me), Windows 2000 Professional, Windows XP®, MacOS8 and MacOS9.

All the applications use little to no system resources and therefore don't put higher demands to your system configuration than the operating system does.

**Q: Does the feature effect my colored printout quality?**

**A:** No. LightFrame™ is a feature that only effects the on-screen display. The enhancement is "enclosed" within the monitor and has no influence whatsoever on the quality of printouts.

**Q: How can I change settings for LightFrame™?**

**A:** It's easy: Open the Windows control panel by clicking Settings | Control Panel from your Start panel. In Control Panel, double click on the LightFrame™ icon. You'll see a list of the settings that can be customized. To learn more about customization options, check out the LightFrame™ help file by pressing the help button in the control panel.

**Q: In the OSD menu, what does "LightFrame On/Off" mean?**

**A:** You can switch LightFrame™ on or off from the OSD menu of any LightFrame™ 2 monitor. This is a handy feature when you use DOS applications or other operating systems not supported by the LightFrame™ software.

**Here's how:** Open your monitor's OSD controls. Go to LIGHTFRAME in the EXTRA CONTROLS menu. Press the left/right button to switch LightFrame™ on or off.

**Q: How do I use the LightFrame™ 2 control bar that appears at the top my screen?**

**A:** The control bar is another upgrade that helps you run all LightFrame™ 2's neat, new features. The illustration below describes the tasks each button performs.



Accustomed to working with the original LightFrame™ tray icon? No problem: It's still there and can be used to turn LightFrame™ on or off and check LightFrame™ status.

**Q: Can I move the LightFrame™ 2 control bar?**

**A:** The screen location of the LightFrame™ control bar is fixed. If the control bar blocks your view of an application, you can exit LightFrame™. Here's how: Click once on the LightFrame™ logo and select Exit from the pop-up menu.

When you reboot your system, LightFrame™ will restart automatically. You can also reload LightFrame™ from the Start menu by clicking LightFrame 2 in the Philips LightFrame™ menu under Programs.

**Q: When is LightFrame™ automatically switched off?**

**A:** To avoid less than optimum display even when LightFrame™ is manually activated from the OSD screen, it will automatically switch off when:

- A mode change occurs: for example, when the monitor changes resolution or refresh rate.
- The monitor enters sleep mode.
- The monitor is powered off and on again.

**Q: Can LightFrame™2 highlight simultaneously highlight multiple screen areas?**

**A:** No. LightFrame™ 2 operates in a single rectangular screen area.

[RETURN TO TOP OF THE PAGE](#)

---

## Technical Specifications\*

### CRT

- |                            |   |
|----------------------------|---|
| • Size and deflection      | 17 inch / 41 cm ; 90° deflection angle  |
| • Dot pitch                | 0.25 mm   |
| • Horizontal pitch         | 0.21 mm   |
| • Tube type                | Shadow mask, Real Flat, high contrast, anti-glare, anti-static, anti reflection, light transmission 45% |
| • Phosphor                 | P22   |
| • Recommended display area | 12.0" x 9.0" / 306 x 230 mm   |
| • Maximum display area     | 12.8" x 9.6" / 325 x 244 mm   |

### SCANNING

- |                       |             |
|-----------------------|-------------|
| • Horizontal scanning | 30 - 71 KHz |
| • Vertical scanning   | 50 - 160 Hz |

### VIDEO

- |                       |          |
|-----------------------|----------|
| • Video dot rate      | 108 MHz  |
| • Input impedance     |          |
| - Video               | 75 ohm   |
| - Sync                | 2.2 kOhm |
| • Input signal levels | 0.7 Vpp  |

- Sync input signal                      Separate sync
- Sync polarities                        Composite sync
- Positive and negative

## WHITE COLOR TEMPERATURE

Chromaticity CIE coordinates:

- at 9300 K degrees                       $x = 0.283 / y = 0.297$
- at 6500 K degrees                       $x = 0.313 / y = 0.329$

\* These information are subject to change without notice.

[RETURN TO TOP OF THE PAGE](#)

## Automatic Power Saving

If you have VESA's DPMS compliance display card or software installed in your PC, the monitor can automatically reduce its power consumption when not in use. And if an input from a keyboard, mouse or other input device is detected, the monitor will automatically "wake up". The following table shows the power consumption and signaling of this automatic power saving features:

Power Management Definition						
VESA's Mode	Video	H-sync	V-sync	Power Used	Power Saving (%)	LED color
ON	Active	Yes	Yes	< 73W	0 %	Green
Stand-by	Blanked	No	Yes	< 3W	96%	Yellow
Suspend	Blanked	Yes	No	< 3W	96%	Yellow
OFF	Blanked	No	No	< 3W	96%	Yellow

This monitor is ENERGY STAR<sup>®</sup> compliant. As an ENERGY STAR<sup>®</sup> Partner, PHILIPS has determined that this product meets the ENERGY STAR<sup>®</sup> guidelines for energy efficiency.

[RETURN TO TOP OF THE PAGE](#)

## Physical Specifications

- Dimensions 15.7" x 16.1" x 16.1" / 399 x 410 x 408 mm (including base)  
15.7" x 14.7" x 16.1" / 399 x 373 x 408 mm (excluding base)
- Weight 15.0 kg
- Power supply 90 - 264 VAC, 50/60Hz
- Temperature (operating) 0° to 40°C / 32° to 104°F
- Temperature (storage) -25° to +65°C / -13° to +149°F
- Relative humidity 5% to 95%

\* Resolution 1280 x 1024, standard size, contrast max., brightness 50%, 9300°, full white pattern.

\* These information are subject to change without notice.

[RETURN TO TOP OF THE PAGE](#)

## Pin Assignment

The 15-pin D-sub connector (male) of the signal cable (IBM systems):

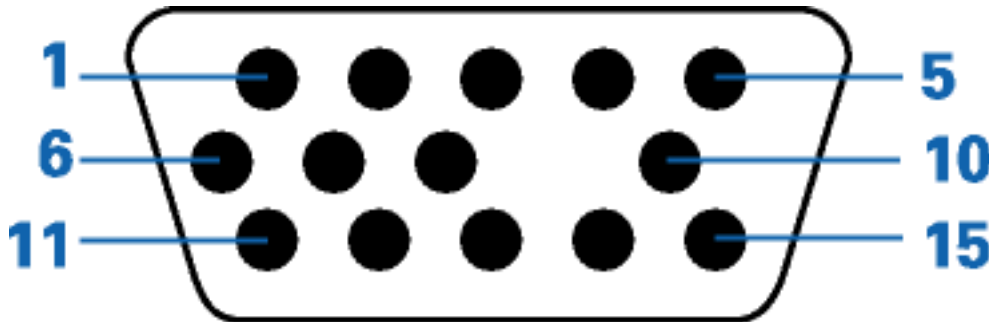

Pin No.	Assignment	Pin No.	Assignment
1	Red video input	9	No pin
2	Green video input	10	Logic ground
3	Blue video input	11	Identical output - connected to pin 10
4	Identical output - connected to pin 10	12	Serial data line (SDA)
5	Ground	13	H. Sync / H+V
6	Red video ground	14	V. Sync (VCLK for DDC)
7	Green video ground	15	Data clock line (SCL)

8

Blue video ground



[RETURN TO TOP OF THE PAGE](#)

---

## Views

Follow the links to see various views of the monitor and its components.

[Front View](#)

[Rear View](#)

[RETURN TO TOP OF THE PAGE](#)



# Installing your Monitor

[Front View](#) • [Rear View](#) • [6G3B11 Multimedia Base \(option\)](#) • [PCUH411 USB Hub \(option\)](#)

## Front View

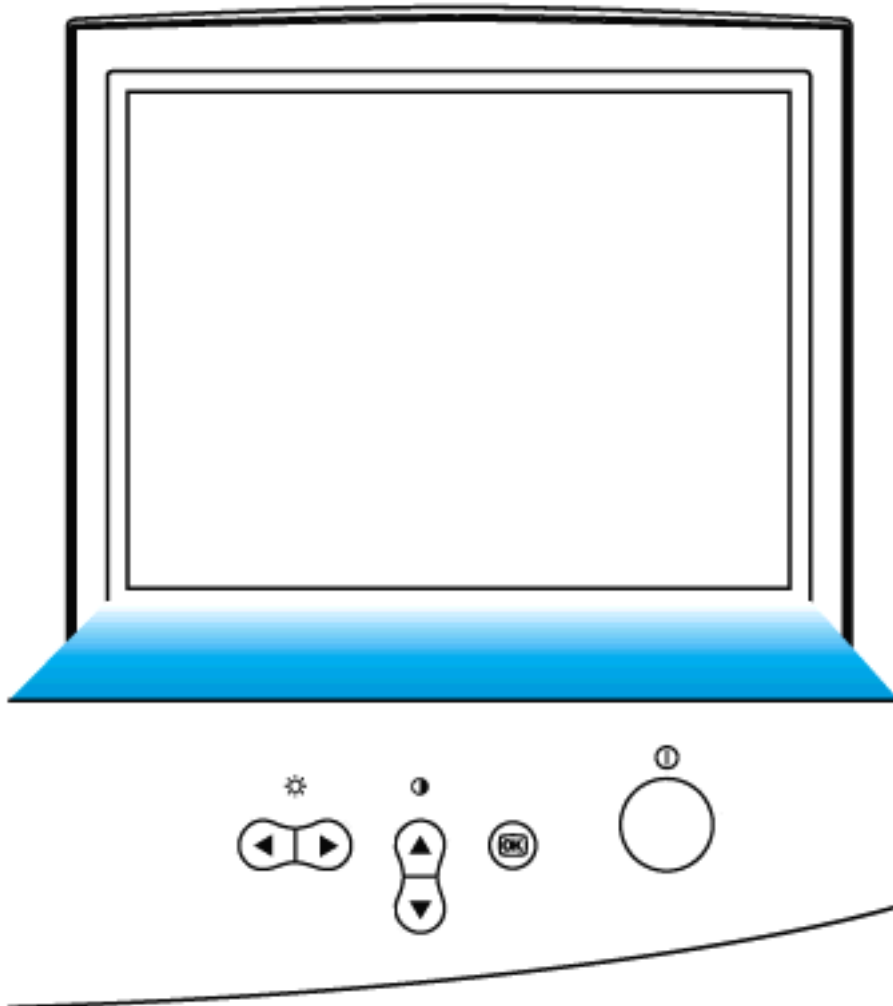

Power button switches your monitor on.



OK button which when pressed will take you to the OSD controls



Contrast hotkey. When the UP arrow is pressed, the adjustment controls for the CONTRAST will show up.



UP and DOWN buttons are used when adjusting the OSD of your monitor



Brightness hotkey. When the RIGHT arrow is pressed, the adjustment controls for BRIGHTNESS will show up.



LEFT and RIGHT buttons, like the UP and DOWN buttons, are also used in adjusting the OSD of your monitor.

[RETURN TO TOP OF THE PAGE](#)

---

**Rear View**

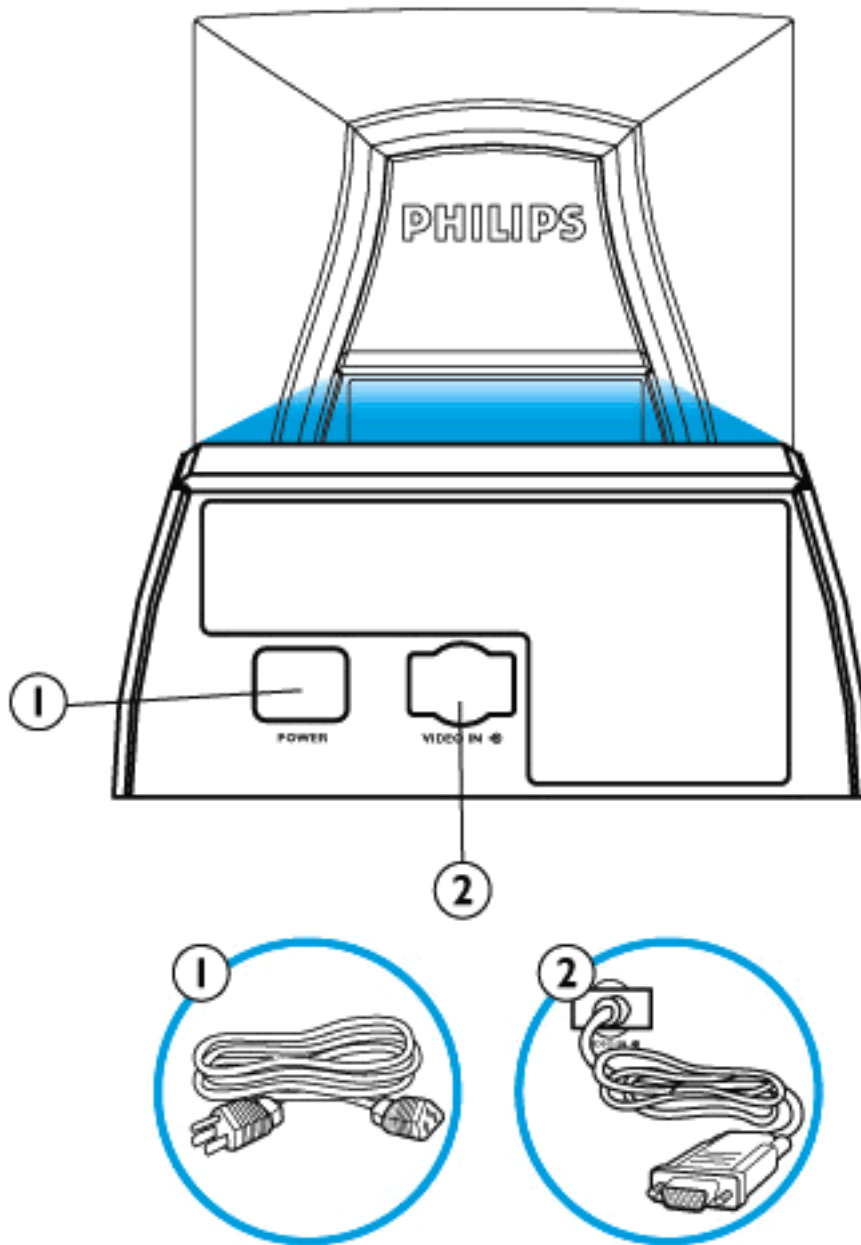

1. Power in - attach power cable here.
2. Video In - this is a cable which is already attached to your monitor. Connect the other end of the cable to your PC.

[RETURN TO TOP OF THE PAGE](#)

# On-Screen Display

[Description of the On-Screen Display](#) • [The OSD Tree](#) • [The OSD Controls](#)





---

## Description of the On Screen Display

### *What is the On-Screen Display?*

This is a feature in all Philips monitors which allows an end-user to adjust screen performance of monitors directly through an on-screen instruction window. The user interface provides user-friendliness and ease-of-use when operating the monitor.

### *Basic and simple instruction on the control keys.*

On the front controls of your monitor, once you press the  button, the On Screen Display (OSD) Main Controls window will pop up and you can now start making adjustments to your monitor's various features. Use the   or the   keys to make your adjustments within.

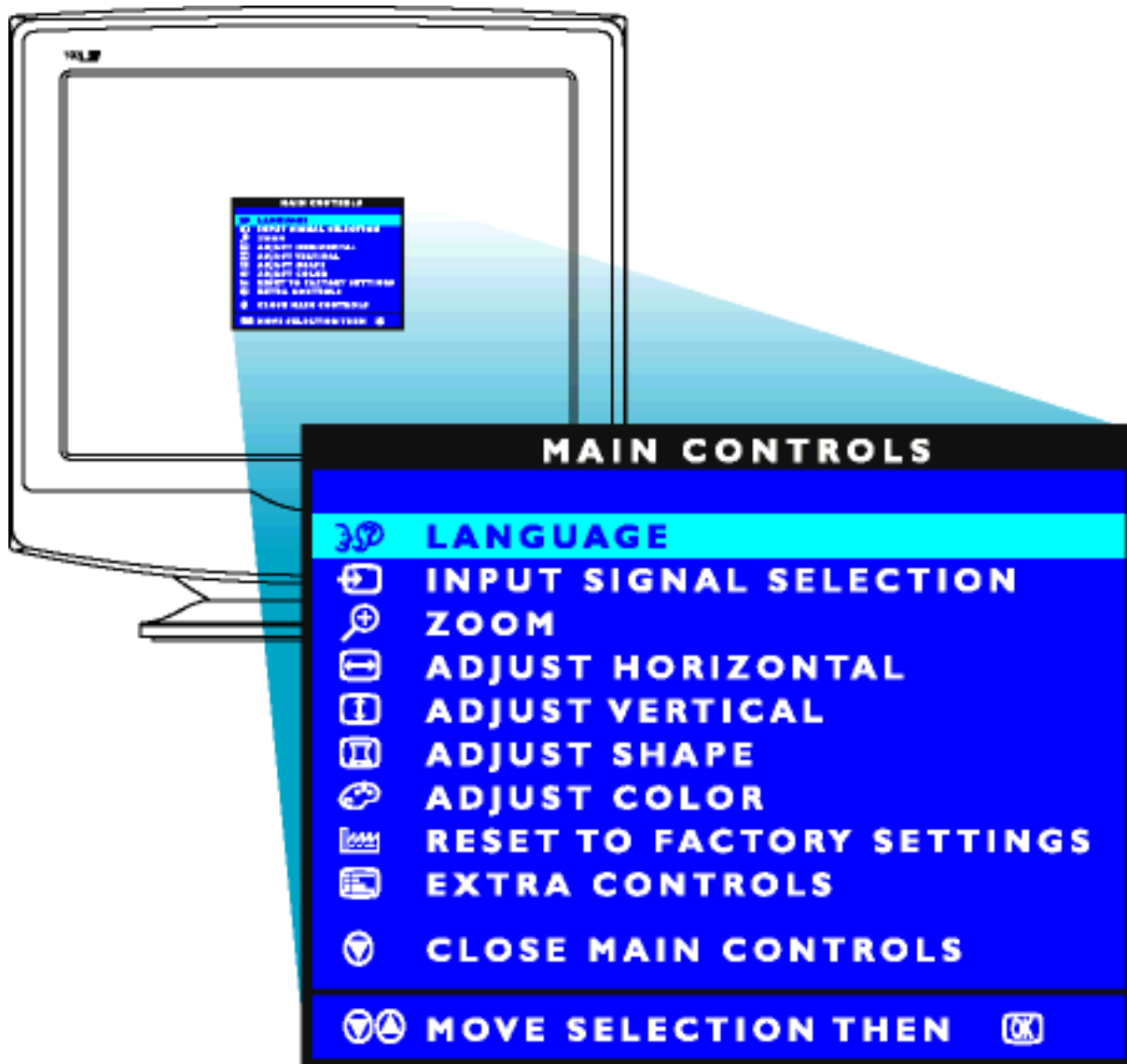

[RETURN TO TOP OF THE PAGE](#)

## The OSD Tree

Below is an overall view of the structure of the On-Screen Display. You can use this as reference when you want to later on work your way around the different adjustments.

## CRT OSD tree / English

**First Level**

**Second Level**

**Third Level**



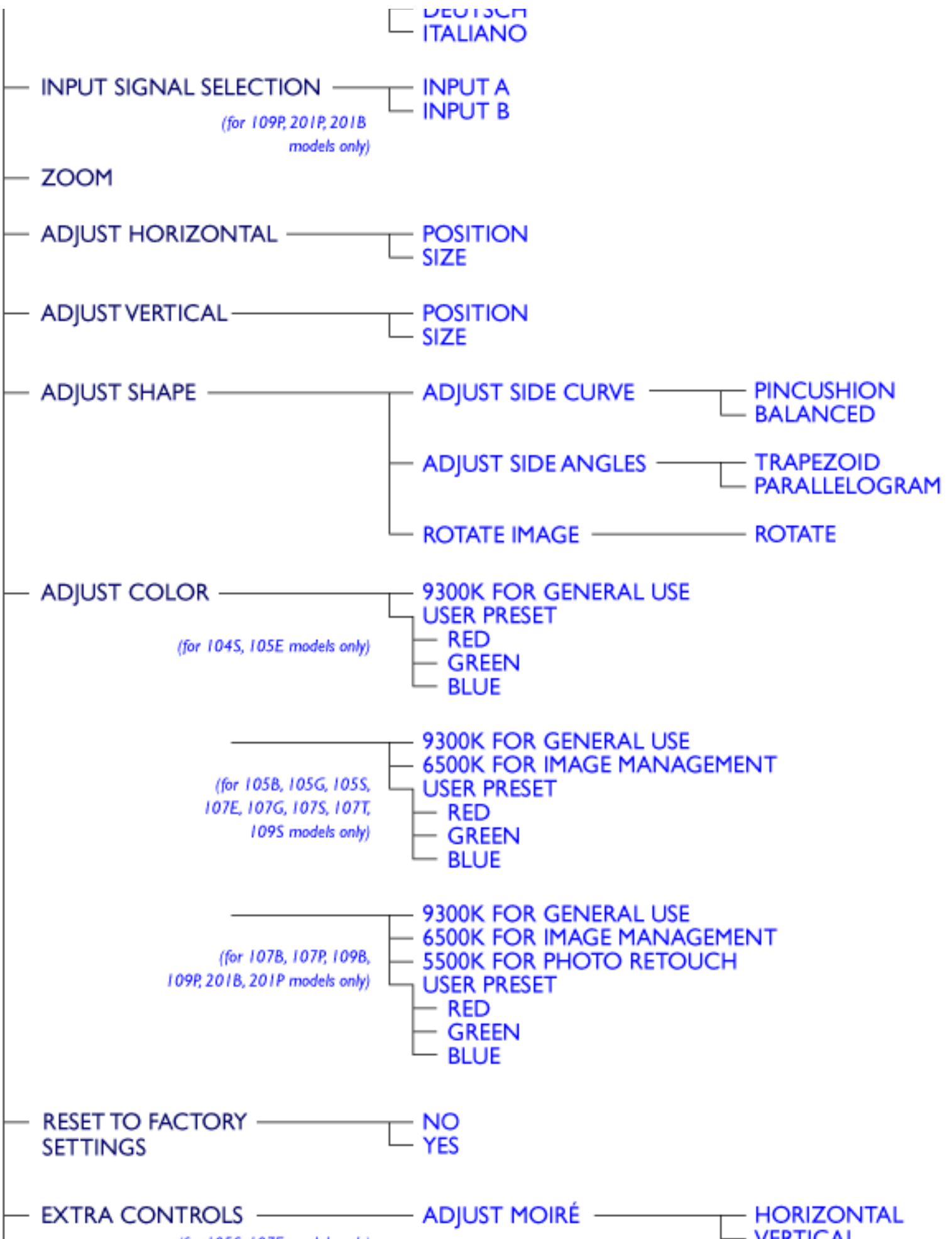

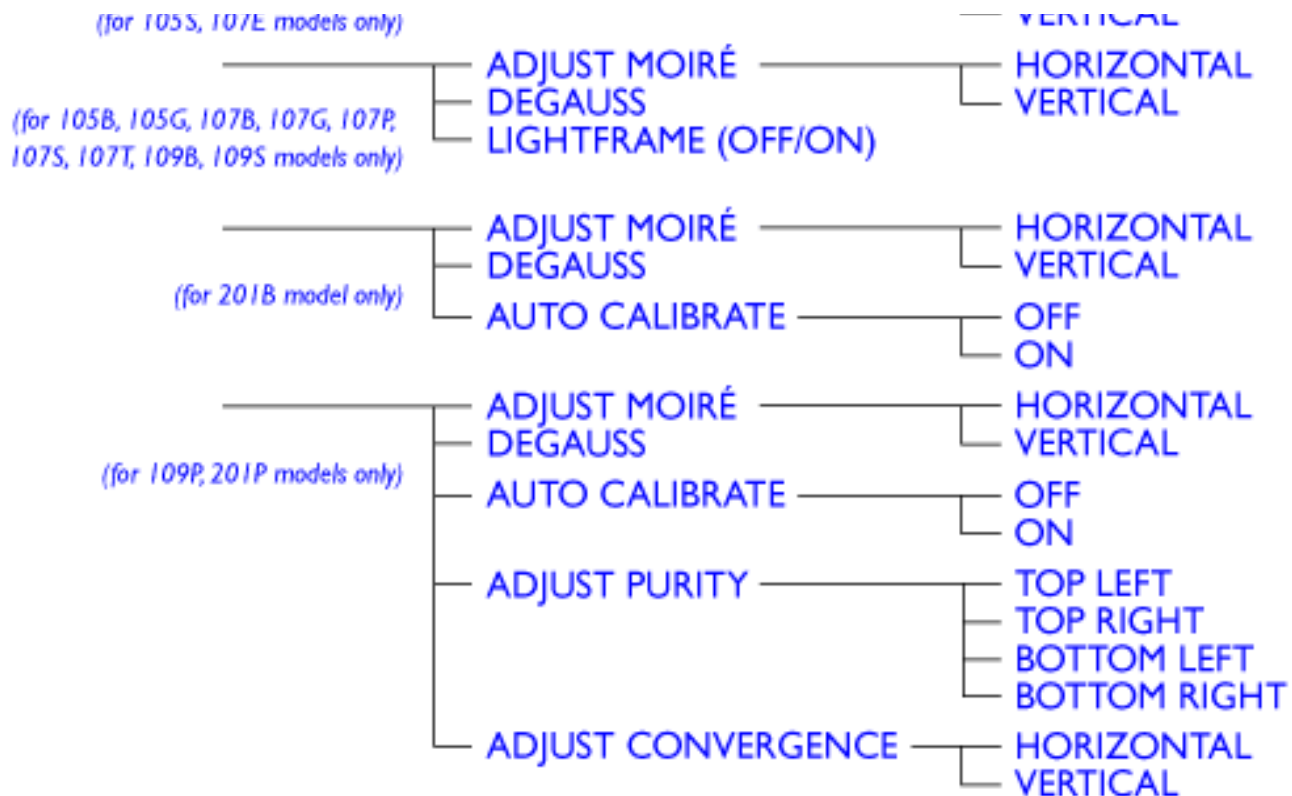

CLOSE MAIN CONTROLS

• Specifications are subject to change without prior notice.

[RETURN TO TOP OF THE PAGE](#)

# Customer Care & Warranty

PLEASE SELECT YOUR COUNTRY/AREA TO READ THE WARRANTY COVERED:

**WESTERN EUROPE:** [Austria](#) • [Belgium](#) • [Cyprus](#) • [Denmark](#) • [France](#) • [Germany](#) • [Greece](#) • [Finland](#) • [Ireland](#) • [Italy](#) • [Luxembourg](#) • [the Netherlands](#) • [Norway](#) • [Portugal](#) • [Sweden](#) • [Switzerland](#) • [Spain](#) • [United Kingdom](#)

**EASTERN EUROPE:** [Czech Republic](#) • [Hungary](#) • [Poland](#) • [Russia](#) • [Turkey](#) • [Bulgaria](#)

**LATIN AMERICA:** [Antilles](#) • [Argentina](#) • [Brazil](#) • [Chile](#) • [Colombia](#) • [Mexico](#) • [Paraguay](#) • [Peru](#) • [Uruguay](#) • [Venezuela](#)

**NORTH AMERICA:** [Canada](#) • [USA](#)

**PACIFIC:** [Australia](#) • [New Zealand](#)

**ASIA:** [Bangladesh](#) • [China](#) • [Hong Kong](#) • [India](#) • [Indonesia](#) • [Japan](#) • [Korea](#) • [Malaysia](#) • [Pakistan](#) • [Philippines](#) • [Singapore](#) • [Taiwan](#) • [Thailand](#)

**AFRICA:** [Morocco](#) • [South Africa](#)

**MIDDLE EAST:** [Dubai](#) • [Egypt](#)

---



## Frequently Asked Questions

### 1. What does the "Designed for Windows" logo signify?

The "Designed for Windows" logo means your Philips monitor fulfills the requirements and recommendations of the PC9x (97, 98, or 99) System Design Guide and passes stringent WHQL tests.

### 2. What is USB?

Think of USB as a smart plug for PC peripherals. USB automatically determines resources (like driver software and bus bandwidth) required by peripherals. USB makes necessary resources available without user intervention. Its three main benefits are:

- USB eliminates "Case angst," the fear of removing the computer case to install circuit board cards - that often require adjustment of complicated IRQ settings -- for add-on peripherals.
- USB does away with "port gridlock." Without USB, PCs are normally limited to one printer, two Com port devices (usually a mouse and modem), one Enhanced Parallel Port add-on (scanner or video camera, for example) and a joystick. More and more peripherals for multimedia computers come on the market every day. With USB, up to 127 devices can run simultaneously on a computer.
- USB permits "hot plug-in." No need to shut down, plug in, reboot and run set up to install peripherals. No need to go through the reverse process to unplug a device. Bottom line: USB transforms today's "Plug-and-Pray" into true Plug-and-Play!

### 3. What is a USB hub?

Think of USB hub as a extension of USB ports. Normally, the PC provides only one or two USB ports. To connect additional USB devices, you need a USB hub.

### 4. What is Philips Monitors USB hub solution?

Increasingly, monitors include USB hub functionality. But not all users need or want a USB hub. To give users freedom of choice, Philips provides an optional USB hub (type number PCUH411). The USB hub consists of two parts that are normally connected: one is functional, the other aesthetic. The aesthetic element is a removable cover. With the cover removed, the USB hub can be attached to the base or pedestal of monitor. The attached USB hub can be rotated to any position around the monitor's base. With this innovative Philips solution, your USB hub is always within reach for convenient connection and disconnection of USB peripherals.

### 5. Where can I buy a USB hub for my Philips monitor?

Philips provides an optional USB hub (type number: PCUH411) which can be attached to the base or pedestal of Philips monitors. Contact your dealer/reseller for details.

### 6. What models are Mac compatible?

All listed Philips monitors are Mac compatible. BUT, you may need an adapter to connect the monitor to your Mac system. Please contact your dealer/reseller for details.

## 7. What is TCO?

TCO is a Swedish abbreviation for the Swedish Confederation of Professional Employees.

## 8. What is MPR?

MPR is a Swedish abbreviation for the Swedish National Board of Measurement and Testing.

## 9. What are the differences between MPRII, TCO92, TCO95, and TCO99?

In the general hierarchy of standards, TCO99 is the highest level of certification. Next is TCO95, which is "better" than TCO92, which, in turn, is better than MPRII. Below, we compare the standards in each category.

### **Emissions:**

MPRII: Set low emission rules for visual displays.

TCO92: Imposed more stringent standards than MPRII.

TCO95: Further toughened TCO92 rules.

TCO99: Delineated even more severe standards and test procedures than TCO95.

### **Safety:**

MPRII: No requirement.

TCO92/95/99: All set requirements.

### **Energy Saving:**

MPRII: No requirement.

TCO92: Standby mode < 30W, Off mode < 8W

TCO95: Standby mode < 30W, Off mode < 8W

TCO99: Standby mode < 15W, Off mode < 5W

### **Visual Ergonomics:**

MPRII: No requirement.

TCO92: No requirement.

TCO95: Set ergonomic rules including minimum contrast level, flicker and jitter.

TCO99: Tightened TCO95 rules.

### **Ecology:**

MPRII: No requirement.

TCO92: No requirement.

TCO95: Set general ecological standards including recycling preparation, environmental policy and environmental certification.

TCO99: Further tightened TCO95 norms.

## 10. How do I enable the energy saving function?

Go to 'My Computer' and select 'Control Panel' followed by 'Monitor Control.' Select 'All default selection' and choose your Philips monitor model from the default driver list. Plug and Play will automatically enable the EPA tick box for you. In DOS or Windows 3.1, you must first make sure your PC supports power saving.

## **11. What is refresh rate?**

"Refresh rate" describes the number of times an entire screen is vertically scanned each second. In other words: If a monitor's refresh rate is 85 Hz, its screen is refreshed - or vertically scanned - 85 times per second. A higher the refresh rate means better image stability and less flicker. A high refresh rate helps users who work long hours in front of a monitor avoid eye fatigue and stress. To change the refresh rate, go into "Start/Settings / Control Panel / Display / Properties / Setting/Advance/Adaptor" Windows settings of the computer, the monitor will automatically adjust itself to the video card.

## **12. Why does the picture on the screen appear to flicker?**

A low refresh rate or electrical interference typically causes flickering in the picture. Possible solutions include the following:

- Verify that the proper drivers are installed for your video card.
- Make sure that all electrical devices (such as mobile phones) are at least 1m from the monitor
- Place the monitor in another physical location away from electrical interference
- Adjust the refresh rate to 75hz or higher.

## **13. How do I adjust my monitor's resolution?**

Available resolutions are determined by the capabilities of your video card and graphic driver. Under Windows '95, you may select the desired available resolution through the 'Display properties/Settings' menu.

## **14. How can I adjust the size, position and rotation of my screen?**

Depending on the model you own, you can use your CustoMax Software, On Screen Display (OSD) or control knobs located on the monitor.

## **15. What if I get lost when making monitor adjustments?**

Simply press OK button then select "Reset to factory settings" to restore all settings.

## **16. What is LightFrame™?**

LightFrame™ is a Philips technology breakthrough which offers a unique and revolutionary solution for boosting a monitor 's brightness and sharpness. With LightFrame™, the user experiences TV quality performance for video or photos without deterioration to the monitor 's performance in windows used for other applications.

## **17. How does LightFrame™ work?**

LightFrame™ consists of a software application and an Integrated Circuit (IC) embedded in the monitor. Together, they boost brightness and sharpness in a user defined window or screen area. Unique LightFrame™ technology dramatically improves photo and video display quality.

## **18. Why is LightFrame™ important to me?**

With LightFrame™, selected Philips monitors deliver TV quality video and photo display while maintaining monitor performance for text-based applications. The result is that movies and other video are brighter and livelier; photos are more vibrant and lifelike.

## **19. Will anyone else have this?**

LightFrame™ was invented, developed and patented by Philips. It is a unique feature that you will find exclusively in Philips monitors.

**20. Will LightFrame™ shorten the life of a monitor?**

No. Extensive testing has confirmed LightFrame™ does not adversely affect monitor life. Today's state-of-the-art Philips monitors employ improved phosphors and are designed for high light output. LightFrame™ normally highlights photos and videos. Though the peak brightness of the highlighted area is strongly increased, the average brightness - a determining factor for cathode deterioration - is not normally increased. In any case, a special Automatic Beam Limiter (ABL) circuit keeps a monitor's maximum average brightness within acceptable levels.

**21. I get a message warning that my monitor 'may not support LightFrame™'. I am certain my monitor does. What is wrong?**

Only a Philips driver can determine if your monitor is equipped with LightFrame™; a generic Windows driver cannot. Install the special Philips driver that came with your monitor. If the warning continues to flash after your Philips driver is installed, ignore the message. LightFrame™ will function properly.

**22. What will happen when my system is no longer connected to a LightFrame™ enabled monitor - for example, when I take my notebook on the road?**

Philips exclusive LightFrame™ feature requires the combined operation of hardware that resides in your monitor and software installed on your system. It only works when a monitor with built-in hardware receives commands from system software. Without both the LightFrame™ hardware equipped monitor and system software, the LightFrame™ does not function.

**23. What is "XtraSpace Design" (XSD)?**

XSD stands for XtraSpace Design, a Philips breakthrough that reduces a CRT display device's footprint. Philips XSD monitors combine the world's smallest front-to-back footprint with excellent front of screen performance.

**24. How did Philips achieve XtraSpace Design?**

Philips achieved this breakthrough in reduced footprint CRT display devices through short depth tubes and a focused design process that squeezed every excess millimeter out of XSD monitor desk space requirements.

**25. What is Philips monitors' solution for audio?**

Not all users need multimedia capabilities. To give users freedom of choice, Philips provides an optional Multimedia Base (type number: 6G3B10). The Multimedia Base replaces the easily removable standard pedestal of the monitor.

**26. Which models can be incorporated with the Multimedia Base?**

The following models can be incorporated with the Multimedia Base: 109B20, 107B20, 105B20, 105B21, 109S20, 107S20, 107S21, 105S20, 105S21.

**27. What are Philips Multimedia Base's specifications?**

See detailed Multimedia Base specifications on the product information page.

**28. Why is a Multimedia Base better than separate speakers?**

The major advantage of the Multimedia Base is its minimal space requirements. In fact, it hardly uses any extra space at all: monitor depth and width are unchanged. Only the monitor's height is increased by only 3 centimeters.

**29. Where can I buy a multimedia base to incorporate with my Philips monitor?**

Please contact your dealer/reseller for details.

### **30. What does Auto Calibrate do?**

It makes your monitor perform better and last longer. As a monitor becomes older, brightness gradually deteriorates and its colors change. This well-known process effects all monitors. Eventually after a number of years, the monitor's brightness deteriorates to below 50% of its original value. At this stage, the usable life of a monitor is considered ended. Auto Calibrate regularly readjusts color temperature and luminance to their original values.

### **31. How does Philips Auto Calibrate feature benefit me?**

With Auto Calibrate, it takes a monitor's luminance 33 percent longer to deteriorate to the 50 percent level that marks the end of a display device's useful life. Thanks to Auto Calibrate, a monitor with a normal life of 10,000 hours, for example, would last for 13,300 hours, a full one third longer.

### **32. How does Auto Calibrate work?**

During the calibration process, different predefined black and white images are displayed on the screen. The beam currents of the red, green and blue cannons are accurately measured and compared to the original values stored in the monitor. By readjusting gain values of the individual cannons, deviation is reduced to zero. Default values are stored during production. If the user sets a new color temperature, this new value is saved as the new default value.

### **33. When should calibration be performed?**

The calibration process takes less than six seconds. During this period, different specific images are displayed. After the process is finalized, the original image is redisplayed. Constant re-calibration is not required. Calibration should be performed after the monitor is warmed up. Auto Calibration takes place when a monitor receives a signal indicating an imminent switch to its sleep mode/stand-by mode.

### **34. Which models of Philips monitors are equipped with Auto Calibrate feature?**

Auto Calibrate is currently available in the new 201P, 201B and 109P.

### **35. The Main Menu displays OSD MAIN MENU LOCKED . Pressing the front control panels has no effect. How can I unlock this function?**

Press and hold the OSD menu key for about 10 seconds until picture displays "OSD MAIN MENU UNLOCKED"

### **36. My screen shows NO SYNC INPUT , how can I get rid of this?**

Check the following for possible solutions:

- Bent pins on the video cable
- Make sure the computer is turned on
- Ensure the VGA Cable is properly connected
- Ensure the BNC/D-Sub connector on the rear of the monitor is in the correct position, newer models have this option in the On Screen Display under Input Signal Selection.
- Video card may be not be a VESA standard (try the monitor with another computer)

### **37. Why does my monitor display "Out of Range"?**

The video card installed in your computer may be too high for the monitor 's specifications. Please contact your

computer manufacturer for details on how to lower resolution for your operating system.

### **38. What is Moiré? Why does my monitor have this wavy phenomenon?**

Moiré is a natural effect or phenomenon of CRT that has the appearance of a wavy pattern, which is repetitive and superimposed on the screen as ripple images. These are a few suggestions to help reduce or minimize the effects:

- Some monitors have a Moiré cancellation feature, activate it to the on position or adjust the Moiré cancellation function via the OSD on the monitor.
- Change resolution to the recommended standard for the specific monitor size.
- Change Window viewing pattern/scheme to a pattern where the Moiré is less visible.
- Change horizontal and vertical size to optimize the reduction of the Moiré effect.

### **39. What is CustoMax?**

CustoMax is proprietary Philips software that allows user to control parameter (e.g. Size, Color, Geometry) in place of the buttons on the front of the monitor. To install and run the CustoMax software, you must have a USB compatible system and have a USB connection at the rear of your monitor.

### **40. My monitor appears to be missing one or more colors. How do I correct this?**

- If the OSD menu is also missing a color, please contact service for details
- Set color temperature to 9300 color coordination
- Check the video cable for any bent pins
- Video card could be defective (try the monitor with another computer).

### **41. When I degauss my monitor, it makes a loud noise. Is this normal?**

Yes, when degaussing your monitor via the OSD, it is normal for the monitor to make a relatively loud noise. Please be aware that many models will not degauss more than once within any given time period (up to 10 minutes). This is due to the unit having a temperature sensitive resistor. While the unit is degaussing, the resistor increases in value with heat and once it reaches a certain temperature, the resistance will rise and prevent voltage from reaching the degaussing coil. This is what stops the degausser, and this device's resistance will decrease as it cools back off, enabling the degauss function to operate again. This is an intentional design and is an industry standard, not just for Philips monitors. Please be aware that not all models in the Philips range has this manual degauss function. Some models are built with an auto degauss feature which automatically degausses the monitor when it is switched on.

### **42. How do I adjust the picture on the screen?**

Please perform the following to correct the picture image:

- Reset your monitor via the OSD menu
- Adjust the Horz (width) and/or Vert size (height) in the OSD
- Change monitor timing to work at the recommended resolution

### **43. The edge of the picture on the screen appears to be distorted. How can I correct this?**

Please perform the following to correct the picture image:

- A magnetic or electrical interference typically causes poor geometry in the picture. Place the monitor in a different physical location
- Reset the monitor to the factory preset via the OSD menu
- Access the Geometry Menu in the OSD of the Monitor and perform the necessary adjustments
- Change the monitor timing to the recommended resolution

### **44. The picture appears too dim. How can I correct this?**

Adjust Brightness and/or Contrast via the monitor's OSD. Some models have a Video Input Select

under Advanced Controls in the monitor 's OSD. Most computers require it to be set at .7V.

Please review the following for possible solutions:

- If the OSD menu is also dim, please contact service for repair
- Reset the monitor via the OSD menu
- Change the color temperature settings to 9300 color coordination via the OSD menu
- Set the Contrast to maximum level (100) and Brightness to middle level (50)

Video card could be defective (try the monitor with another computer)

#### **45. I have noticed two thin horizontal lines on the screen of my Philips monitor. Is this normal?**

This phenomenon can occur with Philips 107P, 109P and 201P monitors and is normal. Your monitor is using an Aperture Grille, which consists of fine vertical wires to align the electron beams with the phosphors on the screen. To prevent these vertical wires from vibrating and to keep them properly aligned with the picture tube, two horizontal damper wires are required. These are located on one-third and on two-third from the top of the screen. The result is that you will see two very thin horizontal lines over your screen since the two wires are casting a slight shadow on the screen surface. You will find these wires (line) in any monitor from Philips and other brands using the Aperture Grille technology.

#### **46. How can I increase the color display of my monitor?**

The amount of video memory your video card holds determines the amount of colors that can be displayed on your computer screen. To get the most out of your video card, you will need to either install the latest drivers onto your computer or upgrade the video cards memory. Please check with your computer or video card manufacturer for further details.

#### **47. Why is there no picture on my monitor?**

- Check the wall socket for power. Verify that there is power by connecting another product.
- Ensure the power cable is correctly attached to both the wall socket and the monitor.
- Check that the power button is switched on.
- Unplug the monitor for approx. 1 minute and plug it in again. Switch the monitor back on.

#### **48. Why is there is no picture on my monitor even though the power LED is yellow/amber?**

- Reboot your computer while holding the Ctrl key on your computer. If you see any picture during the boot procedure, please verify the settings of your video card (for Windows go to Control Panel and select Display).
- Check that the video cable is not damaged, bent or that any of the pins in the connector are damaged (please be aware that all VGA connectors have one missing pin). If damaged, replace with a new cable.
- Check that the cable is attached correctly to the computer.
- Press any key on the keyboard to wake-up the computer from power saving mode.

#### **49. Why is there no picture on my monitor even though the power LED is green?**

- Verify the Contrast and Brightness setting of the monitor. First press and hold the 5 button to increase Contrast and then press and hold the 4 button to increase Brightness. These buttons are located on the front of your monitor.
- Press both the 5 button and the OK button at the same time to switch input A|B.
- Try and repeat step 48 above.

#### **50. Why does the picture disappear after I press the on/off button quickly?**

This is a unique Philips feature designed to preserve the life of your monitor. Please allow 5 seconds between powering off and on your monitor, your picture will then be restored.





# Glossary

[A](#) [B](#) [C](#) [D](#) [E](#) [F](#) [G](#) [H](#) [I](#) [J](#) [K](#) [L](#) [M](#) [N](#) [O](#) [P](#) [Q](#) [R](#) [S](#) [T](#) [U](#) [V](#) [W](#) [X](#) [Y](#) [Z](#)

## A

### *Autoscan*

A microprocessor-based feature of Philips Brilliance monitors is able to detect automatically horizontal and vertical frequencies of input signals with those of the installed video card. An autoscan monitor can thus operate with a wide range of video cards. MultiSync, a registered trademark of NEC, provides a similar function.

[RETURN TO TOP OF THE PAGE](#)

## B

### *Balanced pincushion*

See Geometric distortion

### *BNC connection*

A special construction of connector used in some monitors with higher horizontal scanning frequency. The BNC connection can provide the optimum shielding and matching characteristic impedance of video signal path to ensure the best video performance.

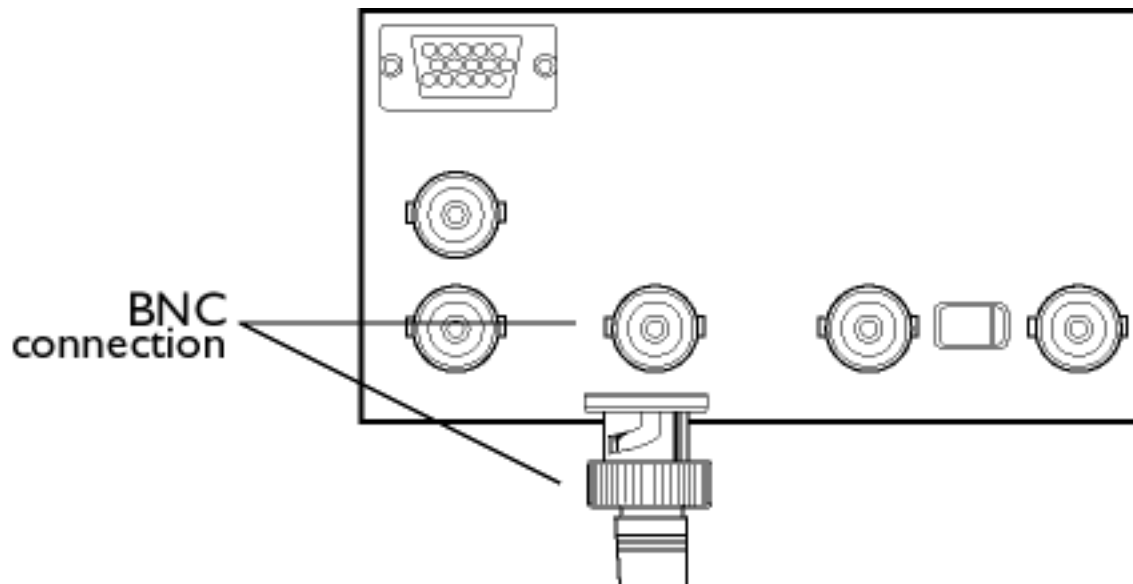

[RETURN TO TOP OF THE PAGE](#)

**C***CE Mark*

CE mark is displayed on products per EMC and LV ( low Voltage Device ) directives in compliance with European Community safety, EMI and EMS requirements and is compulsory on products for sale in the European Community.

*Color temperature*

A way of describing the color of a radiating source in terms of the temperature (in degrees Kelvin) of a black body radiating with the same dominant frequency as the source.

Most Philips monitors offer the possibility of setting the color temperature to any desired value.

*Contrast*

The ratio between the brightness of the brightest and darkest parts of a picture. The darkest part of a picture is set by the brightness of the unexcited phosphor, which is governed by the degree with which ambient light is reflected. Contrast is therefore reduced in conditions of high ambient light levels. Black Matrix tubes reflect less ambient light so exhibit higher contrast than other tubes.

*Convergence error*

Beam misalignment causing one or more of the three beams passing through the wrong aperture in the shadow mask and striking a phosphor dot in the wrong triad.

Convergence error is expressed in mm often at three well-defined points on the screen, designated A, B and C (see figure ). Also known as misconvergence.

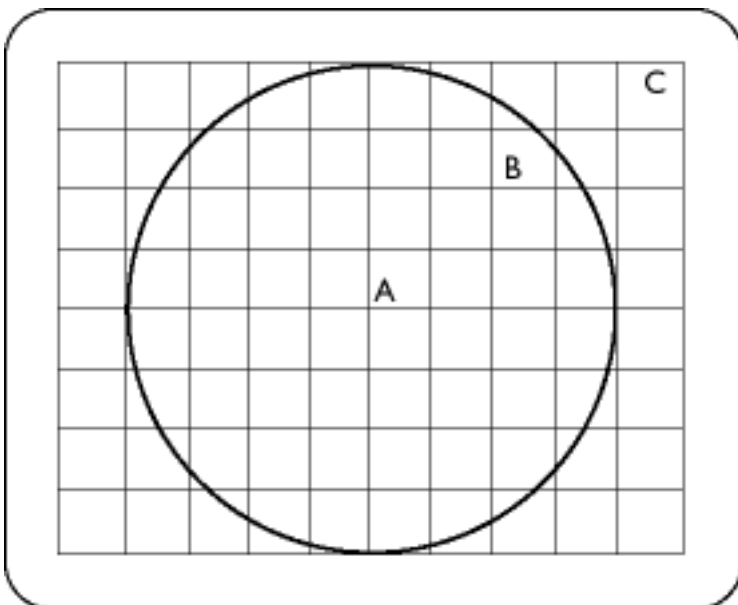

*Points where convergence error is specified.*

### *Convergence-error correction*

A method of correcting for convergence error to insure that all three beams land simultaneously in the same triad. This is usually accomplished by means of special convergence-error correction coils in the deflection yoke.

### *CRT*

Cathode-ray tube - the general term for all tubes in which one or more electron beams emitted by a cathode are periodically scanned across a phosphor screen by means of deflection circuitry. A special form of the cathode-ray tube is the TV and monitor picture tube.

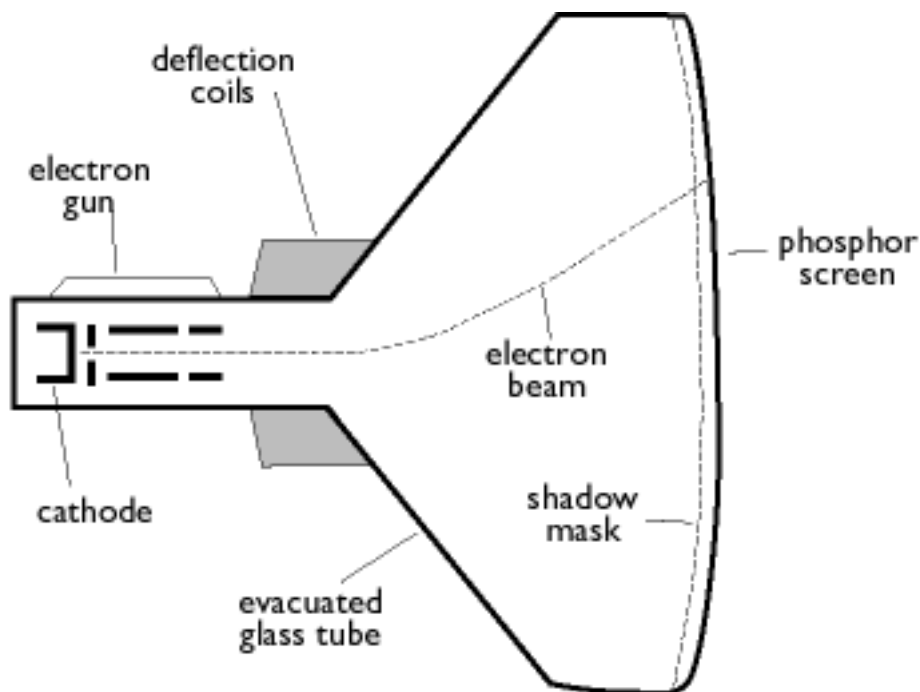

### *CustoMax*

Philips proprietary monitor control software that allows users to control parameters (e.g., Size, Color, Geometry) using software running in Windows. CustoMax is compatible with existing VGA cards. See CrystalClear FAQ and USB Bay FAQ.

[RETURN TO TOP OF THE PAGE](#)

## **D**

### *DDC (Display Data Channel)*

DDC is a communication channel for displays and computers. The DDC feature allows the monitor controller to be automatically configured to make optimal use of the display without manual user interaction. DDC is implemented as part of the new Plug & Play approach introduced into the PC market to increase user friendliness.

The three levels developed for Plug & play are: (1) DDC1, monitor send data to the PC; (2) DDC2B, PC can request information from monitor; and (3) DDC2Bi which is a two-way communication - monitor can be addressed and PC or graphics board can give commands to monitor.

### *DDC 1/2B*

See DDC.

### *DDC 2Bi*

See DDC.

### *Degaussing*

The procedure of demagnetizing the shadow mask and associated metal parts of a picture tube at switch-on to minimize picture distortion. This is usually accomplished by means of a special degaussing coil through which a decaying alternating current is passed to generate an alternating magnetic field that gradually decays to demagnetize the tube. Some monitors offer a manual degaussing facility that can be activated at any time.

### *Digital control*

Microprocessor-based digital control of picture parameters and video modes for complete control of picture settings and modes and instant recall of all settings at the push of a button. This is a very advanced feature that allows the user to switch to any required mode at any instant without having to spend time readjusting the picture. It is currently available in most Philips monitors.

### *Dot pitch*

The shortest distance between two phosphor dots of the same color on the screen. The smaller the dot pitch, the better the resolution of the monitor.

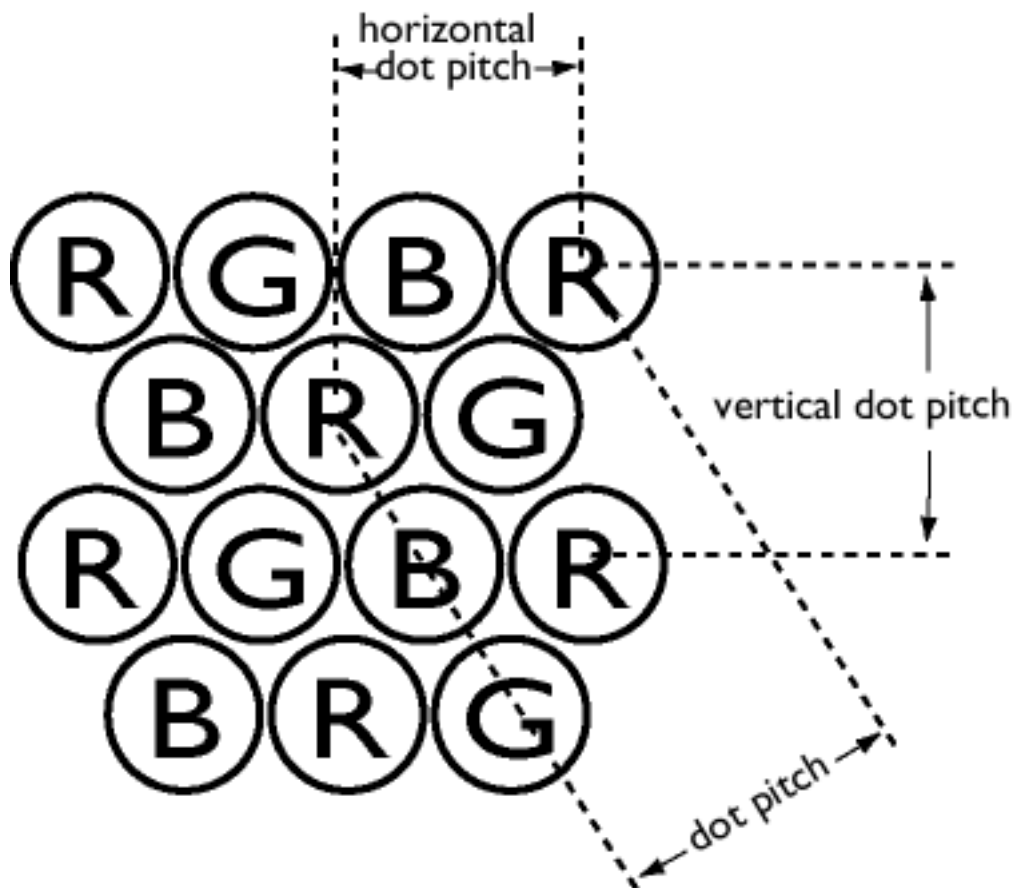

### *Dot rate*

Frequency in MHz of the dot clock. It is a measure of the speed with which data is transferred between the video card and subsequent processing circuitry.

Also known as video dot rate.

[RETURN TO TOP OF THE PAGE](#)

## **E**

### *Electromagnetic radiation standards*

International standards set to limit electromagnetic emissions from monitors. There are currently two important standards both derived from regulations originally laid down by Swedish authorities.

#### **MPR-II**

The standard originally proposed by the Swedish National Board of Measurement and Testing. It set maximum levels of electromagnetic radiation emitted by monitors, and has now been adopted as a world standard. MPR-II defines maximum permitted electrostatic, magnetic and electric field levels measured at a distance of 50 cm from the center of the monitor (see table).

#### **TCO**

In 1991, the Swedish Tjänstemannens Central Organization (TCO, Swedish confederation of Professional Employees ) set a standard even more severe than MPR-II, especially for alternating electric fields (AEF). The TCO standard is more severe since not only are the permitted field levels reduced compared with MPR-II, but the measuring distance is also reduced (see table).

### **Electromagnetic radiation standards**

#### *EMI (Electrical Magnetic Interference)*

The electrical and/or magnetic radiation coming from the working electrical or electronic equipment.

#### *EMS (Electrical Magnetic Sustainment)*

The ability of electrical or electronic equipment to function properly in the environment with electrical and/or magnetic interference.

[RETURN TO TOP OF THE PAGE](#)

---

## **F**

### *Flicker*

Very rapid variations in picture intensity caused by the finite time required for the electron beam to scan a picture onto the screen. Two kinds of flicker occur: line flicker caused by the electron beam scanning-in each line of the picture; and frame flicker (or field flicker if the picture is interlaced) caused by the frame repetition rate of 50 frames/second. Frame flicker is noticeable with GUI and DTP software (which have a light background), and can be very disturbing, especially for those who work regularly with displays - contributing to eye strain, headaches, visual blurring, stress, etc. The problem can, however, be eliminated by increasing the refresh rate (number of frames/second) of the monitor to a value above around 70 Hz. Sensitivity to flicker appears to diminish with increasing age.

[RETURN TO TOP OF THE PAGE](#)

---

## **H**

### *Hertz*

The unit of frequency named after the physicist Heinrich Hertz (1857-1894). 1 hertz (Hz) is equal to 1 cycle/second.

### *Horizontal dot pitch*

See Dot pitch.

### *Horizontal scanning frequency*

Also called line frequency and expressed in kHz, it is the number of video lines written on the screen every second (from left to right). The higher the horizontal scanning frequency, the better the resolution (i.e., the higher the resolution and/or the higher the refresh rate).

[RETURN TO TOP OF THE PAGE](#)

---

## INF File

### INF file (Information File)

Information (INF) files store information in a specific format. The set-up functions retrieve information from the INF file to use when performing installation operations. Examples of the type of information stored in an INF file include INI and registry changes, file names, and locations of the source files on source media.

## Interlaced/non-interlaced

### Interlaced.

The method of writing a picture on the screen by initially writing all even lines and subsequently writing all odd lines of the picture. Result: The complete picture is composed of two interlaced half pictures (or fields). With interlacing, a vertical (or field) frequency of 50 Hz means a picture (or frame) frequency of 25 Hz.

### Non-interlaced.

The method of writing a picture on the screen by successive video lines of the picture so that a full frame is written onto the screen in one vertical sweep of the beams. With a non-interlaced display, a vertical frequency of 50 Hz means a picture (or frame) frequency of 50 Hz. At any given resolution, non-interlaced modes are preferable to interlaced modes; however, generation of non-interlaced modes is more expensive.

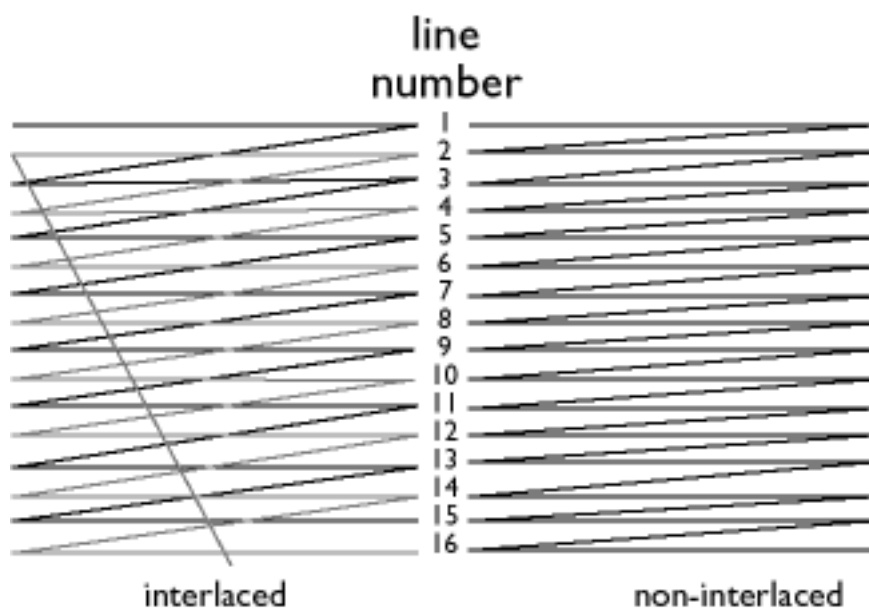

[RETURN TO TOP OF THE PAGE](#)

**L***Linearity*

The degree to measure the actual location of a pixel on the screen corresponds with its intended location. ( see figure )

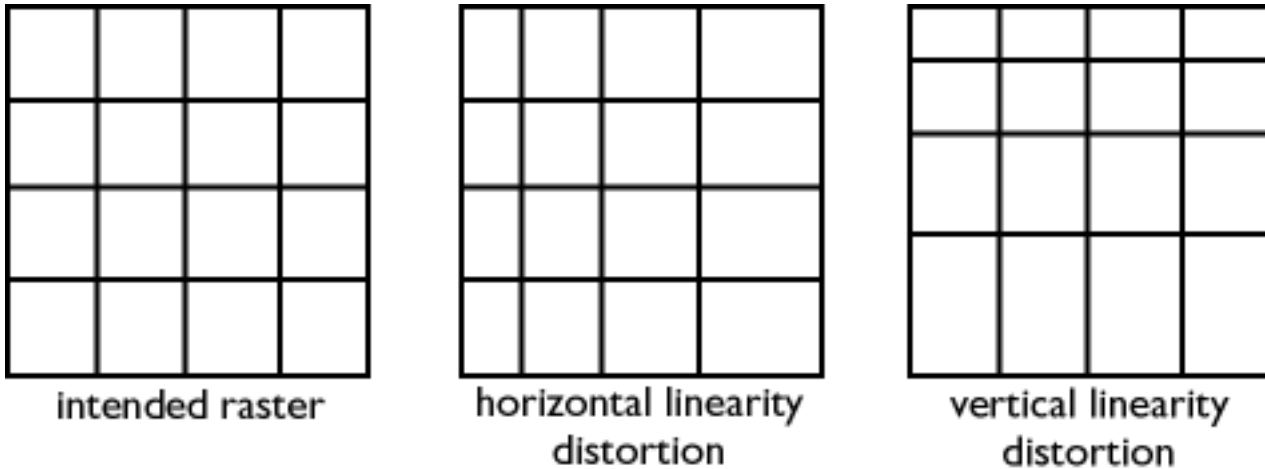
*Line frequency*

See Horizontal scanning frequency.

*Low-emission monitor*

A monitor that complies with international standards on radiation.

See Electromagnetic radiation standards.

*Low-frequency electric and magnetic fields*

Alternating fields generated by the deflection yoke. These are subject to increasing attention, notably by governing authorities, the trade and the press. Although there is no scientific evidence that monitor emissions are harmful, much effort has gone into reducing emissions on the principle of better safe than sorry. Currently, there are two areas of interest: very-low frequency (VLF) electric and magnetic fields extending from 2 kHz to 400 kHz, and extreme low frequency (ELF) fields extending from 5 Hz to 2 kHz.

See also *Electromagnetic radiation standards*.

[RETURN TO TOP OF THE PAGE](#)

---



## M

### *Moiré effect*

A fringe pattern arising from the interference between two superimposed line patterns.

In a monitor it comes from the interference between the shadow mask pattern and the video information (video moiré), and between the shadow mask pattern and the horizontal line pattern (scan moiré). It shows itself as wavy patterns on the screen and becomes more noticeable as monitor resolution increases. Since the video signal varies continuously, little can be done about video moiré. Scan moiré depends on the horizontal scanning frequency and can be alleviated by appropriate choice of frequency. Autoscan (MultiSync) monitors, which operate over a range of scanning frequencies, may sometimes exhibit moiré in certain video modes.

### *MPR*

See Electromagnetic radiation standards.

### *MultiSync monitor*

See Autoscan monitor.

[RETURN TO TOP OF THE PAGE](#)

---

## N

### *Non-interlaced*

See Interlaced/non-interlaced.

[RETURN TO TOP OF THE PAGE](#)

---

## O

### *OSD (On Screen Display)*

The feature that allows an end user to adjust screen performance and parameters of monitors directly through an on-screen instruction window. See CustoMax in CrystalClear section.

### *Overscan*

The practice in which areas without useful video information are scanned outside the visible screen area in order to make maximum use of the screen for display of active video information. This practice is occasionally necessary because some video cards generate a video pattern that is smaller than the visible

screen area, resulting in an image that is smaller (and less legible) than it needs to be.

[RETURN TO TOP OF THE PAGE](#)

---

## P

### *Parallelogram Distortion*

See Geometric distortion.

### *Phosphor*

Generic name for the class of substances that exhibit luminescence. To produce a picture on screen, phosphors are deposited on the inner surface of the picture-tube screen and excited into luminescence by the electron beam. Typical examples of phosphors are P22 medium short-persistence phosphor and EBU high-color-saturation phosphor.

### *Pin-cushion Distortion*

See Geometric distortion.

### *Pixel*

Abbreviation for picture element, the smallest element of the picture that can be displayed on the screen. The smaller the pixel size, the better the resolution of the monitor. Pixel size is determined by the size of the electron spot on the screen and not necessarily by the phosphor dot pitch (the size of the triad). Thus, a monitor with a large electron spot covering several triads can exhibit poor resolution even though its dot pitch is small.

### *Pixel frequency*

The number of pixels that can be written in a video line per second.

### *Pixel rate*

See pixel frequency

### *Plug-and-Play*

See DDC. See USB section.

[RETURN TO TOP OF THE PAGE](#)

## R

### *Raster*

The area on screen that electron beam can reach.

### *Refresh rate*

See Vertical scanning frequency.

### *Resolution*

The number of pixels that can be displayed on the screen. The resolution is specified as the number of pixels in a line multiplied by the number of horizontal lines.

See also video graphic adapter.

### *Rotation function*

The feature that allows users to adjust the whole screen rotating to be horizontal.

Because of the magnetic field of earth, the screen of monitor will be tilt when the screen faces toward the different direction.

[RETURN TO TOP OF THE PAGE](#)

---

## S

### *Screen coatings*

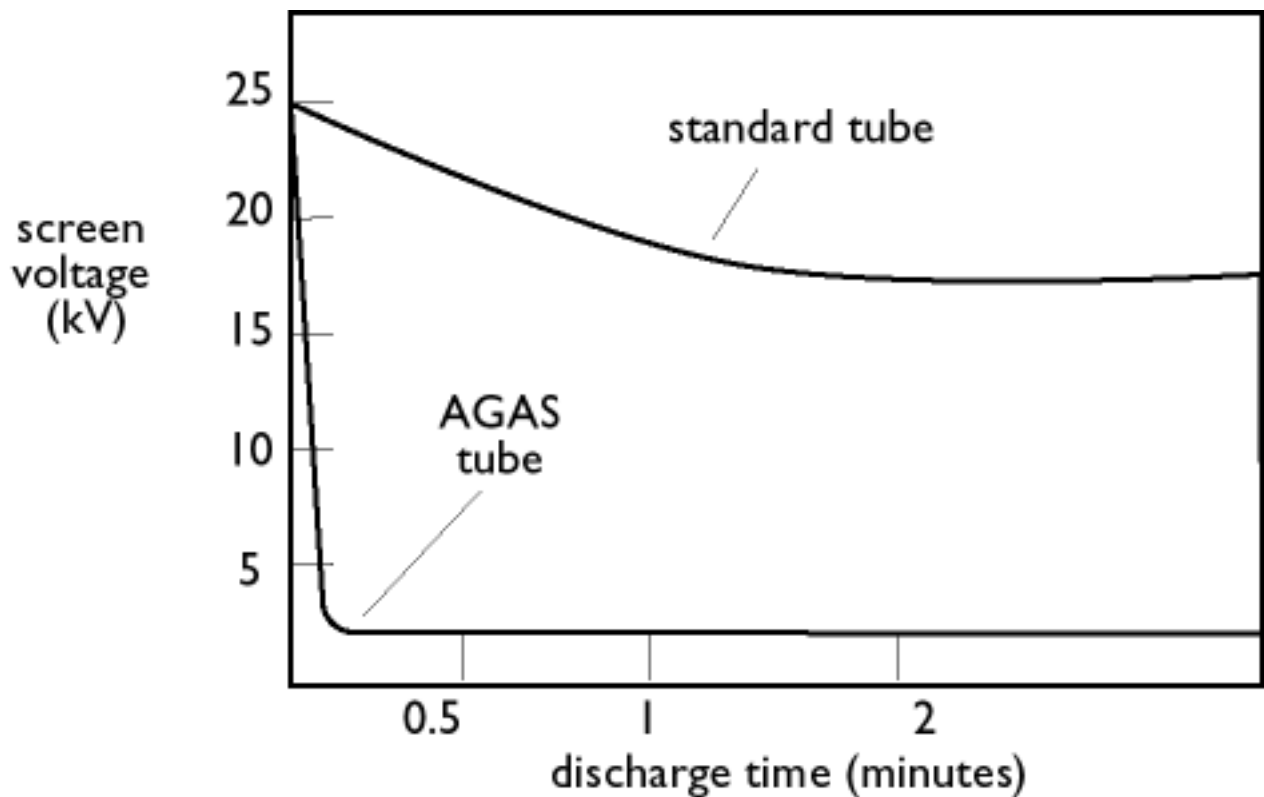

### *Anti-Static coatings*

Due to bombardment by beam electrons, monitor screens become electrically charged when in use. Electrically charged screens surfaces can attract dust particles. An Anti-Static coating is a conductive coating deposited on the screen (or on a glass panel immediately in front of the screen) that conducts away the charge and prevents screen dust build-up.

### *AGAS (Anti-Glare, Anti-Static) coating*

AGAS is a silica coating applied to the surface of the screen by a spinning and spraying process. It operates by diffusing reflected light to blur images of light sources on the screen. To provide anti-static properties, the coating is impregnated with small conductive particles.

### *ARAS (Anti-Reflection, Anti-Static) coating*

ARAS is one of the most effective anti-reflection/anti-static screen treatments currently available. It is composed of a multi-layer structure of transparent dielectric material that suppresses specular reflections by broadband interference effects at the screen surface. Anti-static properties are provided by a single conductive layer within the multi-layer structure.

With ARAS, the intensity of reflected light is reduced from around 4.5% of the incident light (the reflectivity of uncoated screens) to less than 0.5%. ARAS also has a major advantage over other screen treatments: It doesn't diffuse or scatter reflected light, so picture contrast and sharpness remain completely unimpaired. It's also easy to clean and tough enough to withstand commercially available cleaning agents.

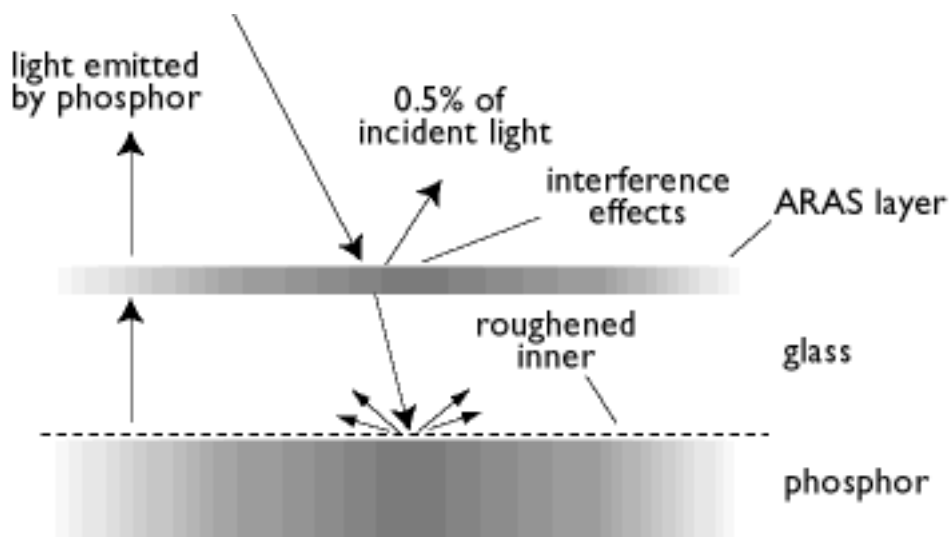

*The ARAS coating reflects only about 0.5% of the incident light.*

*AGRAS (Anti-Glare anti-Reflection Anti-Static) coating.*

A combined anti-reflection, anti-glare, anti-static coating.

### *Self-test function*

A monitor equipped with hardware or software to automatically detect cable connection status.

### *Shape*

Deviation of a reproduced picture from its intended shape. The following types of distortion are most common:

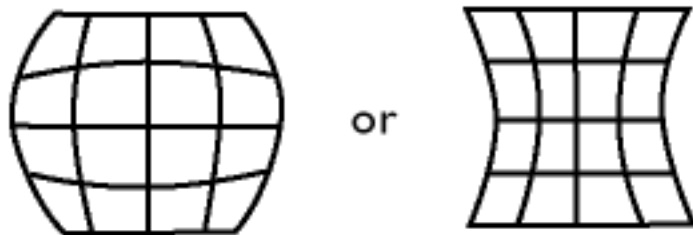

pincushion distortion

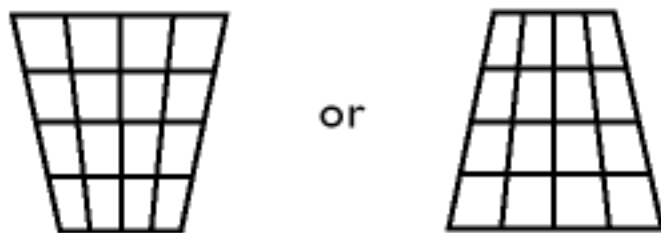

trapezoid distortion

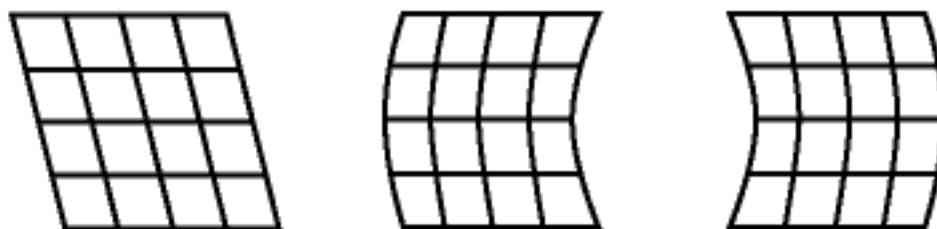
parallelogram  
distortionbalanced pincushion  
distortion

### *SOG (Synchronization On Green)*

A properly functioning color monitor requires five kinds of signals: horizontal sync pulse, vertical sync pulse, red color signal, green color signal and blue color signal. Signals from a PC are transmitted to a monitor using one of three methods:

1. Separate sync: Horizontal and Vertical sync signals transmitted separately
2. Composite sync: Horizontal and vertical sync pulses mixed into a single signal train.
3. SOG: Horizontal and vertical sync pulses mixed, then combined with the green color signal.

[RETURN TO TOP OF THE PAGE](#)

## **T**

### *TCO*

See Electromagnetic radiation standards.

### *Tilt function*

See rotation function.

### *Trapezoid distortion*

See Geometrical distortion.

### *TTL signal*

A TTL (Transistor-transistor-logic) signal is a digital signal level for controlling the screen colors. With TTL driving, the red, green and blue signals can only be switched on or off or provided with an intensity signal. A TTL-driven monitor can thus display a maximum of 64 colors. Video standards such as MDA, CGA and EGA are based on TTL level.

[RETURN TO TOP OF THE PAGE](#)

---

## U

### *USB or Universal Serial Bus*

[A smart plug for PC peripherals.](#) USB automatically determines resources (like driver software and bus bandwidth) required by peripherals. USB makes necessary resources available without user intervention.

- USB eliminates "case angst" -- the fear of removing the computer case to install add-on peripherals. And USB also eliminates adjustment of complicated IRQ settings when installing new peripherals.
- USB does away with "port gridlock." Without USB, PCs are normally limited to one printer, two Com port devices (usually a mouse and modem), one Enhanced Parallel Port add-on (scanner or video camera, for example) and a joystick. More and more peripherals for multimedia computers arrive on the market every day. With USB, up to 127 devices can run simultaneously on a computer.
- USB permits "hot plug-in." There's no need to shut down, plug in, reboot and run set-up to install peripherals. And no need to go through the reverse process to unplug a device.

In short, USB transforms today's "Plug-and-Pray" into true Plug-and-Play!

### Hub

A Universal Serial Bus device that provides additional connections to the Universal Serial Bus.

Hubs are a key element in the plug-and-play architecture of USB. The Figure shows a typical hub. Hubs serve to simplify USB connectivity from the user's perspective and provide robustness at low cost and complexity.

Hubs are wiring concentrators and enable the multiple attachment characteristics of USB. Attachment points are referred to as ports. Each hub converts a single attachment point into multiple attachment points. The architecture supports concatenation of multiple hubs.

The upstream port of a hub connects the hub towards the host. Each of the other downstream ports of a hub allows connection to another hub or function. Hubs can detect, attach and detach at each downstream port and enable the distribution of power to downstream devices. Each downstream port can be individually enabled and configured at either full or low speed. The hub isolates low speed ports from full speed

signaling.

A hub consists of two portions: the Hub Controller and Hub Repeater. The repeater is a protocol-controlled switch between the upstream port and downstream ports. It also has hardware support for reset and suspend/resume signaling. The controller provides the interface registers to allow communication to/from the host. Hub specific status and control commands permit the host to configure a hub and to monitor and control its ports.

### Device

A logical or physical entity that performs a function. The actual entity described depends on the context of the reference. At the lowest level, device may refer to a single hardware component, as in a memory device. At a higher level, it may refer to a collection of hardware components that perform a particular function, such as a Universal Serial Bus interface device. At an even higher level, device may refer to the function performed by an entity attached to the Universal Serial Bus; for example, a data/FAX modem device. Devices may be physical, electrical, addressable, and logical.

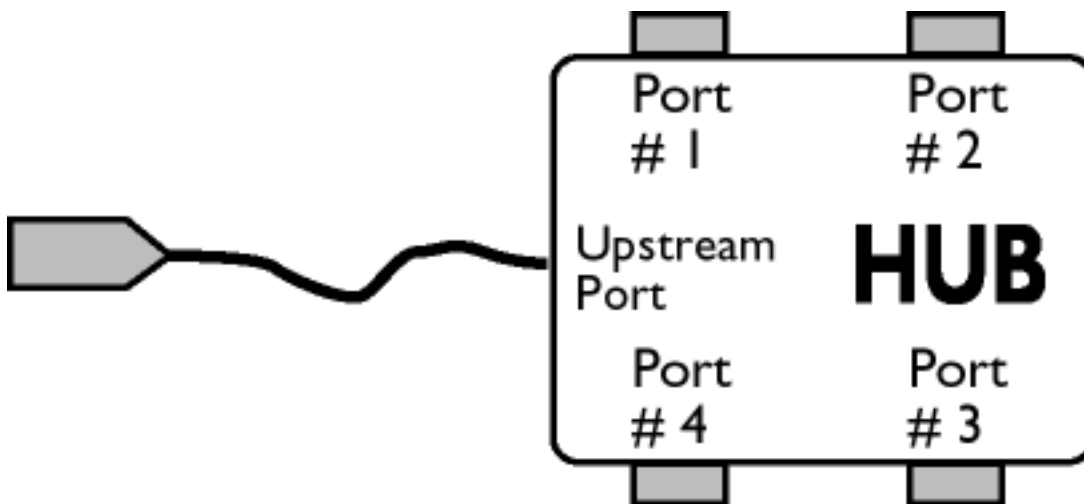

### Downstream

The direction of data flow from the host or away from the host. A downstream port is the port on a hub electrically farthest from the host that generates downstream data traffic from the hub. Downstream ports receive upstream data traffic.

### Upstream

The direction of data flow towards the host. An upstream port is the port on a device electrically closest to the host that generates upstream data traffic from the hub. Upstream ports receive downstream data traffic.

### UPS (Universal Power Supply)

The monitor with UPS feature can work in different countries with various mains voltage.

[RETURN TO TOP OF THE PAGE](#)



**V***Vertical dot pitch*

See Dot pitch.

*Vertical scanning frequency*

Expressed in Hz, this is the number of fields written to the screen every second in interlaced mode. In non-interlaced mode vertical scanning frequency is the number of frames (complete pictures) written to the screen every second (also known as refresh rate).

*Vertical sync pulses*

A train of square shaped waveforms that define the start of a new frame.

**VESA**

Video Electronic Standards Association, a consortium of manufacturers formed to establish and maintain industry-wide standards for video cards and monitors. VESA was instrumental in the introduction of the Super VGA and Extended VGA video graphics standards (see Video graphics adapters) with a refresh rate of 70 Hz, minimizing flicker and helping to reduce operator eyes fatigue and stress.

*Video dot rate*

See Dot rate.

*Video graphics adapters*

A card equipped with a character or graphic generator and video memory, which maps to the screen. A microprocessor scans video memory and translates bit information from the computer into displayable video signals for the monitor. These cards comply with various standards that determine the nature and quality of the display.

[VGA \(Video Graphics Array\)](#), introduced in 1987, was the first analog card. It offered still higher resolution than EGA: 640 X 480 pixels for graphics and 720 x 400 pixels for text, and a color palette of 256 colors. VGA could also emulate EGA and CGA.

[Super VGA](#), devised by VESA in 1989, offers a resolution of 800 x 600 pixels.

[Extended VGA](#), introduced by VESA in 1991, offers a top resolution of 1024 x 768 pixels (non-interlaced) and a refresh rate slightly higher than IBM's XGA 8514A.

[High-end, graphics adapters](#), introduced over the last three years for professional workstations, offer top

resolutions from 1280 x 1024 to 1600 x 1280, horizontal line frequencies up to 90 kHz and bandwidths up to 200 MHz.

### *VIS (Viewable Image Size)*

The real screen dimensions that users can see measured diagonally. The VIS of a monitor is always less than the so called screen size of a monitor. For example, the VIS of a 17-inch monitor is only about 16 inches. It depends on the useful screen size of CRT and the opening of a monitor's front cabinet.

[RETURN TO TOP OF THE PAGE](#)

# Download and Print

This page provides an option to read the manual in .pdf format. PDF files can be downloaded into your hard disk, then viewed and printed with Acrobat Reader or through your browser.

If you do not have Adobe® Acrobat Reader installed, click on the link to install the application. [Adobe® Acrobat Reader for PC](#) / [Adobe® Acrobat Reader for Mac](#).

## ***Download instructions:***







To download the file:

1. Click-and-hold your mouse over the icon below. (Win95/98 users right-click)
2. From the menu that appears, choose 'Save Link As...', 'Save Target As...' or 'Download Link to Disk'.
3. Choose where you would like to save the image; click 'Save' (if prompted to save as either 'text' or 'source', choose 'source').

## ***Printing instructions:***

To print the manual:

1. With the manual file open, follow your printer's instructions and print the pages you need.

- |  |                           |                         |
|--|---------------------------|-------------------------|
|  | <a href="#">104S.pdf</a>  | English language manual |
|  | <a href="#">105B.pdf</a>  |                         |
|  | <a href="#">105E.pdf</a>  |                         |
|  | <a href="#">105G.pdf</a>  |                         |
|  | <a href="#">105S.pdf</a>  |                         |
|  | <a href="#">107B.pdf</a>  |                         |
|  | <a href="#">107B3.pdf</a> |                         |
|  | <a href="#">107E.pdf</a>  |                         |



[107G.pdf](#)



[107P.pdf](#)



[107S.pdf](#)



[107T.pdf](#)



[109B.pdf](#)



[109P.pdf](#)



[109S.pdf](#)



[201B.pdf](#)



[201P.pdf](#)

**Safety and  
trouble shooting**

**About this  
manual**

**Product  
information**

**Installing your  
monitor**

**On-screen  
display**

**Customer care  
and warranty**

**FAQ**

**Glossary**

**Download  
& print**

**EXIT**

# Troubleshooting

[Safety Precautions and Maintenance](#) • [Troubleshooting](#) • [Regulatory Information](#)  
 • [Other Related Information](#)

## Common Problems

Having trouble? Something not working? Before calling for help, try these suggestions.

### Having this problem?

### Check these items

No Picture

(Power LED not lit)

- Make sure the Power cable is plugged into the power outlet and back of the monitor.
- Power button on top of the monitor should be in the ON position.
- Disconnect the monitor from the power outlet for about one minute.

No Picture

(Power LED is yellow)

- Make sure the computer is turned on.
- Make sure the monitor cable is properly connected to your computer.
- Check to see if the monitor cable has bent pins.
- The Energy Saving feature may be activated
- Make sure the Brightness and Contrast controls are set correctly.

No Picture

(Power LED is green)

- Make sure the monitor cable is properly connected to your computer.
- Check to see if the monitor cable has bent pins.
- Make sure the computer Power button is on.

Screen doesn't show

when you turn on the monitor

- Make sure the monitor cable is properly connected to your computer. (Also refer to the Quick Start Guide).
- Check to see if the monitor cable has bent pins.
- Make sure the computer is turned on.

No color or intermittent color

- If you are using a non-VESA-DDC standard video card, turn the DDC1 / 2B feature Off.

Color appears blotchy

- The picture may need degaussing.
- Remove any nearby magnetic objects.
- Face the monitor toward the East for the best picture quality.
- Check the Color Temperature.

Missing one or more colors

- Make sure the monitor cable is properly connected to your computer.
- Check to see if the monitor cable has bent pins.

Dim Picture

- Adjust the Brightness and Contrast controls.
- Check your video card and its owner's manual instructions for it may be a non-VESA-DDC Standard card.

Picture is too large or too small.

- Adjust the Horizontal and/or Vertical Size.
- Adjust the Zoom.

Edges of the picture are not square.

- Adjust the geometry.

Picture has a double image.

- Eliminate the use of a video extension cable and/or video switch box.
- Face the monitor toward the East for the best picture quality.

Picture is not sharp.

- Check to make sure Moiré is switched off.
- Adjust Sync Input.

Unstable Picture

- Increase your refresh rate.

Problem with On Screen Display

- Refer to the instructions and troubleshooting information in that chapter.

For further assistance, refer to the [Consumer Information Centers](#) list to contact your local Philips distributor.

[RETURN TO TOP OF THE PAGE](#)

# Regulatory Information

[TCO '99 Information](#) • [TCO Environmental Requirements](#) • [Energy Star Declaration](#) • [Federal Communications Commission \(FCC\) Notice \(U.S. Only\)](#) • [Commission Federale de la Communication \(FCC Declaration\)](#) • [EN 55022 Compliance \(Czech Republic Only\)](#) • [VCCI Class 2 Notice \(Japan Only\)](#) • [MIC Notice \(South Korea Only\)](#) • [Polish Center for Testing and Certification Notice](#) • [North Europe Information](#) • [BSMI Notice \(Taiwan Only\)](#) • [Ergonomie Hinweis \(nur Deutschland\)](#) • [Philips End-of-Life Disposal](#) • [Information for UK only](#)  
[Safety Precautions and Maintenance](#) • [Troubleshooting](#) • [Other Related Information](#)

## TCO '99 Information

• **TCO '99 : Available on 105S, 105B, 107S, 107B, 107P, 109S, 109B, 109P, 201B, and 201P.**



**Congratulations!** You have just purchased a TCO '99 approved and labeled product! Your choice has provided you with a product developed for professional use. Your purchase has also contributed to reducing the burden on the environment and also to the further development of environmentally adapted electronics products.

### *Why do we have environmentally labeled computers?*

In many countries, environmental labeling has become an established method for encouraging the adaptation of goods and services to the environment. The main problem, as far as computers and other electronics equipment are concerned, is that environmentally harmful substances are used both in the products and during their manufacture. Since it is not so far possible to satisfactorily recycle the majority of electronics equipment, most of these potentially damaging substances sooner or later enter nature.

There are also other characteristics of a computer, such as energy consumption levels, that are important from the viewpoints of both the work (internal) and natural (external) environments. Since all methods of electricity generation have a negative effect on the environment (e.g. acidic and climate-influencing emissions, radioactive waste), it is vital to save energy. Electronics equipment in offices is often left running continuously and thereby consumes a lot of energy.

### *What does labeling involve?*

This product meets the requirements for the TCO'99 scheme which provides for international and environmental labeling of personal computers. The labeling scheme was developed as a joint effort by the TCO (The Swedish Confederation of Professional Employees), Svenska Naturskyddsforeningen (The Swedish Society for Nature Conservation) and Statens Energimyndighet (The Swedish National Energy Administration).



Approval requirements cover a wide range of issues: environment, ergonomics, usability, emission of electric and magnetic fields, energy consumption and electrical and fire safety.

The environmental demands impose restrictions on the presence and use of heavy metals, brominated and chlorinated flame retardants, CFCs (freons) and chlorinated solvents, among other things. The product must be prepared for recycling and the manufacturer is obliged to have an environmental policy which must be adhered to in each country where the company implements its operational policy.

The energy requirements include a demand that the computer and/or display, after a certain period of inactivity, shall reduce its power consumption to a lower level in one or more stages. The length of time to reactivate the computer shall be reasonable for the user.

Labeled products must meet strict environmental demands, for example, in respect of the reduction of electric and magnetic fields, physical and visual ergonomics and good usability.

Below you will find a brief summary of the environmental requirements met by this product. The complete environmental criteria document may be ordered from:

TCO Development

SE-114 94 Stockholm, Sweden

Fax: +46 8 782 92 07

Email (Internet): [development@tco.se](mailto:development@tco.se)

*Current information regarding TCO'99 approved and labeled products may also be obtained via the Internet, using the address: <http://www.tco-info.com/>*

[RETURN TO TOP OF THE PAGE](#)

---

## Environmental Requirements

### *Flame retardants*

Flame retardants are present in printed circuit boards, cables, wires, casings and housings. Their purpose is to prevent, or at least to delay the spread of fire. Up to 30% of the plastic in a computer casing can consist of flame retardant substances. Most flame retardants contain bromine or chloride, and those flame retardants are chemically related to another group of environmental toxins, PCBs. Both the flame retardants containing bromine or chloride and the PCBs are suspected of giving rise to severe health effects, including reproductive damage in fish-eating birds and mammals, due to the bio-accumulative\* processes. Flame retardants have been found in human blood and researchers fear that disturbances in fetus development may occur.

The relevant TCO'99 demand requires that plastic components weighing more than 25 grams must not contain flame retardants with organically bound bromine or chlorine. Flame retardants are allowed in the printed circuit boards since no substitutes are available.

### **Cadmium\*\***

Cadmium is present in rechargeable batteries and in the color-generating layers of certain computer displays. Cadmium damages the nervous system and is toxic in high doses. The relevant TCO'99 requirement states that batteries, the color-generating layers of display screens and the electrical or

electronics components must not contain any cadmium.

## Mercury\*\*

Mercury is sometimes found in batteries, relays and switches. It damages the nervous system and is toxic in high doses. The relevant TCO'99 requirement states that batteries may not contain any mercury. It also demands that mercury is not present in any of the electrical or electronics components associated with the labeled unit.

## CFCs (freons)

The relevant TCO'99 requirement states that neither CFCs nor HCFCs may be used during the manufacture and assembly of the product. CFCs (freons) are sometimes used for washing printed circuit boards. CFCs break down ozone and thereby damage the ozone layer in the stratosphere, causing increased reception on earth of ultraviolet light with increased risks e.g. skin cancer (malignant melanoma) as a consequence.

## Lead\*\*

Lead can be found in picture tubes, display screens, solders and capacitors. Lead damages the nervous system and in higher doses, causes lead poisoning. The relevant TCO'99 requirement permits the inclusion of lead since no replacement has yet been developed.

**\* Bio-accumulative is defined as substances which accumulate within living organisms.**

**\*\* Lead, Cadmium and Mercury are heavy metals which are bio-accumulative.**

[RETURN TO TOP OF THE PAGE](#)

---

## Energy Star Declaration

### PHILIPS

### 107T2\*

This monitor is equipped with a function for saving energy which supports the VESA Display Power Management Signaling (DPMS) standard. This means that the monitor must be connected to a computer which supports VESA DPMS to fulfill the requirements in the NUTEK specification 803299/94. Time settings are adjusted from the system unit by software. From indicated inactivity to Power Saving Position A2, the total time must not be set to more than 70 minutes.

NUTEK	VESA State	LED Indicator	Power Consumption
Normal operation	ON	Green	< 73 W
Power Saving Position A1	Suspend	Yellow	< 3 W

Power Saving

OFF

Yellow

&lt; 3 W

Position A2



As an ENERGY STAR® Partner, PHILIPS has determined that this product meets the ENERGY STAR® guidelines for energy efficiency.



We recommend you switch off the monitor when it is not in use for quite a long time.

[RETURN TO TOP OF THE PAGE](#)

---

## Federal Communications Commission (FCC) Notice (U.S. Only)



This equipment has been tested and found to comply with the limits for a Class B digital device, pursuant to Part 15 of the FCC Rules. These limits are designed to provide reasonable protection against harmful interference in a residential installation. This equipment generates, uses and can radiate radio frequency energy and, if not installed and used in accordance with the instructions, may cause harmful interference to radio communications. However, there is no guarantee that interference will not occur in a particular installation. If this equipment does cause harmful interference to radio or television reception, which can be determined by turning the equipment off and on, the user is encouraged to try to correct the interference by one or more of the following measures:

- Reorient or relocate the receiving antenna.
- Increase the separation between the equipment and receiver.
- Connect the equipment into an outlet on a circuit different from that to which the receiver is connected.
- Consult the dealer or an experienced radio/TV technician for help.



Changes or modifications not expressly approved by the party responsible for compliance could void the user's authority to operate the equipment.

Use only RF shielded cable that was supplied with the monitor when connecting this monitor to a computer device.

To prevent damage which may result in fire or shock hazard, do not expose this appliance to rain or excessive moisture.

THIS CLASS B DIGITAL APPARATUS MEETS ALL REQUIREMENTS OF THE CANADIAN INTERFERENCE-CAUSING EQUIPMENT REGULATIONS.

[RETURN TO TOP OF THE PAGE](#)

---

## Commission Federale de la Communication (FCC Declaration)



Cet équipement a été testé et déclaré conforme aux limites des appareils numériques de class B, aux termes de l'article 15 Des règles de la FCC. Ces limites sont conçues de façon à fournir une protection raisonnable contre les interférences nuisibles dans le cadre d'une installation résidentielle. CET appareil produit, utilise et peut émettre des hyperfréquences qui, si l'appareil n'est pas installé et utilisé selon les consignes données, peuvent causer des interférences nuisibles aux communications radio. Cependant, rien ne peut garantir l'absence d'interférences dans le cadre d'une installation particulière. Si cet appareil est la cause d'interférences nuisibles pour la réception des signaux de radio ou de télévision, ce qui peut être décelé en fermant l'équipement, puis en le remettant en fonction, l'utilisateur pourrait essayer de corriger la situation en prenant les mesures suivantes:

- Réorienter ou déplacer l'antenne de réception.
- Augmenter la distance entre l'équipement et le récepteur.
- Brancher l'équipement sur un autre circuit que celui utilisé par le récepteur.
- Demander l'aide du marchand ou d'un technicien chevronné en radio/télévision.



Toutes modifications n'ayant pas reçu l'approbation des services compétents en matière de conformité est susceptible d'interdire à l'utilisateur l'usage du présent équipement.

N'utiliser que des câbles RF armés pour les connections avec des ordinateurs ou périphériques.

CET APPAREIL NUMERIQUE DE LA CLASSE B RESPECTE TOUTES LES EXIGENCES DU REGLEMENT SUR LE MATERIEL BROUILLEUR DU CANADA.

[RETURN TO TOP OF THE PAGE](#)

---

## EN 55022 Compliance (Czech Republic Only)

This device belongs to category B devices as described in EN 55022, unless it is specifically stated that it is a Class A device on the specification label. The following applies to devices in Class A of EN 55022 (radius of protection up to 30 meters). The user of the device is obliged to take all steps necessary to remove sources of interference to telecommunication or other devices.

Pokud není na typovém štítku počítače uvedeno, že spadá do do třídy A podle EN 55022, spadá automaticky do třídy B podle EN 55022. Pro zařízení zařazená do třídy A (chranné pásmo 30m) podle EN 55022 platí následující. Dojde-li k rušení telekomunikačních nebo jiných zařízení je uživatel povinen provést taková opatření, aby rušení odstranil.

[RETURN TO TOP OF THE PAGE](#)

---

## VCCI Notice (Japan Only)

This is a Class B product based on the standard of the Voluntary Control Council for Interference (VCCI) for Information technology equipment. If this equipment is used near a radio or television receiver in a domestic environment, it may cause radio Interference. Install and use the equipment according to the instruction manual.



Class B ITE

この装置は、情報処理装置等電波障害自主規制協議会 (VCCI) の基準に基づくクラス B 情報技術装置です。この装置は家庭環境で使用することを目的としていますが、この装置がラジオやテレビジョン受信機に近接して使用されると、受信障害を引き起こすことがあります。取扱説明書に従って正しい取り扱いをして下さい。

[RETURN TO TOP OF THE PAGE](#)

## MIC Notice (South Korea Only)

Class B Device

장치 종류	사용자 안내문
B급 기기	이 장치는 가정용으로 전자파 적합등록을 한 장치로서 주거지역에서는 물론 모든 지역에서 사용할 수 있습니다.



Please note that this device has been approved for non-business purposes and may be used in any environment, including residential areas.

[RETURN TO TOP OF THE PAGE](#)

## Polish Center for Testing and Certification Notice

The equipment should draw power from a socket with an attached protection circuit (a three-prong socket). All equipment that works together (computer, monitor, printer, and so on) should have the same power supply source.

The phasing conductor of the room's electrical installation should have a reserve short-circuit protection device in the form of a fuse with a nominal value no larger than 16 amperes (A).

To completely switch off the equipment, the power supply cable must be removed from the power supply socket, which should be located near the equipment and easily accessible.

A protection mark "B" confirms that the equipment is in compliance with the protection usage requirements of standards PN-93/T-42107 and PN-89/E-06251.

### ***Wymagania Polskiego Centrum Badań i Certyfikacji***

Urządzenie powinno być zasilane z gniazda z przyłączonym obwodem ochronnym (gniazdo z kolkiem). Współpracujące ze sobą urządzenia (komputer, monitor, drukarka) powinny być zasilane z tego samego źródła.

Instalacja elektryczna pomieszczenia powinna zawierać w przewodzie fazowym rezerwową ochronę przed zwarciami, w postaci bezpiecznika o wartości znamionowej nie większej niż 16A (amperów).

W celu całkowitego wyłączenia urządzenia z sieci zasilania, należy wyjąć wtyczkę kabla zasilającego z gniazda, które powinno znajdować się w pobliżu urządzenia i być łatwo dostępne.

Znak bezpieczeństwa "B" potwierdza zgodność urządzenia z wymaganiami bezpieczeństwa użytkowania zawartymi w PN-93/T-42107 i PN-89/E-06251.

### ***Pozostałe instrukcje bezpieczeństwa***

- Nie należy używać wtyczek adapterowych lub usuwać kolka obwodu ochronnego z wtyczki. Jeżeli konieczne jest użycie przedłużacza to należy użyć przedłużacza 3-żyłowego z prawidłowo połączonym przewodem ochronnym.
- System komputerowy należy zabezpieczyć przed nagłymi, chwilowymi wzrostami lub spadkami napięcia, używając eliminatora przepięć, urządzenia dopasowującego lub bezzakłóceniewego źródła zasilania.
- Należy upewnić się, aby nic nie leżało na kablach systemu komputerowego, oraz aby kable nie były umieszczone w miejscu, gdzie można byłoby na nie nadeptywać lub potykać się o nie.
- Nie należy rozlewać napojów ani innych płynów na system komputerowy.
- Nie należy wpychać żadnych przedmiotów do otworów systemu komputerowego, gdyż może to spowodować pożar lub porażenie prądem, poprzez zwarcie elementów wewnętrznych.
- System komputerowy powinien znajdować się z dala od grzejników i źródeł ciepła. Ponadto, nie należy blokować otworów wentylacyjnych. Należy unikać kładzenia luźnych papierów pod komputer oraz umieszczania komputera w ciasnym miejscu bez możliwości cyrkulacji powietrza wokół niego.

[RETURN TO TOP OF THE PAGE](#)

---

## North Europe Information

## Placering/Ventilation

### **VARNING:**

FÖRSÄKRA DIG OM ATT HUVUDBRYTARE OCH UTTAG ÄR LÄTÅTKOMLIGA, NÄR DU STÄLLER DIN UTRUSTNING PÅPLATS.

## Placering/Ventilation

### **ADVARSEL:**

SØRG VED PLACERINGSFOR, AT NETLEDNINGENS STIK OG STIKKONTAKT ER NEMT TILGÆNGELIGE.

## Paikka/Ilmankierto

### **VAROITUS:**

SIJOITA LAITE SITEN, ETTÄ VERKKOJOHTO VOIDAAN TARVITTAESSA HELPOSTI IRROTTAA PISTORASIESTA.

## Plassering/Ventilasjon

### **ADVARSEL:**

NÅR DETTE UTSTYRET PLASSERES, MÅ DU PASSE PÅ AT KONTAKTENE FOR STØMTILFØRSEL ER LETTE Å NÅ.

[RETURN TO TOP OF THE PAGE](#)

---

## **BSMI Notice (Taiwan Only)**

符合乙類資訊產品之標準

[RETURN TO TOP OF THE PAGE](#)

---



## Ergonomie Hinweis (nur Deutschland)

Der von uns gelieferte Farbmonitor entspricht den in der "Verordnung über den Schutz vor Schäden durch Röntgenstrahlen" festgelegten Vorschriften.

Auf der Rückwand des Gerätes befindet sich ein Aufkleber, der auf die Unbedenklichkeit der Inbetriebnahme hinweist, da die Vorschriften über die Bauart von Störstrahlern nach Anlage III  $\alpha$  5 Abs. 4 der Röntgenverordnung erfüllt sind.

Damit Ihr Monitor immer den in der Zulassung geforderten Werten entspricht, ist darauf zu achten, daß

1. Reparaturen nur durch Fachpersonal durchgeführt werden.
2. nur original-Ersatzteile verwendet werden.
3. bei Ersatz der Bildröhre nur eine bauartgleiche eingebaut wird.

Aus ergonomischen Gründen wird empfohlen, die Grundfarben Blau und Rot nicht auf dunklem Untergrund zu verwenden (schlechte Lesbarkeit und erhöhte Augenbelastung bei zu geringem Zeichenkontrast wären die Folge).

Der arbeitsplatzbezogene Schalldruckpegel nach DIN 45 635 beträgt 70dB (A) oder weniger.



**ACHTUNG: BEIM AUFSTELLEN DIESES GERÄTES DARAUFGAHTEN, DAß NETZSTECKER UND NETZKABELANSCHLUß LEICHT ZUGÄNGLICH SIND.**

[RETURN TO TOP OF THE PAGE](#)

---

## End-of-Life Disposal

Your new monitor contains materials that can be recycled and reused. Specialized companies can recycle your product to increase the amount of reusable materials and to minimize the amount to be disposed of.

Please find out about the local regulations on how to dispose of your old monitor from your local Philips dealer.

[RETURN TO TOP OF THE PAGE](#)

---

## Information for UK only

**WARNING - THIS APPLIANCE MUST BE EARTHED.**

**Important:**

This apparatus is supplied with an approved moulded 13A plug. To change a fuse in this type



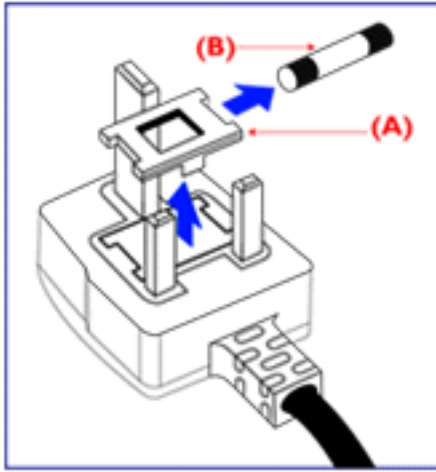

of plug proceed as follows:

1. Remove fuse cover and fuse.
2. Fit new fuse which should be a BS 1362 5A, A.S.T.A. or BSI approved type.
3. Refit the fuse cover.

If the fitted plug is not suitable for your socket outlets, it should be cut off and an appropriate 3-pin plug fitted in its place.

If the mains plug contains a fuse, this should have a value of 5A. If a plug without a fuse is used, the fuse at the distribution board should not be greater than 5A.

Note: The severed plug must be destroyed to avoid a possible shock hazard should it be inserted into a 13A socket elsewhere.

### How to connect a plug

The wires in the mains lead are coloured in accordance with the following code:

BLUE - "NEUTRAL" ("N")

BROWN - "LIVE" ("L")

GREEN & YELLOW - "EARTH" ("E")

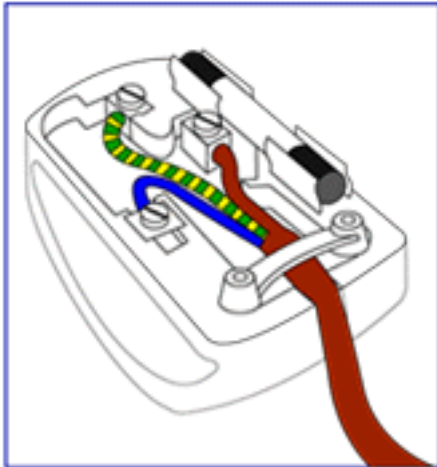

1. The GREEN AND YELLOW wire must be connected to the terminal in the plug which is marked with the letter "E" or by the Earth symbol  or coloured GREEN or GREEN AND YELLOW.

2. The BLUE wire must be connected to the terminal which is marked with the letter "N" or coloured BLACK.

3. The BROWN wire must be connected to the terminal which marked with the letter "L" or coloured RED.

Before replacing the plug cover, make certain that the cord grip is clamped over the sheath of

the lead - not simply over the three wires.

[RETURN TO TOP OF THE PAGE](#)

# Other Related Information

[Safety Precautions and Maintenance](#) • [Troubleshooting](#) • [Regulatory Information](#) • [Information for Users in the U. S.](#) • [Information for Users Outside the U.S](#)

---

## Information for Users in the U. S.

*For units set at 115 V :*

Use a UL Listed Cord Set consisting of a minimum 18 AWG, Type SVT or SJT three conductor cord a maximum of 15-feet long and a parallel blade, grounding type attachment plug rated 15 A, 125 V.

*For units set at 230 V:*

Use a UL Listed Cord Set consisting of a minimum 18 AWG, Type SVT or SJT three conductor cord a maximum of 15-feet long and a tandem blade, grounding type attachment plug rated 15 A, 250 V.

---

## Information for Users outside the U.S.

*For units set at 230 V:*

Use a Cord Set rated minimum 5 A, 250 V ( for units set at 230V ) or 10A, 125V (for units set at 115V). The Cord Set should have the appropriate safety approvals for the country in which the equipment will be installed.

[RETURN TO TOP OF THE PAGE](#)

# 6G3B11 Multimedia Base (option)

[Front View](#) • [Rear View](#) • [Technical Specifications](#) • [Description of the Controls](#) • [Installing your Multimedia Base](#) • [Power adapter Installation](#)

---

## Technical Specifications\*

- |                        |  |
|------------------------|--|
| • Output power         | 2 x 1.5W RMS / 36W PMPO                |
| • Bass Boost           |  |
| • Headphone connection | 3.5 mm jack                            |
| • Microphone in/out    | 3.5 mm jack                            |
| • Includes             | Audio cable and AC adapter             |
| • Dimension            | 9.4" x 2.1" x 8.2" / 239 x 54 x 208 mm |
| • Power consumption    | 5W                                     |

[RETURN TO TOP OF THE PAGE](#)

---

## Description of the Controls

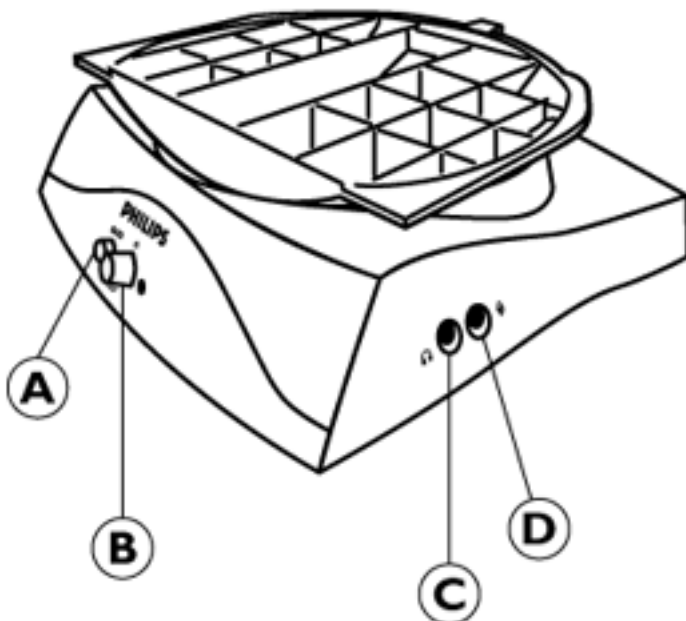

### A. Bass button

Turn on or off to enhance the Bass sound.

### B. Power knob / Volume knob

If the picture has wavy patterns when playing audio, reduce the volume. Turn clockwise to switch power on. Turning the knob more will increase the volume.

### C. Headphone jack

Attach your headphones here. The loudspeakers will automatically switch off once headphones are connected.

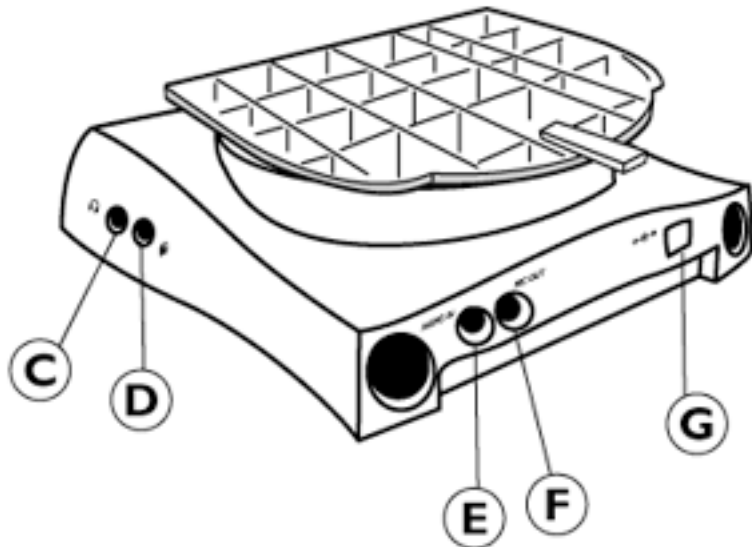

**D.** Microphone jack

Attach your microphone here.

**E.** Audio In

Connect this to the audio output of your PC.

**F.** MIC Out

Connect this to the microphone output of your PC.

**G.** DC Input

Connect power input here.

[RETURN TO TOP OF THE PAGE](#)

## Installing your Multimedia Pedestal



### 1. To INSTALL

- Slide the pedestal, aligning with the holes on the side.
- Then click the back hook into the corresponding hole on the bottom plate of your monitor.



## 2. To UN-INSTALL

- Lift the back hook from the hole on the bottom plate of your monitor.
- Slide out the pedestal the opposite direction (from when you installed it).

[RETURN TO TOP OF THE PAGE](#)

---

## Power adapter Installation

### Installing the adapter

There are two (2) ways of installing the adapter

- A. T-connector
- B. Wall more connector

- |   |                 |   |                |
|---|-----------------|---|----------------|
| 1 | Monitor         | 5 | T-connector    |
| 2 | Multimedia Base | 6 | PC power cord. |
| 3 | DC input        | 7 | Transformer    |
| 4 | PC              | 8 | Power outlet   |

#### Note:

Please keep 7 transformer away from 1 monitor as far as possible ( at least 50 cm ) to avoid cansing unstable monitor picture.

### A. For T-connector

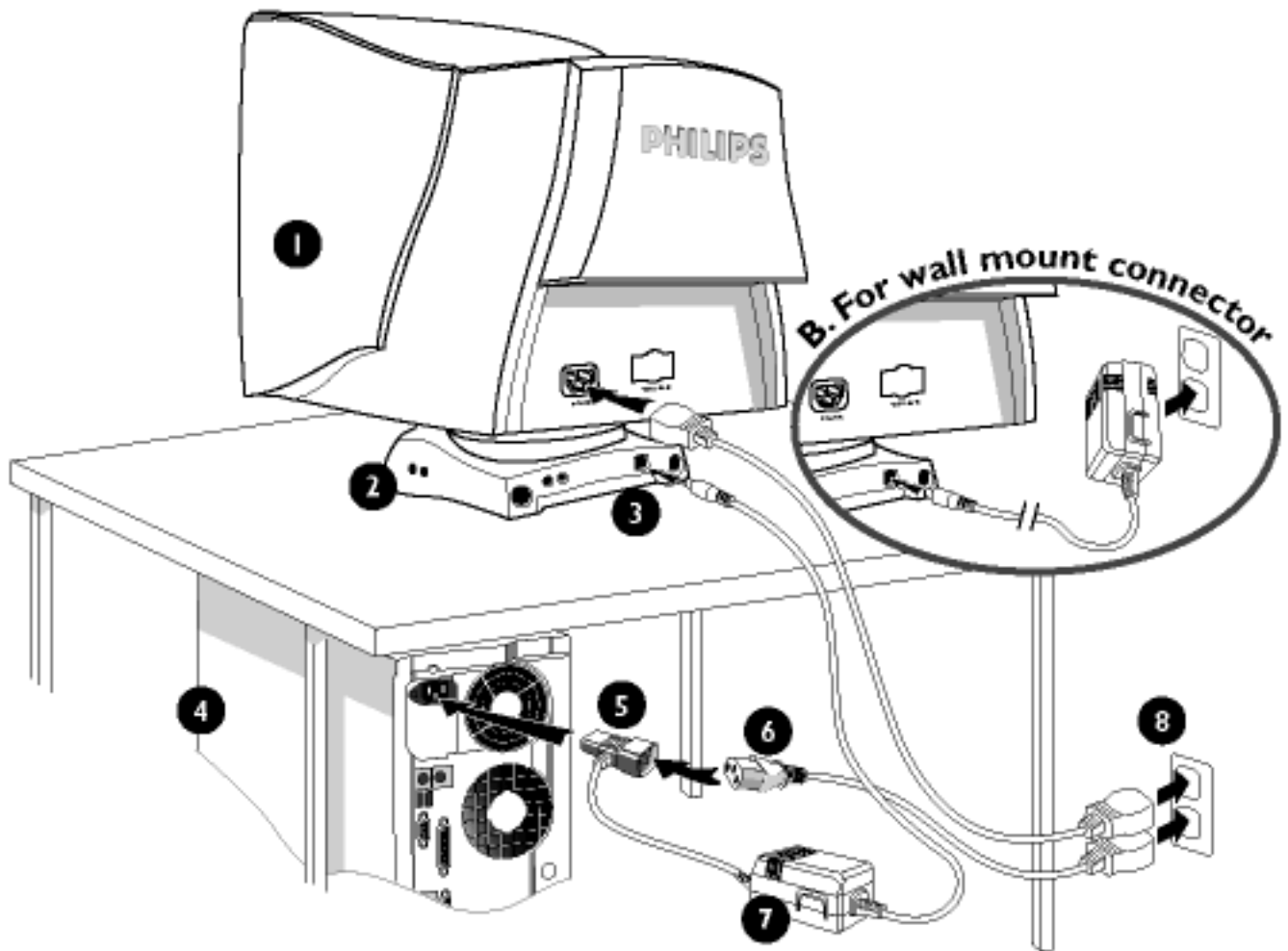

[RETURN TO TOP OF THE PAGE](#)

# PCUH411 USB Hub (Option)

[Front View](#) • [Rear View](#) • [Installing your USB Hub](#)

## Installing your USB Hub

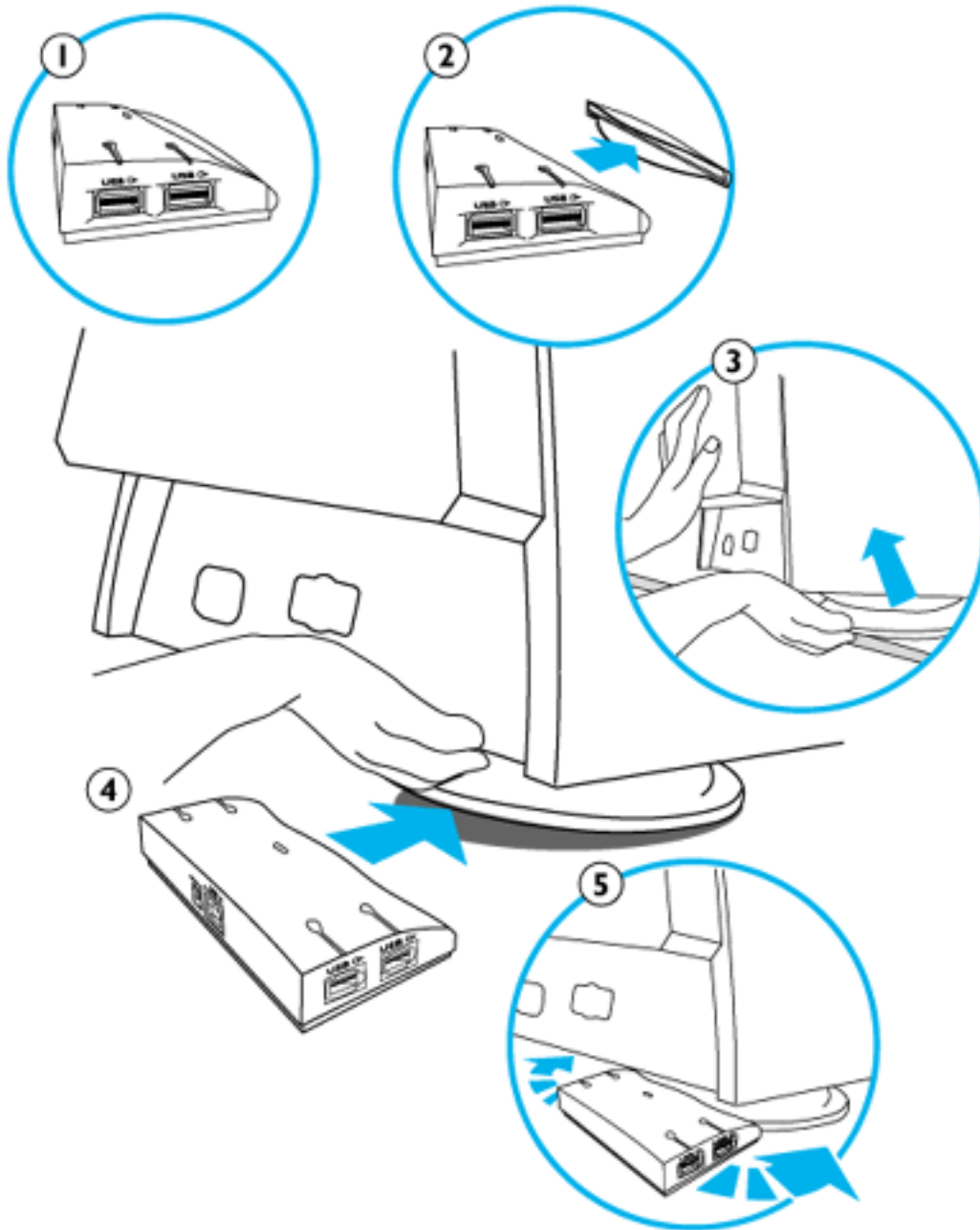

### Installing on a conventional base.

1. Take out the USB hub from the box.
2. Take off the USB hub cover.
3. Slightly tilt and lift the base of your monitor.
4. Attach the USB hub by clipping into the base.
5. You can reposition the USB hub along the base to suit your needs.

### Installing on the Multimedia base.

*Follow Steps 1 and 2 above.*

6. Position the USB



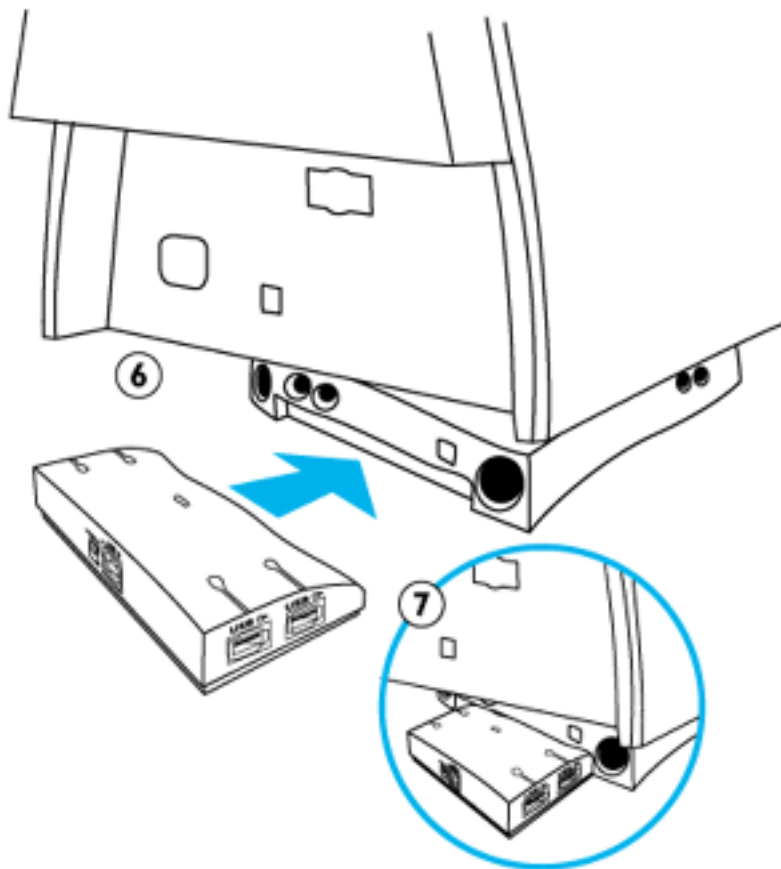

hub to the back of the Multimedia Pedestal.

7. Attach the USB hub by sliding-in to the Multimedia base.

[RETURN TO TOP OF THE PAGE](#)

# The OSD Controls

[Description of the On-Screen Display](#) • [The OSD Tree](#)

The OSD Controls : [Brightness \(HotKey\)](#) • [Contrast \(HotKey\)](#) • [Language](#) • [Input Signal Selection](#) • [Zoom](#) • [Adjust Horizontal](#) • [Adjust Vertical](#) • [Adjust Shape](#) • [Adjust Color](#) • [Reset to Factory Settings](#) • [Extra Controls](#) • [Close Main Controls](#)

---



## BRIGHTNESS

To adjust your screen's brightness, follow the steps below. Brightness is the overall intensity of the light coming from the screen. A 50% brightness is recommended.

1) Press the  or  button on the monitor. The BRIGHTNESS window appears.



2) Press the  or  button to adjust the brightness.

3) When the brightness is adjusted to the level desired, stop pressing the  or  button and after three seconds the BRIGHTNESS window will disappear with the new adjustment saved.



Smart

*After the BRIGHTNESS window has disappeared, to continue to the CONTRAST window, follow the steps under CONTRAST.*

Help

[RETURN TO TOP OF THE PAGE](#)

---



## CONTRAST

To adjust your screen's contrast, follow the steps bellow. Contrast is the difference between the light and dark areas on the screen. A 100% contrast is recommended.

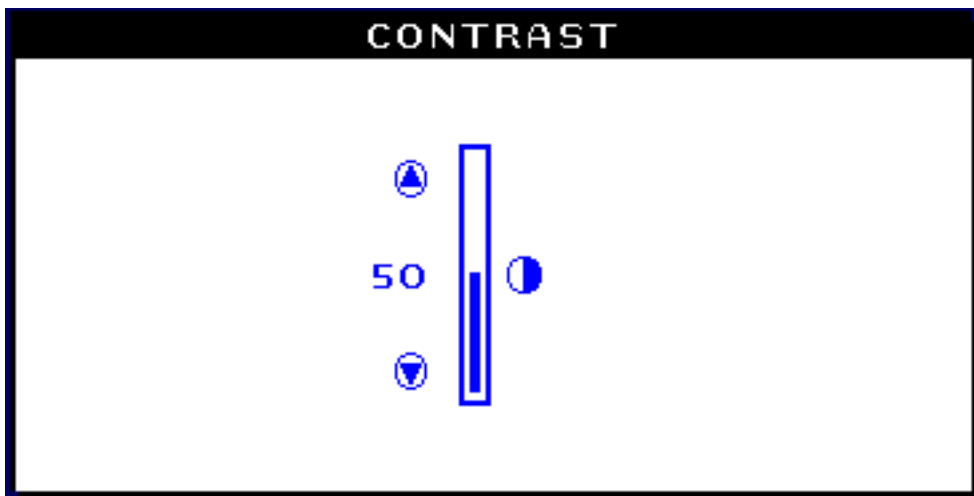
1) Press the  or  button on the monitor. The CONTRAST window appears.



2) Press the  or  button to adjust the contrast.

3) When the contrast is adjusted to the level desired, stop pressing the  or  button and after three seconds the CONTRAST window will disappear with the new adjustment saved.



Smart

Help

*After the CONTRAST window has disappeared, to continue to the MAIN CONTROLS, follow the steps under LANGUAGE*

[RETURN TO TOP OF THE PAGE](#)

---



## LANGUAGE

The ON SCREEN DISPLAY shows its settings in one of five languages. The default is English, but you can select French, Spanish, German, or Italian.

1) Press the  button on the monitor. The MAIN CONTROLS window appears. LANGUAGE should be highlighted.

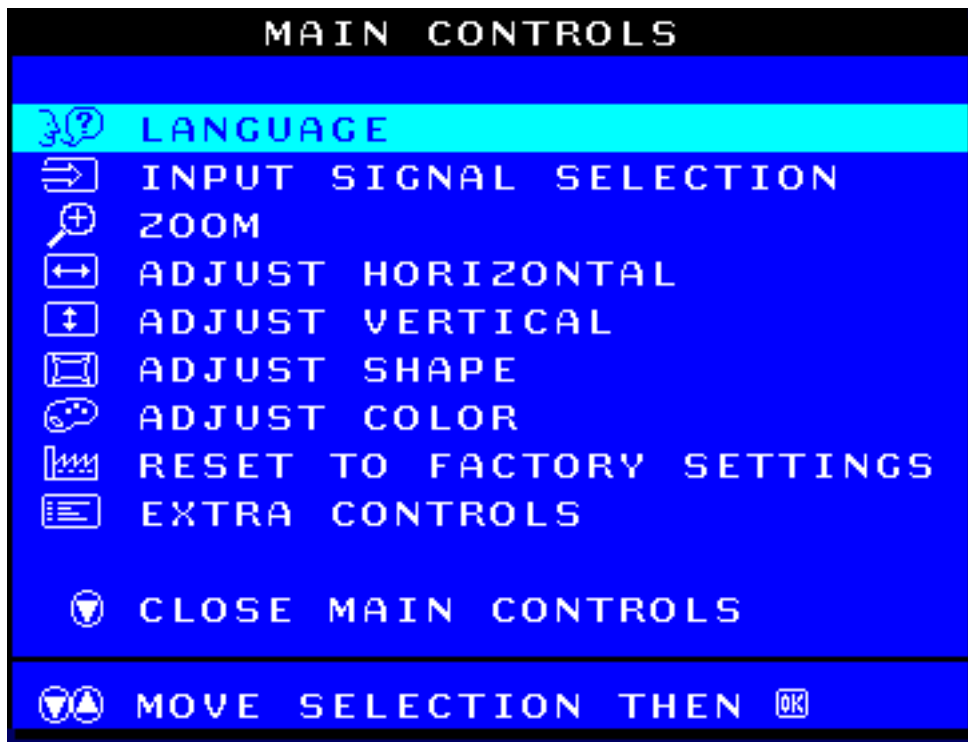
2) Press the  button again. The LANGUAGE window appears.



3) Press the  or  button until the desired language is highlighted.





4) Press the  button to confirm your selection and return to MAIN CONTROLS window. CLOSE MAIN CONTROLS will be highlighted...

*After returning to MAIN CONTROLS . . .*





**Smart  
Help**

*. . . to continue to INPUT SIGNAL SELECTION, press the  button until INPUT SIGNAL SELECTION is highlighted. Next, follow steps 3 - 5 under INPUT SIGNAL SELECTION.*

*. . . to exit completely, press the  button*

**INPUT SIGNAL SELECTION** *(Not available in all models)*



INPUT SIGNAL SELECTION determines what you see on the screen. The default setting is INPUT A, but if the video input signal is different than the output signal, you may want to change it to INPUT B.

- 1) Press the  button on the monitor. The MAIN CONTROLS window appears.
- 2) Press the  button until INPUT SIGNAL SELECTION is highlighted.

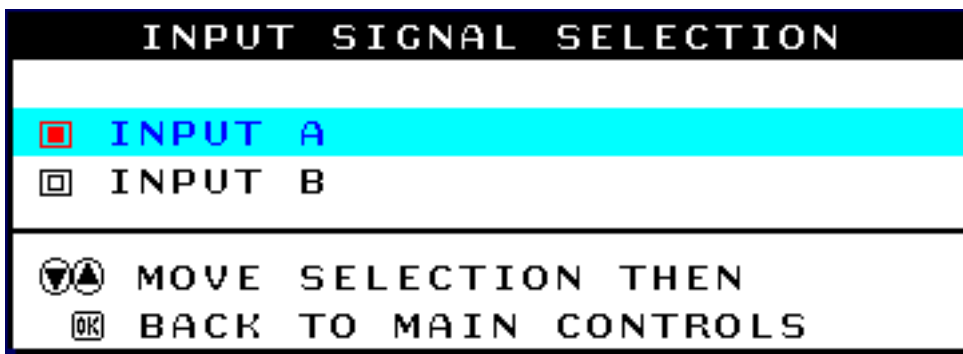

- 3) Press the  button. The INPUT SIGNAL SELECTION window appears.



- 4) Press the  or  button to highlight INPUT B or INPUT A.
- 5) Press the  button to confirm your selection and return to the MAIN CONTROLS window. CLOSE

MAIN CONTROLS will be highlighted.



Smart  
Help

After returning to MAIN CONTROLS . . .

. . . to continue to ZOOM, press the  button until ZOOM is highlighted. Next, follow steps 3 - 5 under ZOOM.



. . . to exit completely, press the  button

[RETURN TO TOP OF THE PAGE](#)

---

## ZOOM

ZOOM increases or decreases the size of the images on your screen. To adjust the ZOOM follow the steps below.

- 1) Press the  button on the monitor. The MAIN CONTROLS window appears.
- 2) Press the  button until ZOOM is highlighted.



- 3) Press the  button. The ZOOM window appears.

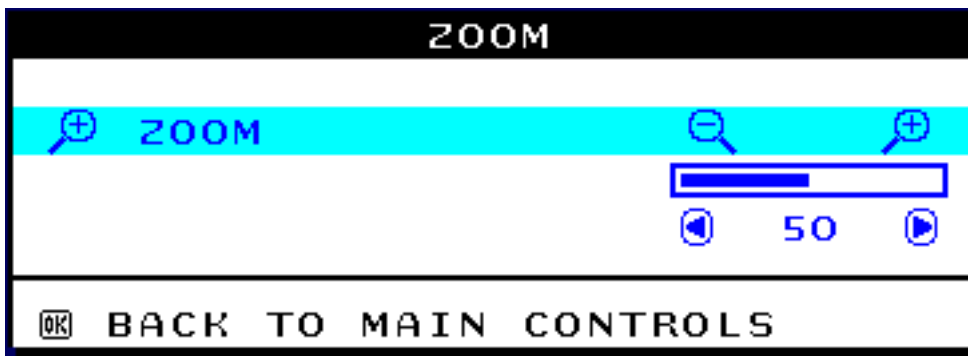

4) Press the  or  button to adjust ZOOM.

5) Press the  button to confirm your selection and return to the MAIN CONTROLS window. CLOSE MAIN CONTROLS will be highlighted.



Help

Smart

*After returning to MAIN CONTROLS . . .*

*. . . to continue to ADJUST HORIZONTAL, press the  button until ADJUST HORIZONTAL is highlighted. Next, follow steps 3 - 7 under ADJUST HORIZONTAL.*

*. . . to exit completely, press the  button*

[RETURN TO TOP OF THE PAGE](#)

---

## ADJUST HORIZONTAL

ADJUST POSITION under ADJUST HORIZONTAL shifts the image on your screen either to the left or right. Use this feature if your image does not appear centered. ADJUST SIZE under ADJUST HORIZONTAL expands or controls the image on your screen, pushing it out toward the left and right sides or pulling it in toward the center.



1) Press the  button on the monitor. The MAIN CONTROLS window appears.



2) Press the  button until ADJUST HORIZONTAL is highlighted.

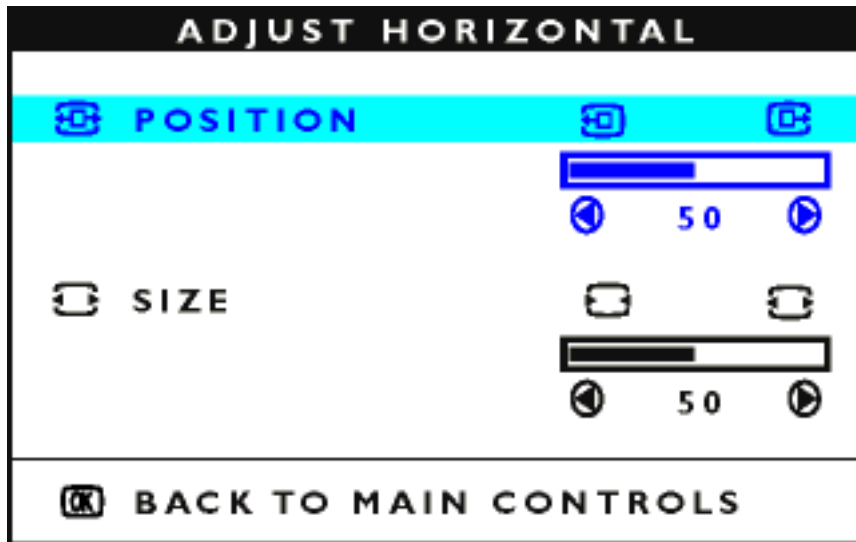

3) Press the  button. The ADJUST HORIZONTAL window appears. POSITION should be highlighted.





4) Press the  or  button to move the image to the left or right.

5) When the position is adjusted, press the  button to return to MAIN CONTROLS window, or press the  to highlight SIZE.

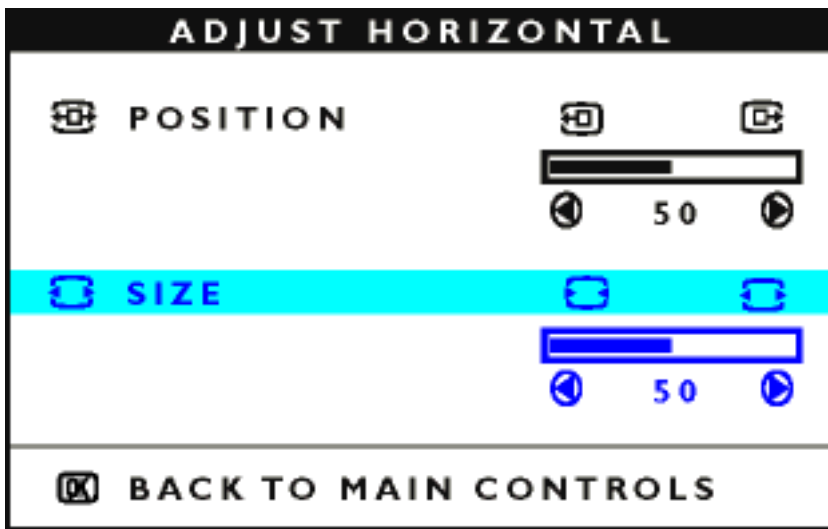



6) To adjust the horizontal size, press the  or  button.

7) When the size is adjusted, press the  button to return to MAIN CONTROLS window. CLOSE MAIN CONTROLS will be highlighted.

*After returning to MAIN CONTROLS . . .*



Help

Smart

*. . . to continue to ADJUST VERTICAL, press the  button until ADJUST VERTICAL is highlighted. Next, start with step 3 under ADJUST VERTICAL and follow the directions.*

*. . . to exit completely, press the  button*

[RETURN TO TOP OF THE PAGE](#)

## ADJUST VERTICAL

ADJUST POSITION under ADJUST VERTICAL shifts the image on your screen either up or down. Use this feature if your image does not appear centered. ADJUST SIZE under ADJUST VERTICAL expands or controls the image on your screen, pushing it out toward the top or bottom or pulling it in toward the center.



1) Press the  button on the monitor. The MAIN CONTROLS window appears.



2) Press the  button until ADJUST VERTICAL is highlighted.

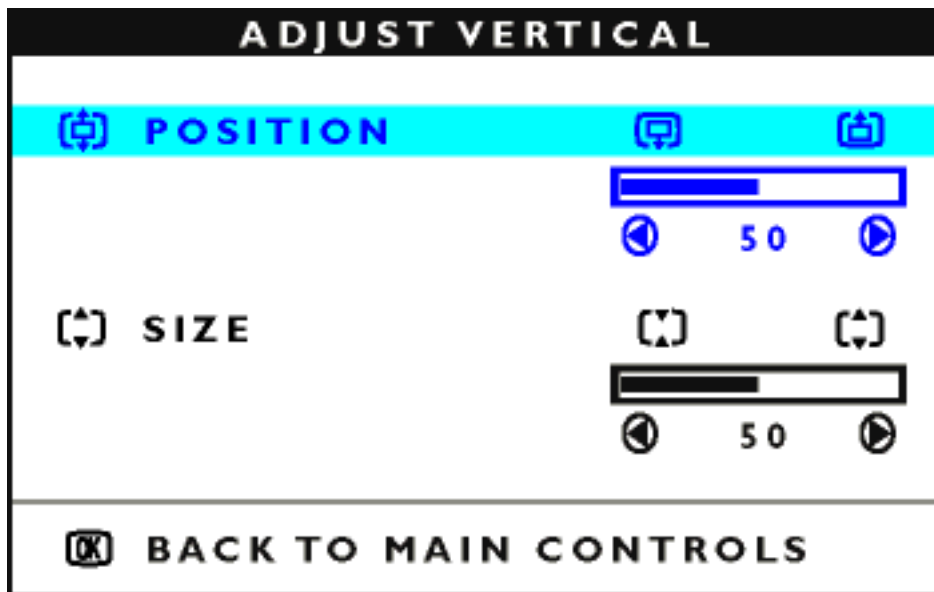



3) Press the  button. The ADJUST VERTICAL window appears. POSITION should be highlighted.

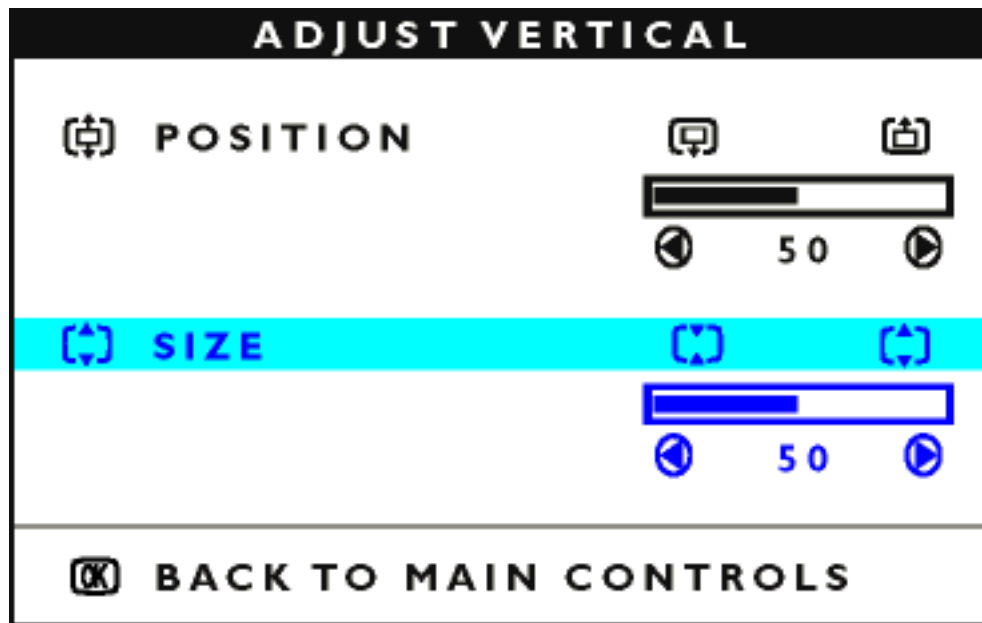

4) Press the  or  button to move the image up or down.

5) When the position is adjusted, press the  button to return to MAIN CONTROLS window, or press the  to highlight SIZE.



6) To adjust the vertical size, press the  or  button.

7) When the size is adjusted, press the  button to return to MAIN CONTROLS window. CLOSE MAIN CONTROLS will be highlighted.

*After returning to MAIN CONTROLS . . .*



Help

Smart

*. . . to continue to ADJUST SHAPE, press the  button until ADJUST SHAPE is highlighted. Next, start with step 3 under ADJUST SHAPE and follow the directions.*

*. . . to exit completely, press the  button*

[RETURN TO TOP OF THE PAGE](#)

## ADJUST SHAPE

### ADJUST SIDE CURVE

ADJUST SIDE CURVE under ADJUST SHAPE allows you to adjust two of the five preset options. These two options are PINCUSHION and BALANCED pincushion. Note: use these features only when the picture is not square.

1) Press the  button on the monitor. The MAIN CONTROLS window appears.

2) Press the  button until ADJUST SHAPE is highlighted.

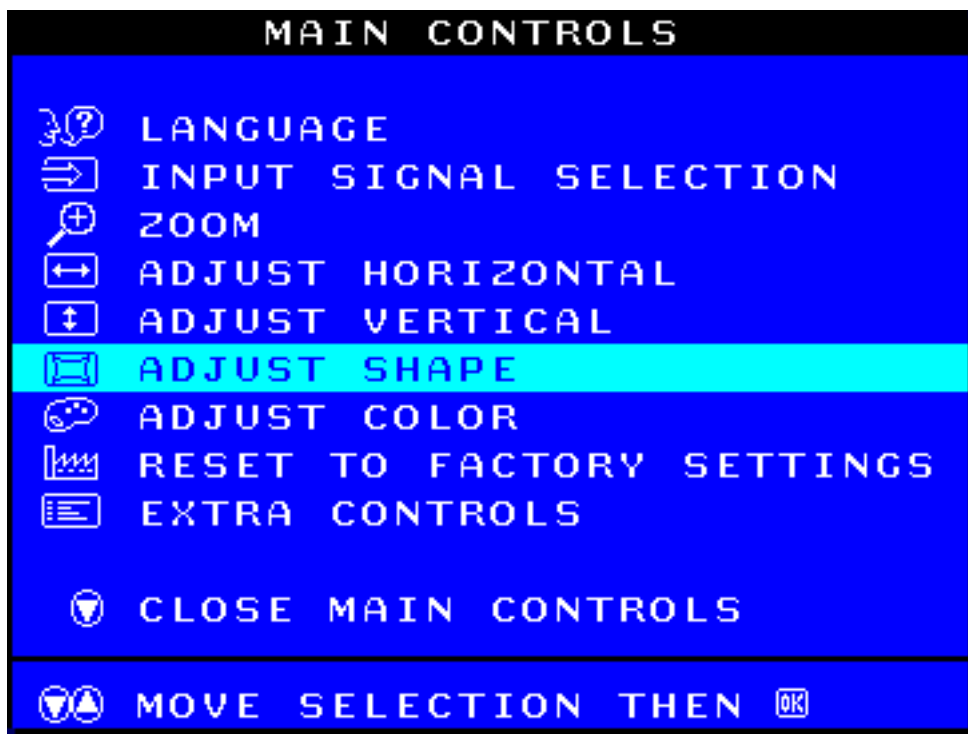

3) Press the  button. The ADJUST SHAPE window appears. ADJUST SIDE CURVE should be highlighted.

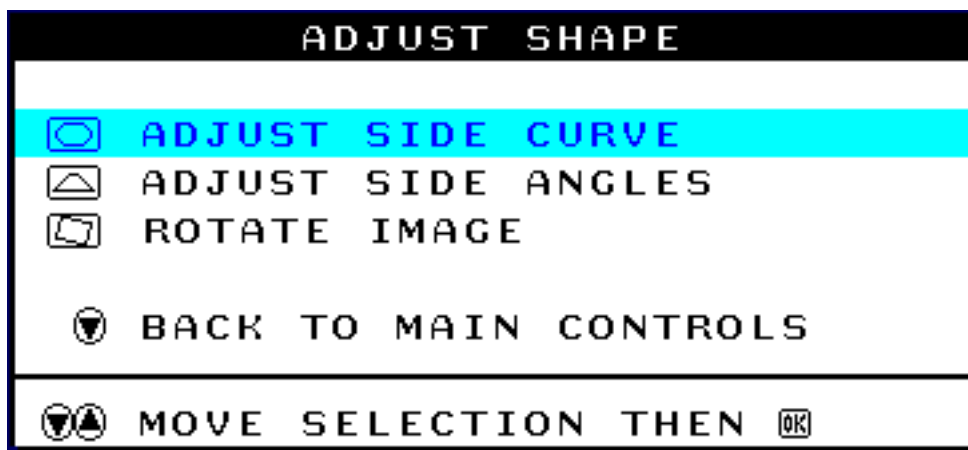

4) Press the  button. The SIDE CURVE window appears. PINCUSHION should be highlighted.

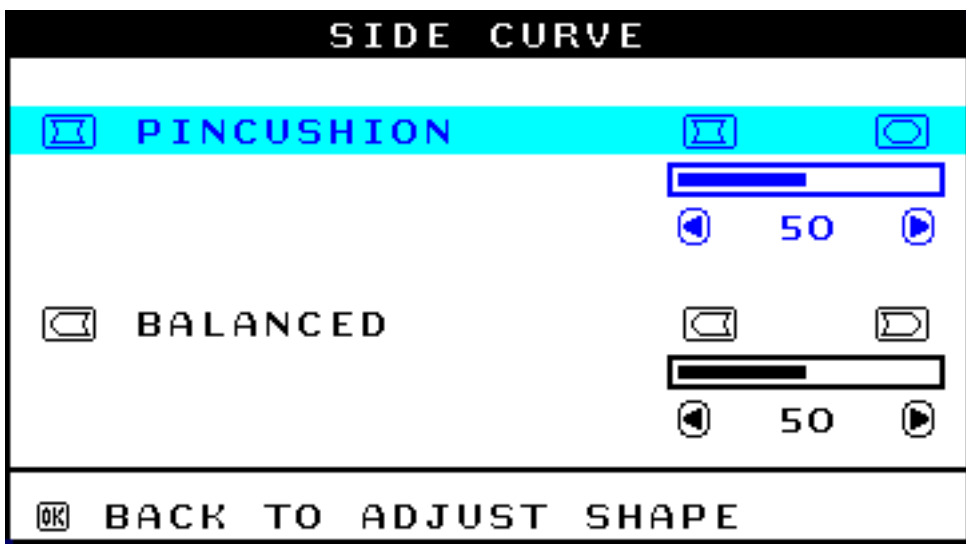

5) To adjust the pincushion, press the ◀ or ▶ button.

6) When the pincushion is adjusted, press the ▼ button to highlight BALANCED or press the OK button to return to the ADJUST SHAPE window.

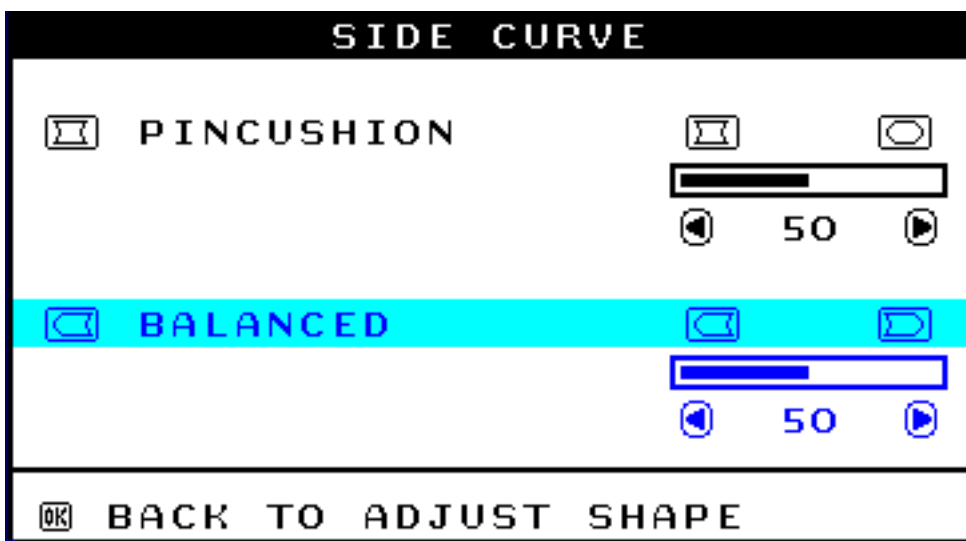

7) To adjust the balanced pincushion, press the ◀ or ▶ button.

8) When the balanced pincushion is adjusted, press the OK button to return to the ADJUST SHAPE window. BACK TO MAIN WINDOWS will be highlighted.

9) Press the OK button to return to the MAIN CONTROLS window, or press the ▲ button until ADJUST SIDE ANGLES is highlighted.

After returning to MAIN CONTROLS . . .



**Smart  
Help**



...to continue to ADJUST SIDE ANGLES, start with step 5 under ADJUST SIDE ANGLES and follow the directions.

...to exit completely, press the  button twice.

...to adjust only the BALANCED pincushion, follow steps 1 - 4 above, then press the  button, and follow steps 7 - 9.

## ADJUST SIDE ANGLES

ADJUST SIDE ANGLES under ADJUST SHAPE allows you to adjust two of the five preset options. These two options are TRAPEZOID and PARALLELOGRAM. Note: use these features only when the picture is not square.

- 1) Press the  button on the monitor. The MAIN CONTROLS window appears.
- 2) Press the  button until ADJUST SHAPE is highlighted.

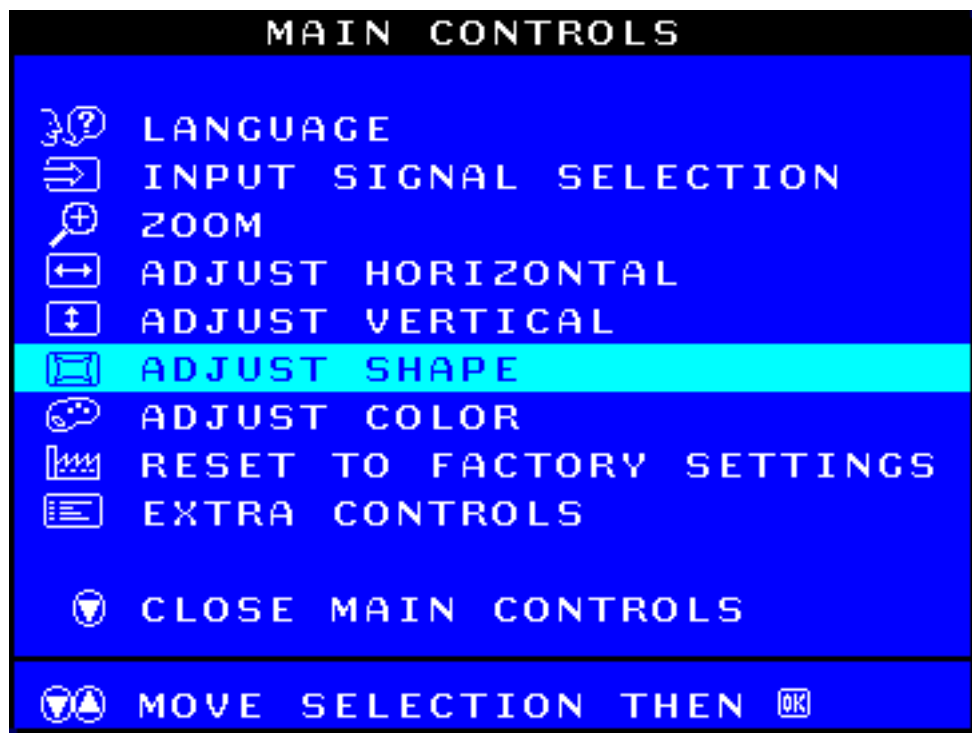

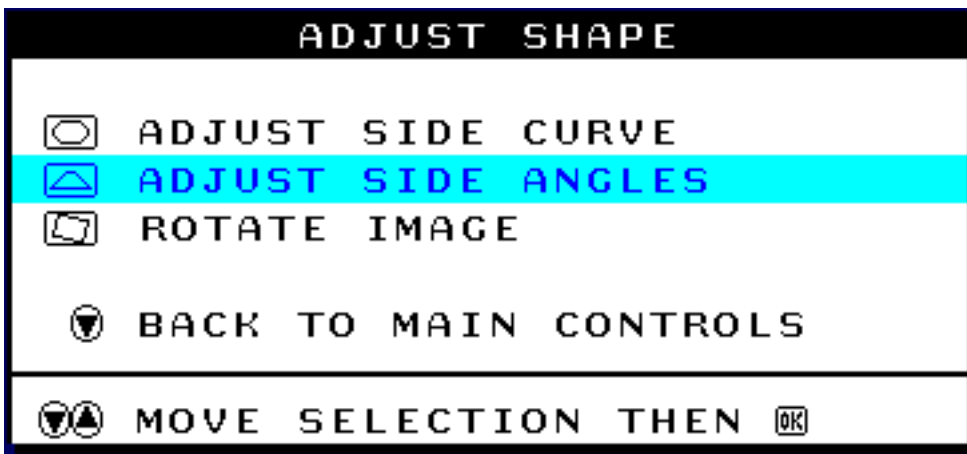

- 3) Press the  button. The ADJUST SHAPE window appears. ADJUST SIDE CURVE should be highlighted.



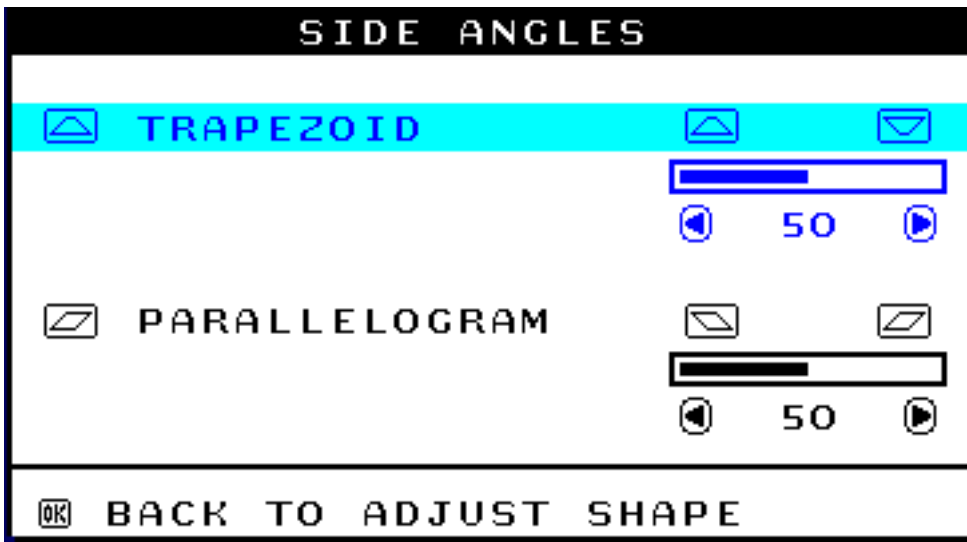

4) Press the  button to highlight ADJUST SIDE ANGLES.

5) Press the  button. The SIDE ANGLES window appears. TRAPEZOID should be highlighted.



6) To adjust the trapezoid, press the  or  button.

7) When the trapezoid is adjusted, press the  button to highlight PARALLELOGRAM or press the  button to return to the ADJUST SHAPE window.

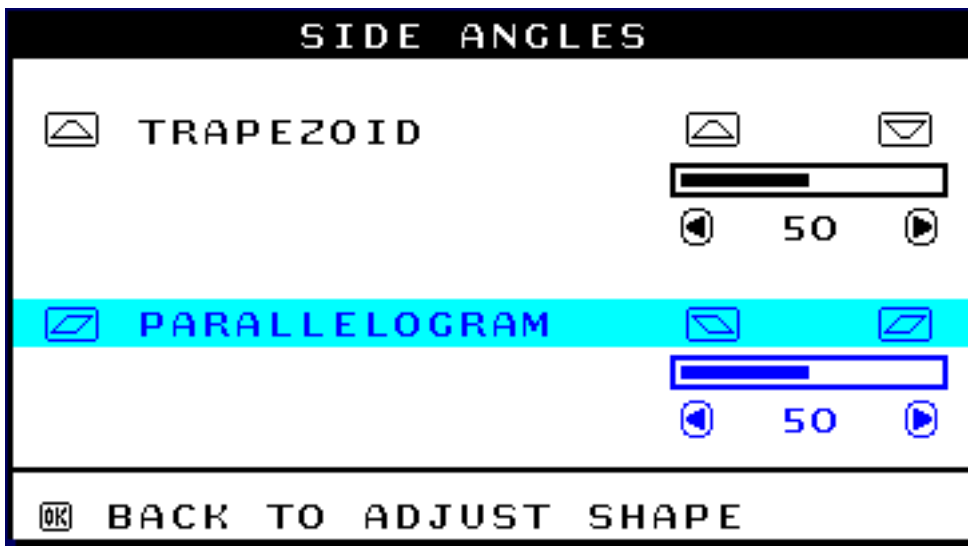

8) To adjust the parallelogram, press the or button.

9) When the parallelogram is adjusted, press the button to return to the ADJUST SHAPE window. BACK TO MAIN WINDOWS will be highlighted.

10) Press the button to return to the MAIN CONTROLS window, or press the button until ROTATE IMAGE is highlighted.

*After returning to MAIN CONTROLS . . .*



**Smart**

**Help**

*...to continue to ROTATE IMAGE, start with step 5 under ROTATE IMAGE and follow the directions.*

*...to exit completely, press the button twice.*

*...to adjust only the PARALLELOGRAM, follow steps 1 - 4 above, then press the button, and follow steps 7 - 9.*

### **ROTATE IMAGE (Not available in all models)**

ROTATE IMAGE under ADJUST SHAPE allows you to adjust one of the five preset options. These two options are PINCUSHION and BALANCED pincushion. Note: use this feature only when the picture is not square.

1) Press the button on the monitor. The MAIN CONTROLS window appears.

2) Press the button until ADJUST SHAPE is highlighted.



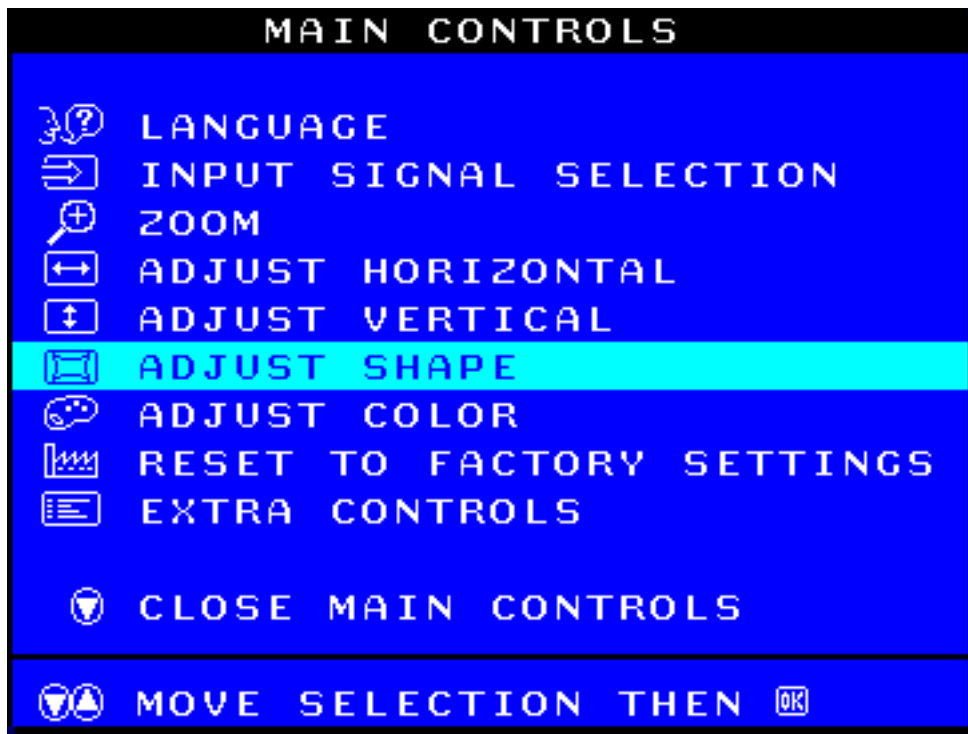

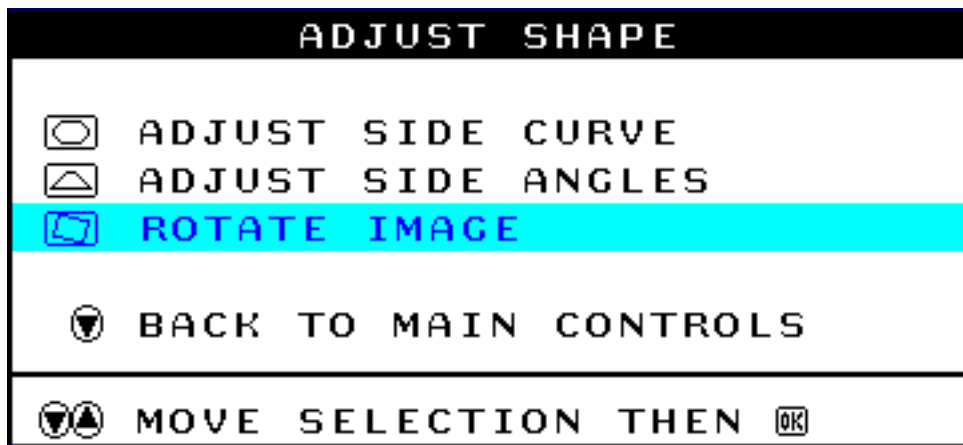

3) Press the  button. The ADJUST SHAPE window appears. ADJUST SIDE CURVE should be highlighted.

4) Press the  arrow until ROTATE IMAGE is highlighted.

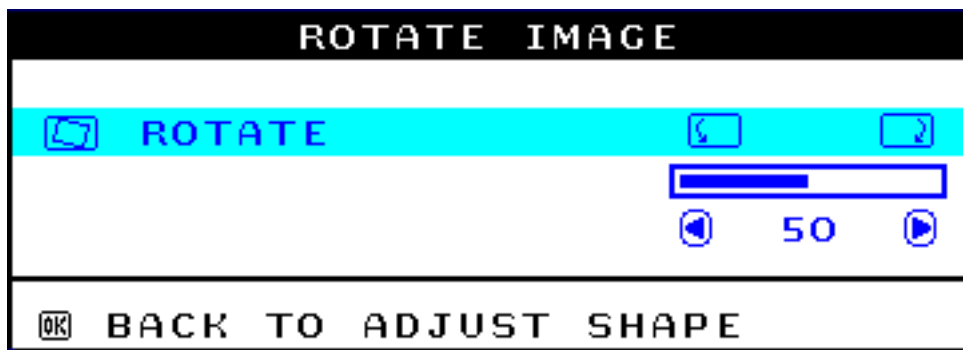

5) Press the  button. The ROTATE IMAGE window appears. ROTATE should be highlighted.



6) To adjust the rotation, press the  or  button.

7) When the rotation is adjusted, press the  button to return to the ADJUST SHAPE window. BACK TO MAIN CONTROLS should be highlighted.

8) Press the  button to return to MAIN CONTROLS.

*After returning to MAIN CONTROLS . . .*



Help

Smart

*. . . to continue to ADJUST COLOR, press the  button until ADJUST COLOR is highlighted. Next, start with step 3 under ADJUST COLOR and follow the directions.*

*...to exit completely, press the  button twice.*

[RETURN TO TOP OF THE PAGE](#)

---

## ADJUST COLOR

Your monitor has three preset options you can choose from. The first option is for GENERAL USE, which is fine for most applications. The second option is for IMAGE MANAGEMENT, which includes projects such as desktop publishing, viewing a DVD from your DVD player or pictures on the World Wide Web, and playing video games. The third option is for PHOTO RETOUCH, which is for working with pictures you have imported into your computer and want to alter. When you select one of these options, the monitor automatically adjusts itself to that option. There is also a fourth option, USER PRESET, which allows you to adjust the colors on your screen to a setting you desire.



1) Press the  button on the monitor. The MAIN CONTROLS window appears.

2) Press the  button until ADJUST COLOR is highlighted.

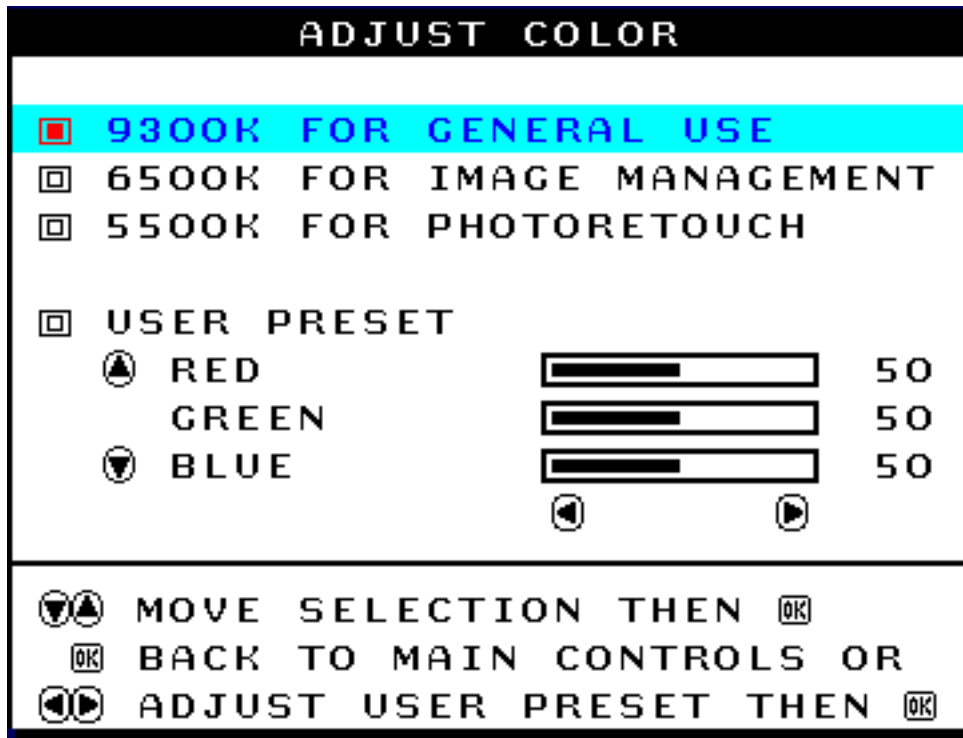

3) Press the  button. The ADJUST COLOR window appears.



4) Press the  or  button to highlight 9300K for GENERAL USE, 6500K for IMAGE MANAGEMENT, 5500K for PHOTO RETOUCH, or USER PRESET.

5) Once you have highlighted GENERAL USE, IMAGE MANAGEMENT, or PHOTO RETOUCH, press the  button to confirm your selection and return to the MAIN CONTROLS window. CLOSE MAIN CONTROLS will be highlighted.

## ADJUST COLOR

- 9300K FOR GENERAL USE
- 6500K FOR IMAGE MANAGEMENT
- 5500K FOR PHOTORETOUCH

### USER PRESET

▲	RED	<input style="width: 100%;" type="text" value="50"/>	50
	GREEN	<input style="width: 100%;" type="text" value="50"/>	50
▼	BLUE	<input style="width: 100%;" type="text" value="50"/>	50
		◀ ▶	

- ▼▲ MOVE SELECTION THEN OK
- OK BACK TO MAIN CONTROLS OR
- ◀▶ ADJUST USER PRESET THEN OK

6a) If USER PRESET is highlighted, press the ▼ button to highlight RED. Next, press the ◀ or ▶ button to adjust the color red.

6b) When finished with RED, press the ▼ button to highlight GREEN. Next, press the ◀ or ▶ button to adjust the color green.

6c) When finished GREEN, press the ▼ button to highlight BLUE. Next, press the ◀ or ▶ button to adjust the color blue.

6d) When all adjustments are complete, press the OK button to confirm your adjustments and return to the MAIN CONTROLS window. CLOSE MAIN CONTROLS will be highlighted.



*After returning to MAIN CONTROLS. . .*

**Help**



**Smart** . . . to continue to RESET TO FACTORY SETTINGS, press the ▲ button until RESET TO FACTORY SETTINGS is highlighted. Next, start with step 3 under RESET TO FACTORY SETTINGS.

. . . to exit completely, press the OK button.



[RETURN TO TOP OF THE PAGE](#)

## RESET TO FACTORY SETTINGS

RESET TO FACTORY SETTINGS returns everything in all the windows to factory presets.

- 1) Press the  button on the monitor. The MAIN CONTROLS window appears.
- 2) Press the  button until RESET TO FACTORY SETTINGS is highlighted.



- 3) Press the  button. The RESET TO FACTORY SETTINGS window appears.
- 4) Press the  or  button to select YES or NO. NO is the default. YES returns all settings to their original factory adjustments.

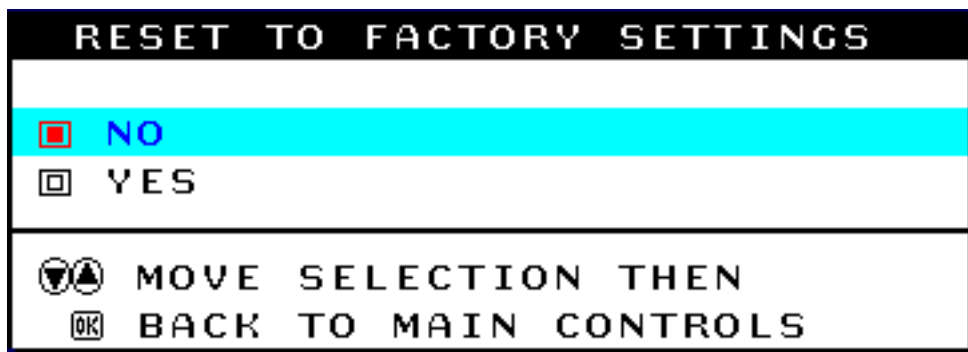

- 5) Press the  button to confirm your selection and return to the MAIN CONTROLS window. CLOSE MAIN CONTROLS will be highlighted.



Help

Smart

After returning to MAIN CONTROLS . . .

. . . to continue to EXTRA CONTROLS, press the  button until EXTRA CONTROLS is highlighted. Next, start with step 3 under EXTRA CONTROLS.



. . . to exit completely, press the  button.

[RETURN TO TOP OF THE PAGE](#)



## EXTRA CONTROLS

### DEGAUSS

EXTRA CONTROLS is a set of three features, including DEGAUSS. Degaussing removes electromagnetic build up that may distort the color on your screen.

- 1) Press the  button on the monitor. The MAIN CONTROLS window appears.
- 2) Press the  button until EXTRA CONTROLS is highlighted.



- 3) Press the  button. The EXTRA CONTROLS window appears. MOIRE will be highlighted.
- 4) Press the  button to highlight DEGAUSS.

## EXTRA CONTROLS

 ADJUST MOIRÉ

 **DEGAUSS**

 LIGHTFRAME     OFF    ON 

 BACK TO MAIN CONTROLS

  MOVE SELECTION THEN 

SERIAL NUMBER TY 123456

RESOLUTION 1600/1200, 1280/1024

FREQUENCY 107K/85HZ, 64K/60HZ

5) To degauss your screen, press the  button. Your screen will be degaussed, then the MAIN CONTROLS window will reappear. CLOSE MAIN CONTROLS will be highlighted.

*After returning to MAIN CONTROLS . . .*



Help

Smart

*. . . to continue to ADJUST MOIRE, press the  button until EXTRA CONTROLS is highlighted. Next, start with step 3 under EXTRA CONTROLS, ADJUST MOIRE.*

*. . . to exit completely, press the  button.*

### **ADJUST MOIRE (Not available in all models)**

EXTRA CONTROLS is a set of three features, including ADJUST MOIRE. Moire is a fringe pattern arising from the interference between two superimposed line patterns. To adjust your moire, follow the steps below. Note: Use only if necessary. By activating ADJUST MOIRE, sharpness can be affected.

1) Press the  button on the monitor. The MAIN CONTROLS window appears.

2) Press the DOWN CURSOR button until EXTRA CONTROLS is highlighted.



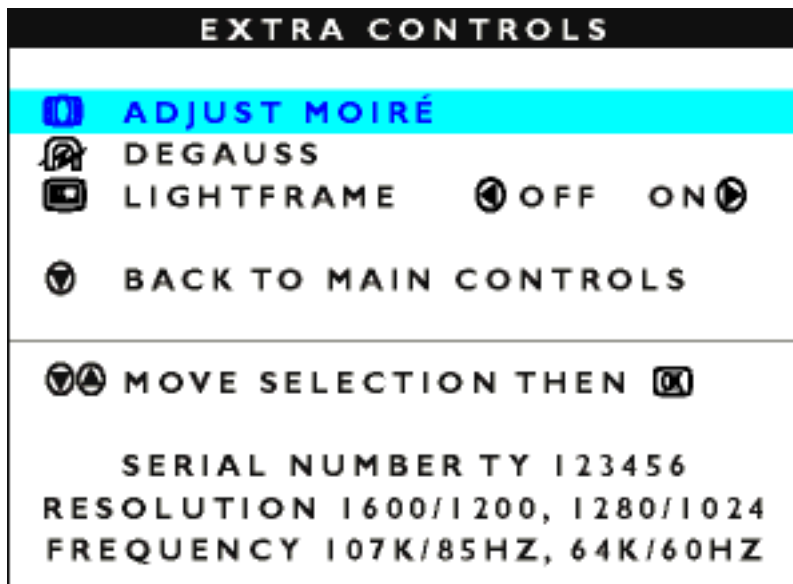

3) Press the  button. The EXTRA CONTROLS window appears. ADJUST MOIRE will be highlighted.



4) Press the  button. The ADJUST MOIRE window appears. HORIZONTAL will be highlighted.

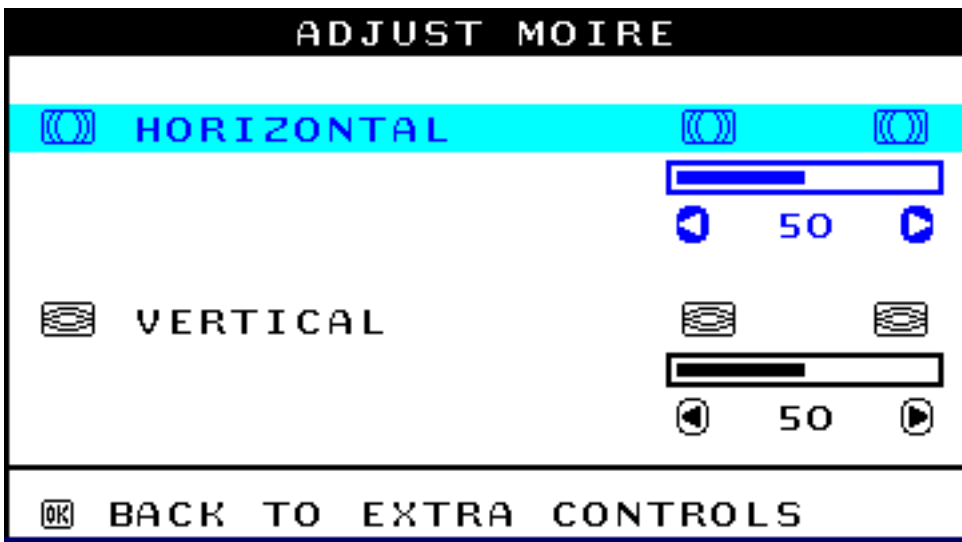



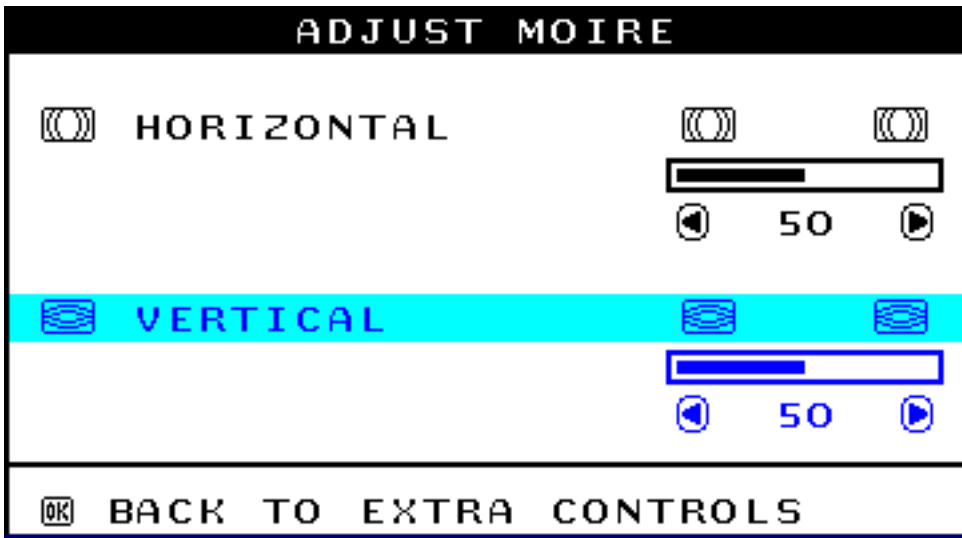

5) To adjust the horizontal moire, press the  or  button.

6) When the horizontal moire is adjusted, press the  button to highlight VERTICAL.



7) To adjust the vertical moire, press the  or  button.

8) When the vertical moire is adjusted, press the  button to return to the EXTRA CONTROLS window. BACK TO MAIN CONTROLS will be highlighted.



*After returning to MAIN CONTROLS . . .*



**Smart**  
**Help**

*. . . to exit completely, press the  button.*



### ***Turn on LightFrame (Not available in all models)***

EXTRA CONTROLS is a set of three features, including LIGHTFRAME. This feature allows the user to turn





on the LIGHTFRAME function to activate in full screen mode.

- 1) Press  button on the monitor. The MAIN CONTROLS window appears.
- 2) Press the  button until EXTRA CONTROLS is highlight.

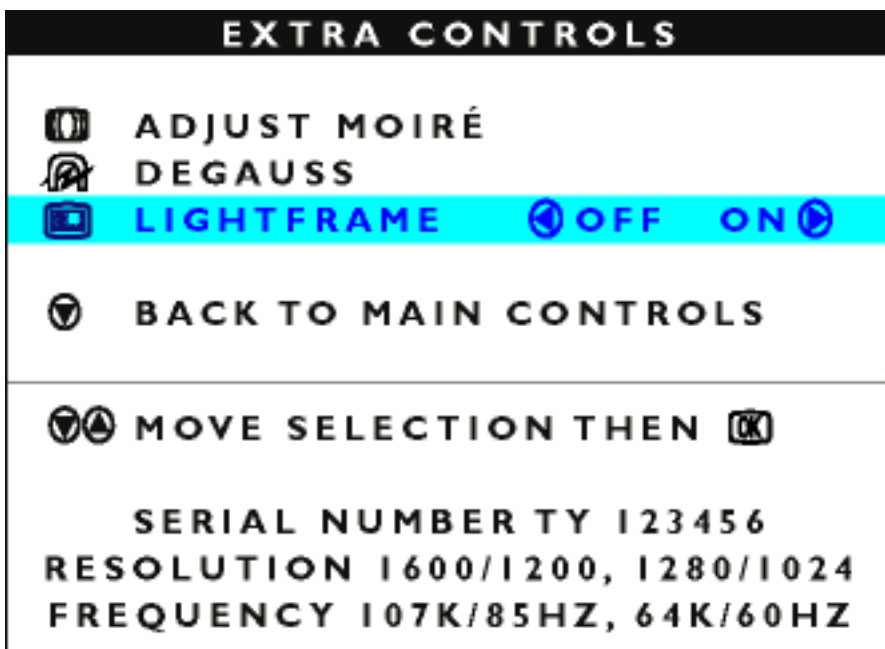

- 3) Press the  button. The EXTRA CONTROLS window appears. ADJUST MOIRE will be highlighted.
- 4) Press the  button until LIGHTFRAME is highlighted.



- 5) Press the  button. LIGHTFRAME will be activated.
- 6) Press the  button to highlight BACK TO MAIN CONTROLS. Press  button to go back to MAIN CONTROLS. Press  button again to exit the OSD.

[RETURN TO TOP OF THE PAGE](#)

---

## CLOSE MAIN CONTROLS



[RETURN TO TOP OF THE PAGE](#)

## Your International Philips F1rst Choice Warranty

Thank you for purchasing this Philips monitor.



All Philips monitors are designed and manufactured to high standards and deliver high-quality performance, ease of use and ease of installation. Should you encounter any difficulties while installing or using this product, please contact Philips directly to benefit from your Philips F1rst Choice Warranty. This three-year service warranty entitles you to a swap model on-site within 48 hours of your call being received.

An extended warranty called Philips F1rst Choice Premium is available in addition to your Philips F1rst Choice warranty. For more details contact your Philips dealer.

Before contacting Philips, please prepare the following details so we can solve your problem quickly.

- Philips type number
- Philips serial number
- Purchase date (copy of purchase may be required)
- PC environment Processor:
  - 286/386/486/Pentium Pro/Internal memory
  - Operating system (Windows, DOS, OS/2, MAC)
  - Fax/Modem/Internet program?
- Other cards installed

Having the following information available will also help speed up the process:

- Your proof of purchase indicating: date of purchase, dealer name, model and product serial number.
- The full address to which the swap model should be delivered.

### Just a phone call away

Philips' customer help desks are located worldwide. You can contact Philips Monday - Friday from 08.00 - 20.00 hrs Central European Time (CET) and on Saturdays and Sundays from 10.00 to 18.00 hrs CET by using one of the toll-free numbers. Click here to access the [F1rst Choice Contact Information](#). Or you can reach us via:

Website: <http://www.philips.com>

# Your International Guarantee

Dear Customer,

Thank you for purchasing this Philips product which has been designed and manufactured to the highest quality standards.

If, unfortunately, something should go wrong with this product Philips guarantees free of charge labor and replacement parts irrespective of the country where it is repaired during a period of 12 months from date of purchase. This international Philips guarantee complements the existing national guarantee obligations to you of dealers and Philips in the country of purchase and does not affect your statutory rights as a customer.

The Philips guarantee applies provided the product is handled properly for its intended use, in accordance with its operating instructions and upon presentation of the original invoice or cash receipt, indicating the date of purchase, dealer's name and model and production number of the product.

The Philips guarantee may not apply if:

- the documents have been altered in any way or made illegible;
- the model or production number on the product has been altered, deleted, removed or made illegible;
- repairs or product modifications and alterations have been executed by unauthorized service organizations or persons;
- damage is caused by accidents including but not limited to lightning, water or fire, misuse or neglect.

Please note that the product is not defective under this guarantee in the case where modifications become necessary in order for the product to comply with local or national technical standards which apply in countries for which the product was not originally designed and/or manufactured. Therefore always check whether a product can be used in a specific country.

In case your Philips product is not working correctly or is defective, please contact your Philips dealer. In the event you require service whilst in another country a dealer address can be given to you by the Philips Consumer Help Desk in that country, the telephone and fax number of which can be found in the relevant part of this booklet.

In order to avoid unnecessary inconvenience, we advise you to read the operating instructions carefully before contacting your dealer. If you have questions which your dealer cannot answer or any related question please contact the [Philips Consumer Information Centers](#) or via:

Website: <http://www.philips.com>

# LIMITED WARRANTY

## (Computer Monitor)

### Three Years Free Labor / Three Years Free Service on Parts / One Year Exchange\*

*\*Product will be exchanged with a new or renewed to original specifications unit within two business days for the first year. This product must be shipped in at your expense for service during years two and three.*

#### WHO IS COVERED?

You must have proof of purchase to receive warranty service. A sales receipt or other document showing that you purchased the product is considered proof of purchase. Attach it to this owner's manual and keep both nearby.

#### WHAT IS COVERED?

Warranty coverage begins the day you buy your product. *For three years thereafter*, all parts will be repaired or replaced, and labor is free. *After three years from the day of purchase*, you pay for the replacement or repair of all parts, and for all labor charges.

All parts, including repaired and replaced parts, are covered only for the original warranty period. When the warranty on the original product expires, the warranty on all replaced and repaired products and parts also expires.

#### WHAT IS EXCLUDED?

Your warranty does not cover:

- labor charges for installation or setup of the product, adjustment of customer controls on the product, and installation or repair of antenna systems outside of the product.
- product repair and/or part replacement because of misuse, accident, unauthorized repair or other cause not within the control of Philips Consumer Electronics.
- reception problems caused by signal conditions or cable or antenna systems outside the unit.
- a product that requires modification or adaptation to enable it to operate in any country other than the country for which it was designed, manufactured, approved and/or authorized, or repair of products damaged by these modifications.
- incidental or consequential damages resulting from the product. (Some states do not allow the exclusion of incidental or consequential damages, so the above exclusion may not apply to you. This includes, but is not limited to, prerecorded material, whether copyrighted or not copyrighted.)
- a product used for commercial or institutional purposes.

## Where IS SERVICE AVAILABLE?

Warranty service is available in all countries where the product is officially distributed by Philips Consumer Electronics. In countries where Philips Consumer Electronics does not distribute the product, the local Philips service organization will attempt to provide service (although there may be a delay if the appropriate spare parts and technical manual(s) are not readily available).

## Where CAN I GET MORE INFORMATION?

For more information, contact the Philips Customer Care Center by calling [\(877\) 835-1838 \(U.S.A. customers only\)](tel:8778351838) or [\(903\) 242-4804](tel:9032424804).

### *Before Requesting Service...*

Please check your owner's manual before requesting service. Adjustments of the controls discussed there may save you a service call.

## TO GET WARRANTY SERVICE IN U.S.A., PUERTO RICO OR U.S. VIRGIN ISLANDS...

Contact the Philips Customer Care Center phone number listed below for product assistance and procedures for servicing:

*Philips Customer Care Center*

*(877) 835-1838 or (903) 242-4804*

*(In U.S.A., Puerto Rico and U.S. Virgin Islands, all implied warranties, including implied warranties of merchantability and fitness for a particular purpose, are limited in duration to the duration of this express warranty. But, because some states do not allow limitations on how long an implied warranty may last, this limitation may not apply to you.)*

## TO GET WARRANTY SERVICE IN CANADA...

Please contact Philips at:

*(800) 479-6696*

Three years free parts and three years free labor will be provided at Philips Canada depot or any one of its authorized service centers.

*(In Canada, this warranty is given in lieu of all other warranties. No other warranties are expressed or implied, including any implied warranties of merchantability or fitness for a particular purpose. Philips is not liable under any circumstances for any direct, indirect, special, incidental or consequential damages, howsoever incurred, even if notified of the possibility of such damages.)*

**REMEMBER...** Please record the model and serial numbers found on the product below.

MODEL # \_\_\_\_\_

SERIAL # \_\_\_\_\_

*This warranty gives you specific legal rights. You may have other rights which vary from state/province to state/province.*

Philips Customer Care Center, P. O. Box 2976, Longview, TX 75601

---

## Your International Philips F1rst Choice Warranty

Thank you for purchasing this Philips monitor.



All Philips monitors are designed and manufactured to high standards and deliver high-quality performance, ease of use and ease of installation. Should you encounter any difficulties while installing or using this product, please contact Philips directly to benefit from your Philips F1rst Choice Warranty. This three-year service warranty entitles you to a swap model on-site within 48 hours of your call being received within the first year of purchase. If you have any problems with your monitor within the second or third year of purchase, we will repair it after it has been sent to the service provider at your expense and returned to you within five working days, free of charge.

An extended warranty called Philips F1rst Choice Premium is available in addition to your Philips F1rst Choice warranty. For more details contact your Philips dealer.

Before contacting Philips, please prepare the following details so we can solve your problem quickly.

- Philips type number
- Philips serial number
- Purchase date (copy of purchase may be required)
- PC environment Processor:
  - 286/386/486/Pentium Pro/Internal memory
  - Operating system (Windows, DOS, OS/2, MAC)
  - Fax/Modem/Internet program?
- Other cards installed

Having the following information available will also help speed up the process:

- Your proof of purchase indicating: date of purchase, dealer name, model and product serial number.
- The full address to which the swap model should be delivered.

## Just a phone call away

Philips' customer help desks are located worldwide. You can contact Philips Monday - Friday from 08.00 - 20.00 hrs Central European Time (CET) and on Saturdays and Sundays from 10.00 to 18.00 hrs CET by using one of the toll-free numbers. Click here to access the [F1rst Choice Contact Information](#). Or you can reach us via:

Website: <http://www.philips.com>